

CONTACT

LAMP SHINING MANUFACTURING CO.,LTD



william@lampshining.com
sales@lampshining.com



0086-13612945445



0086-13612945445



0086-13612945445



lampshining87



www.lampshining.com



4th floor Building K Yuanling Zhixuanhan industrial Area Yuanmei
communityShiyan Town Bao'an District,Shenzhen China

ABOUT US

Lamp Shining Manufacturing Co.,Ltd was founded in 2010 who has been specializing in developing,manufacturing and selling LED lamps, we have won high reputation from our oversea clients.We have been focusing on the USA ,Europe and Australia markets. We are constantly developing and manufacturing new LED luminaires according to the needs of our customers and the needs of the environment, so we are always in the leading position in the industry.

Lampshining professional manufactures and sells LED lighting lamps. Including LED street lights, sports stadium lights, High Mast Light, high Bay Light, wall pack, corn bulb, landscape light, flood light. This product is suitable for global commercial and industrial indoor and outdoor LED lighting. Industry-leading quality, Lightweight, easy to install, 5 years warranty. And our products have passed ENEC, ENEC+,DLC, ETL, TUV, CE, IECEE, CB, RoHS, LM78, LM80, LSTMT, TM21, Salt Spray Test.

LAMP SHINING®

WWW.LAMP SHINING.COM

LAMP SHINING MANUFACTURING CO.,LTD

SHENZHEN LAMP SHINING TECHNOLOGY CO.,LTD



E-Catalogue



2024-2025 Products Catalogs

LAMP SHINING®
WWW.LAMP SHINING.COM

Catalog

LED HIGH MAST LIGHT / LED STADIUM LIGHTING



P5-6
PRO
LED HIGH MAST LIGHTS
100W-1440W



P7-8 **NEW**
PLUS SKD
LED HIGH MAST LIGHTS
150W-1200W



P9-10
PROE
LED HIGH MAST LIGHTS
50W-240W



P11-12 **NEW**
MAX
LED HIGH MAST LIGHTS
400W-1800W



P13-14 **NEW**
ULTRA
LED STADIUM LIGHTS
150W-1800W



P15-16 **NEW**
ULTRA-Z
LED HIGH MAST LIGHTS
500W-1800W



P17-18 **NEW**
PROX
LED HIGH MAST LIGHTS
480W-1440W



P19-20
ROUND
LED STADIUM LIGHTS
400W-1200W



P21-22
ALPHA
LED STADIUM LIGHTS
500W-1200W



P23-24
DRAGONFLY
LED HIGH MAST LIGHTS
240W-1800W



P25-26
DRAGONFLY MAX
LED STADIUM LIGHTS
240W-1800W



P27-28
TRANSFORMER
LED HIGH MAST LIGHTS
400W-1440W



P29-30
ULTRA
LED HIGH MAST LIGHTS
400W-1800W

LED CONVEYOR LIGHT



P33-34
LED Conveyor Light
30W-70W

LED POST TOP LIGHTS



P35-36
SKYSCRAPER
LED POST TOP LIGHT
30W-150W



P37-38
SKYSCRAPER
LED POST TOP LIGHT
Wattage CCT Adjustable



P39-40
SKYLINE
LED POST TOP LIGHT
30W-150W



P41-42
SKYLINE
LED POST TOP LIGHT
Wattage CCT Adjustable

LED STREET LIGHTS



P43-44
MARS
LED STREET LIGHTS
10W-200W



P45-48
PLUTO
LED STREET LIGHTS
10W-300W



P49-50
SATURN
LED STREET LIGHTS
30W-200W

LED HIGH BAY LIGHTS



P51-52 **NEW**
FOOD GRADE
LED HIGH BAY LIGHT
100W-200W



P53-54 **NEW**
DIP WATTAGE SWITCHABLE
LED HIGH BAY LIGHT
100W-200W



P55-56 **NEW**
HIGH TEMPERATURE
LED HIGH BAY LIGHT
100W-200W



P57-58 **NEW**
ANTI CORROSION
LED HIGH BAY LIGHT
100W-200W



P59-60
6th GEN
UFO LED HIGH BAY LIGHT
100W-500W



P61-62
Wattage/CCT Adjustable
UFO LED HIGH BAY LIGHT
100W-240W



P61-62
3rd GEN MOTION SENSOR
UFO LED HIGH BAY LIGHT
100W-300W



P63-64
Linear
LED HIGH BAY LIGHTS
50W-500W

LED FLOOD LIGHTS



P65-66
NEMO
LED FLOOD LIGHTS
100W-720W



P67-68
NEMO EKO
LED FLOOD LIGHTS
50W-200W



P69-70 **NEW**
EKO
LED FLOOD LIGHTS
50W-600W

LED FIN MODULE LIGHT



P71-72
PROE
LED FIN MODULE LIGHT
50W



P73-74
PROA
LED FIN MODULE LIGHT
100W 120W



P75-76
PROB
LED FIN MODULE LIGHT
200W 240W



P77-78
PLUS
LED FIN MODULE LIGHT
200W 240W 300W



P79-80
MAX
LED FIN MODULE LIGHT
240W 300W



P81-82 **NEW**
Ultra
LED FIN MODULE LIGHT
500W 600W

LED SHOEBOX LIGHTS / LED RETROFIT KITS / LED CORN BULBS / SKD / Project Case



P83
SHOEBOX SERIES
LED SHOEBOX LIGHTS
100W-300W



P84
HEXAGON
LED RETROFIT KITS
30W-150W



P85-86
ALUMINUM FINS
LED CORN BULBS
20W-240W

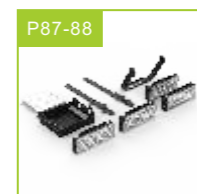

P87-88
SKD
Semi-Knock Down Kit
All products in this catalog



P89-90
Project Case

CERTIFICATION

Certification

We have certified DLC, ETL, TUV, SAA, CE, RoHS, ENEC, CB, IECEE, and more than 250 products have received DLC certification. The lighting efficiency is up to 160Lm/W. Suitable for the global lighting market.



Europe Patent design



EXHIBITION

Hong Kong Spring Lighting Fair



Hong Kong Autumn Lighting Fair



Panama Lighting Fair



EXHIBITION

INTERNATIONAL LIGHT FAIR



SHIPMENT



Our main business are in Europe and USA market, We have distributors in the US. Most of our Products are made of semi-materials to meet the delivery time of fast production. We have 3 production lines with over 30 quality controls and workers to meet our fast delivery times and quality. Samples take 1-3 days, and bulk orders take only 10-15 days.

HOW WE CUSTOMIZE YOUR LED LIGHTS

We will keep you informed of every step and involved in every decision to create a product we know will bring you the most benefits.



1 Customized product requirement



2 Evaluation on the requirement by R & D team



3 Product proposal including quotation and drawing offered in 7 days



4 New product prototype can be provided for confirmation in 7 days



5 Discuss any question on the new product prototype



6 Start on new tools trial production mass production which takes around 20-50 days

- FLAME RETARDED
- SALT SPRAY TEST
- 100-277V
- 347-480V
- Dimmable
- L90B10 >100,000hours
- Adjust 270°
- 30~45°C
- IK10
- IP66
- Folding Aluminum Fin

PRO

LED HIGH MAST LIGHT 100W-1440W

Folding Aluminum Fin
High pure thermal conductive module Folding Aluminum Fin Heat sink is made with high pressure Folding technology.

Professional optics
The optical lens is made of PC, and the transmittance reaches 92%, reducing light loss, maximize the lumens on where it should be lit up and evenness, minimize lighting pollution to nature and human life.

Module Rotatable
Module Rotatable ±25°
Separate module can be mounted on the same robust bracket to offer the utmost flexibility.

Installation Versatility
The fixing bracket is made of high-strength material and is bent at an angle of 45° to make the lamp body better installed.

GR<45 **U0 0.8**

- No overflow upward lights
- No light pollution to sky
- No light pollution to audiences or neighbors' space
- Low Glare Rating GR<45
- Uniformity(U0) up to 0.8

Model None Rotatable **Module Rotatable ±25°**

- All Applications**
 - Uniformity and light quality
 - Light pollution and spillage
 - Controls
- Baseball, Softball**
 - High levels of illumination
 - Lighted from all sides
 - Reducing glare
- Harbors, Wharfs**
 - Pole location (primarily sidelines)
 - Pole quantity
 - Number of fixtures per pole
- Soccer, Lacrosse, Mixed Use**
 - Pole location
 - Pole quantity
 - Number of fixtures per pole
- Basketball, Tennis**
 - Floodlight, or area-style fixtures
 - Court configuration (grouping)
 - Court access



PRO

LED HIGH MAST LIGHT & STADIUM FLOOD LIGHTS

190 Lm/W

- Light Source: Lumileds 5050 • Housing: Marine grade aluminum
- Input Volt: 100-277VAC / 374-480V
- Color Temp: 3000K 4000K 5000K 5700K
- IK & IP RATING : IK10 IP66 • 5 years warranty
- Beam Angle: Symmetrical 10° / 20° / 40° / 60° / 90° Asymmetrical: 140*100° P50 P65 P60-L

Model	Watt	Lumen	Efficiency	Input Volt	Size	Driver	Weight
LSHM-100W-LV(XXX)	100W	19,000Lm	160~190Lm/w±5%	100-277Vac	297x263x132mm	Meanwell Sosen Driver	2.2kg
LSHM-120W-LV(XXX)	120W	22,200Lm	155~185Lm/w±5%	100-277Vac			2.2kg
LSHM-200W-LV(XXX)	200W	38,000Lm	160~190Lm/w±5%	100-277Vac	342x362x132mm		5.5kg
LSHM-240W-LV(XXX)	240W	44,400Lm	155~185Lm/w±5%	100-277Vac			7.5kg
LSHM-300W-LV(XXX)	300W	57,000Lm	160~190Lm/w±5%	100-277Vac	475x362x132mm		7.5kg
LSHM-400W-LV(XXX)	400W	76,000Lm	160~190Lm/w±5%	100-277Vac	597x362x132mm		10kg
LSHM-480W-LV(XXX)	480W	88,800Lm	155~185Lm/w±5%	100-277Vac			10kg
LSHM-B400W-LV(XXX)	400W	76,000Lm	160~190Lm/w±5%	100-277Vac	529x362x188mm		10kg
LSHM-B480W-LV(XXX)	480W	88,800Lm	160~185Lm/w±5%	100-277Vac			10kg
LSHM-B600W-LV(XXX)	600W	114,000Lm	160~190Lm/w±5%	100-277Vac	649x375x188mm		12.5kg
LSHM-B720W-LV(XXX)	720W	133,200Lm	160~185Lm/w±5%	100-277Vac			12.5kg
LSHM-B800W-LV(XXX)	800W	144,000Lm	160~190Lm/w±5%	100-277Vac	650x597x188mm		16kg
LSHM-B1000W-LV(XXX)	1000W	185,000Lm	160~185Lm/w±5%	100-277Vac			16kg
LSHM-B1200W-LV(XXX)	1200W	222,000Lm	160~185Lm/w±5%	100-277Vac	729x650x188mm		20kg
LSHM-B1440W-LV(XXX)	1440W	266,400Lm	160~185Lm/w±5%	100-277Vac	860x650x188mm	22kg	

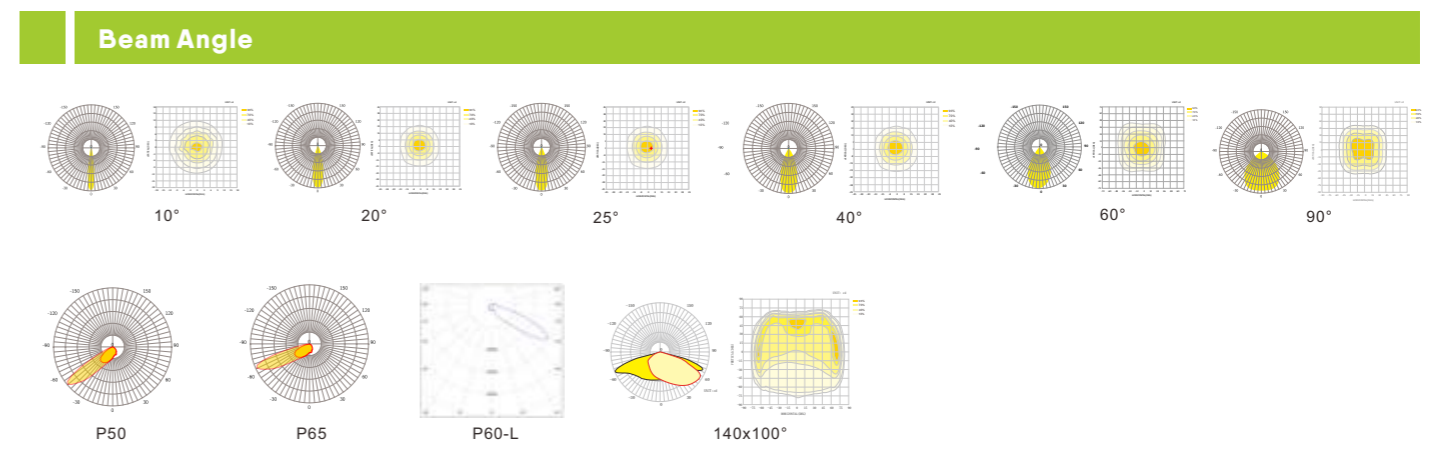

SKD

SEMI-KNOCK DOWN KIT

SKD Available to Save Maximum Stocks

Easily complete the local manufacturing of finished LED lamps and obtain higher profits.



Simple and quick to assemble



Be friendly to back-up



Faster delivery time to end-user



Locally made is more valuable



Add-on AC led module



Add on 10kv or 20kv SPD

2-Module 300W 400W 480W



3-Module 450W/600W/720W



4-Module 600W/800W/960W

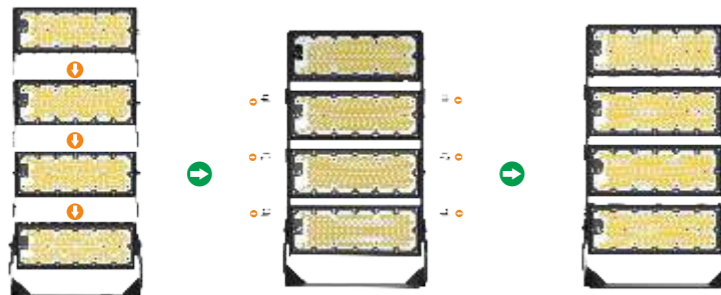

5-Module 750W/1000W/1200W

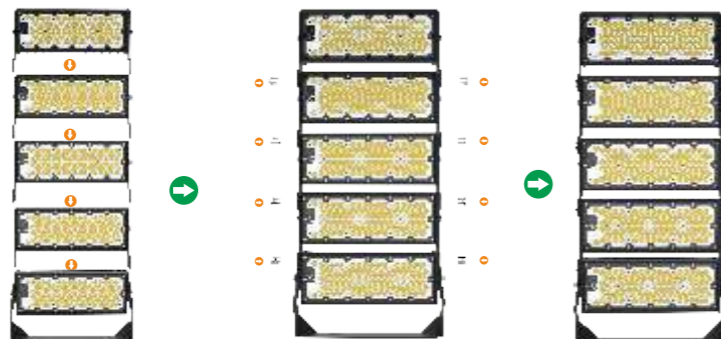

PLUS SKD LED HIGH MAST LIGHTS

180 Lm/W

- Light Source: Lumileds 5050
- Input Volt: 100-277VAC / 347-480VAC
- IP & IK Rating : IP66 & IK10
- Lifespan: L90B10>100,000hrs
- CRI: Ra>70 ,Optional with Ra>80 or Ra>90
- SPD: 10KV / 20KV
- Beam Angle: Symmetrical 20° / 40° / 60° / 90°
- Beam Angle: Asymmetrical P50
- Color Temp: 3000K~6000K
- 5 years warranty



100-277V



347-480V



Dimmable



L90B10
>100,000hrs



Adjust
270°



-40~55°C



IK10



IP66



Folding Aluminum Fin

Model	Watt	Efficiency	Lumen	Driver	Efficiency P50	Lumen
LSHM-150W-(XXK)PLUS	150W	165lm/w±5%	24,750Lm	Inventronics / Meanwell/ Lifud	155lm/w±5%	23,250Lm
LSHM-200W-(XXK)PLUS	200W	160lm/w±5%	32,000Lm	Inventronics / Meanwell/ Lifud	150lm/w±5%	30,000Lm
LSHM-240W-(XXK)PLUS	240W	155lm/w±5%	37,200Lm	Inventronics / Meanwell/ Lifud	145lm/w±5%	34,800Lm
LSHM-150W-(XXK)PLUS	150W	180lm/w±5%	27,000Lm	Inventronics / Meanwell/ Lifud	170lm/w±5%	25,500Lm
LSHM-200W-(XXK)PLUS	200W	175lm/w±5%	35,000Lm	Inventronics / Meanwell/ Lifud	165lm/w±5%	33,000Lm
LSHM-240W-(XXK)PLUS	240W	170lm/w±5%	40,800Lm	Inventronics / Meanwell/ Lifud	160lm/w±5%	38,400Lm



Beam Angle

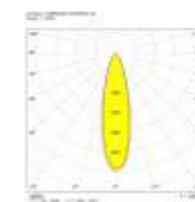

20°

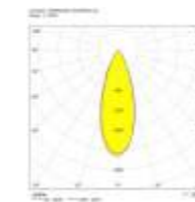

40°

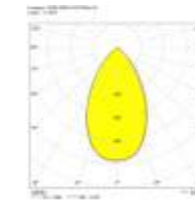

60°

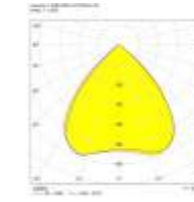

90°

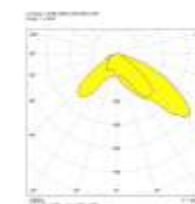

P50



PRO E

LED HIGH MAST LIGHT 50W-240W

170 Lm/W



PRO E

LED HIGH MAST LIGHT & STADIUM FLOOD LIGHTS

- Light Source: Luminleds 3030
- Input Volt: 100-277Vac
- IP Rating IK Rating: IP66 & IK10
- Beam Angle: 15° 25° 40° 60° 90° 120°
30x70° 49x21° 136x78°
- Color Temp: 3000K 4000K 5000K 5700K 6000K
- 5 years warranty

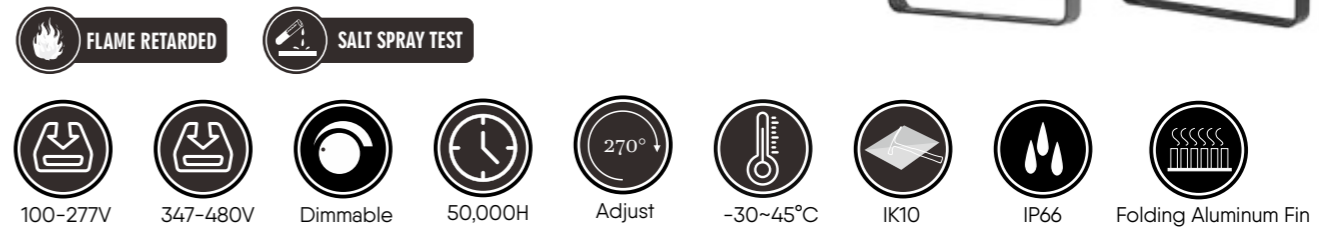

Technical Specifications

Model	Watt	Efficiency #1	Lumen #1	Efficiency #2	Lumen #2	Driver	Net Weight
LSHM-50W-LV(XXX)ProE	50W	140LM/W±3%	7,000Lm	170LM/W±3%	8,500Lm	SS-50VA-56	1.4kg
LSHM-100W-LV(XXX)ProE	100W	140LM/W±3%	14,000Lm	170LM/W±3%	17,000Lm	XLG-100-H-A	2.7KG
LSHM-150W-LV(XXX)ProE	150W	140LM/W±3%	21,000Lm	170LM/W±3%	25,500Lm	XLG-150-H-A	3.5KG
LSHM-200W-LV(XXX)ProE	200W	140LM/W±3%	28,000Lm	170LM/W±3%	34,000Lm	XLG-240-H-A	4.2KG
LSHM-240W-LV(XXX)ProE	240W	140LM/W±3%	33,600Lm	170LM/W±3%	40,800Lm	XLG-240-H-A	4.8KG



Wall Installation



Ground Installation



Pole Installation

Beam Angle

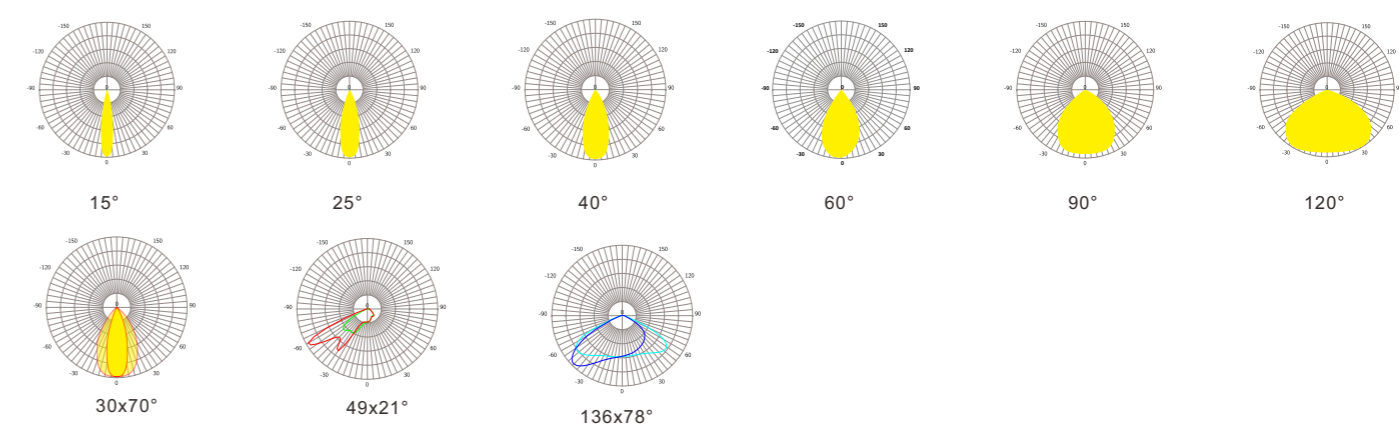

PRO E

Slim ProE LED Flood Light

140LM/W 170LM/W

50W 100W 150W 200W 240W

Folding Aluminum fin design which are very light weight. Increase the heat dissipation surface area by air cooling to dissipate heat and expand the contact area with air! It speeds up the spread of heat! Thermal effect is good!



175 Lm/W

MAX

LED HIGH MAST LIGHT 400W-1800W



MAX SERIES LED HIGH MAST LIGHT

MAX outdoor pole LED sport flood lighting fixtures replace traditional lighting fixtures and can immediately improve the quality of lighting in stadiums, large areas, roads, ports, and airports, and reduce energy consumption by as much as 75%.



All Applications

- Uniformity and light quality
- Light pollution and spillage
- Controls



Soccer Lacrosse, Mixed Use

- Pole location
- Pole quantity
- Number of fixtures per pole



Baseball, Softball

- High levels of illumination
- Lighted from all sides
- Reducing glare



Basketball, Tennis

- Floodlight, or area-style fixtures
- Court configuration (grouping)
- Court access



Harbors, Wharfs

- Pole location (primarily sidelines)
- Pole quantity
- Number of fixtures per pole

MAX LED High Mast Light

Floodlight for large area and sports lighting

- Light Source: Luminleds 5050
- Input Volt: 100~277Vac Or 198~440Vac
- IP Rating IK Rating : IP66 & IK10
- Symmetrical Angle: 10° 15° 20° 40° 60° 90°
- Asymmetrical Angle: P60
- Color Temp: 3000K~ 6000K
- Surge Protection: 10KV (optional 20KV)
- Fuction: Dali2.0 & DMX (optional)
- 5 years warranty

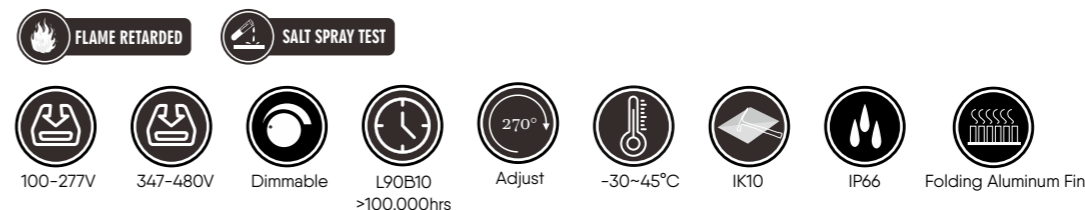

Model	Watt	Efficiency	Lumen	Efficiency	Lumen	Weight
LSHM-400W(XXX)MAX	400W	165lm/w±5%	66,000Lm	175lm/w±5%	70,000Lm	9.63Kg
LSHM-500W(XXX)MAX	500W	165lm/w±5%	82,500Lm	175lm/w±5%	87,500Lm	9.63Kg
LSHM-600W(XXX)MAX	600W	155lm/w±5%	93,000Lm	165lm/w±5%	99,000Lm	9.63Kg
LSHM-900W(XXX)MAX	900W	165lm/w±5%	148,500Lm	175lm/w±5%	157,500Lm	17.5Kg
LSHM-1000W(XXX)MAX	1000W	165lm/w±5%	165,000Lm	175lm/w±5%	165,000Lm	17.5Kg
LSHM-1200W(XXX)MAX	1200W	155lm/w±5%	186,000Lm	165lm/w±5%	198,000Lm	17.5Kg
LSHM-1500W(XXX)MAX	1500W	165lm/w±5%	247,500Lm	175lm/w±5%	247,500Lm	21.9Kg
LSHM-1800W(XXX)MAX	1800W	155lm/w±5%	279,000Lm	165lm/w±5%	297,000Lm	21.9Kg

600W 1200W 1800W are not available with P60 lense

Beam Angle

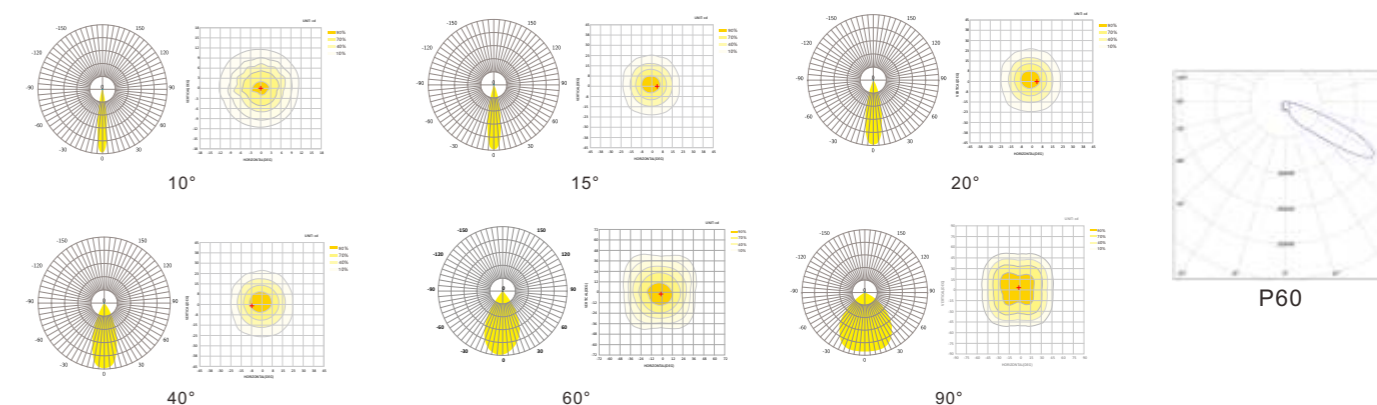

EASY Combination

Asymmetric Optical Lenses

Asymmetric P50-L & P60-L Produce low Glare Rating GR<45
Lights were forwarded further away which produces a higher uniformity (U0) up to 0.8

Asymmetric P50-L & P60-L Optic allows lamp to be installed horizontally No overflow upward lights which emits no light pollution to sky, no light pollution to audiences or neighbors' space



- No overflow upward lights
- No light pollution to sky
- No light pollution to audiences or neighbors' space
- Low Glare Rating GR<45
- Uniformity(U0) up to 0.8

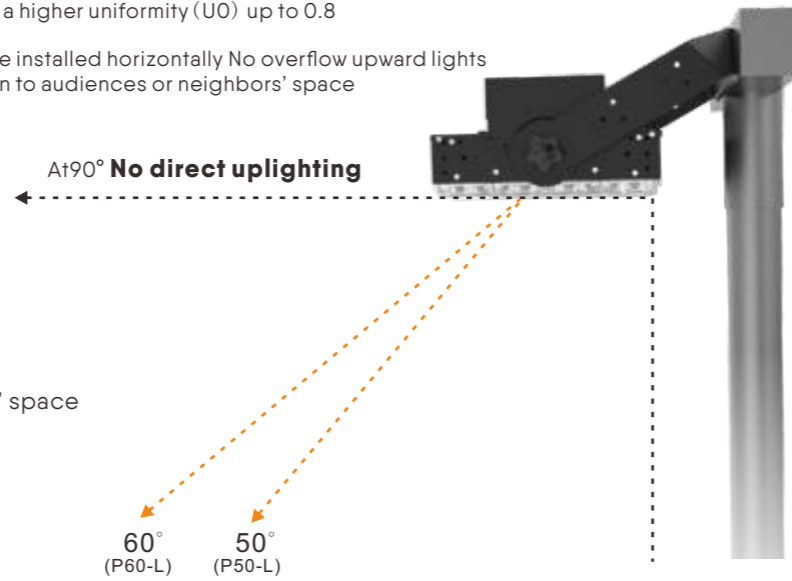

- Facilitate inventory and reduce inventory pressure.
- Easy maintenance and quick update of modules.

Ultra LED high mast lights 500W 600W two power, through the link piece can be quickly assembled into two modules 1000W 1200W, three modules 1440W 1800W, which means that only need to stock Ultra LED high mast lights plus the link piece can meet the needs of six kinds of power, the demand for application scenarios can be quickly responded to.



2pcs built into one piece 400W & 480W & 600W

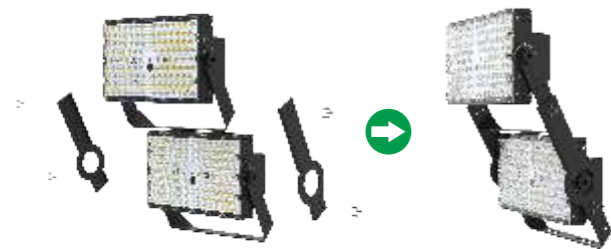

3pcs built into one piece 600W & 720W & 900W

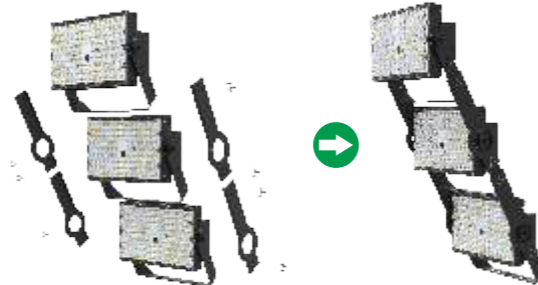

2pcs built into one piece 800W & 1000W & 1200W

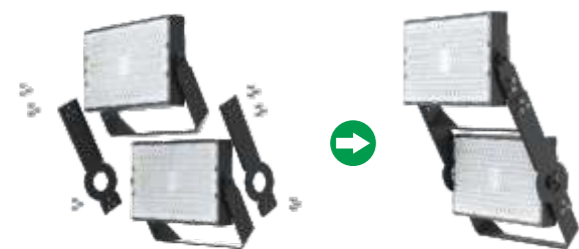

3pcs built into one piece 1200W & 1500W & 1800W

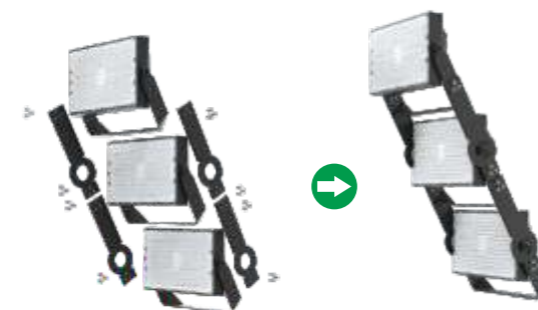

ULTRA LED HIGH MAST LIGHTS

190 Lm/W

- Light Source: Lumileds 5050
- Input Volt: 100-277VAC / 347-480VAC
- IP & IK Rating : IP66 & IK10
- Lifespan: L90B10>100,000hrs
- Function: Dali2.0 & DMX
- SPD: 10KV
- Beam Angle: Symmetrical 10° / 15° / 20° / 40° / 60° / 90°
- Beam Angle: Asymmetrical P50-L / P60-L
- Color Temp: 3000K~6000K
- 5 years warranty

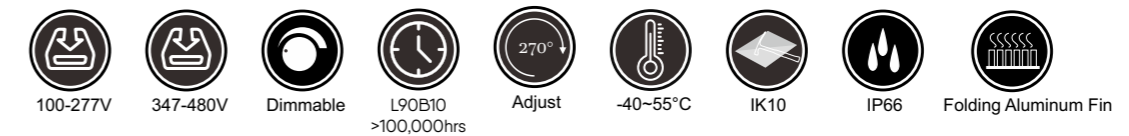

Model	Watt	Efficiency #1	Lumen #1	Efficiency#2	Lumen#2	Bracket Materials	Weight
LSHM-200W(XXX)Ultra	200W	175lm/w±5%	35,000Lm	190lm/w±5%	39,000Lm	Iron	5.9kg
LSHM-240W(XXX)Ultra	240W	170lm/w±5%	40,800Lm	185lm/w±5%	44,400Lm	Iron	5.9kg
LSHM-300W(XXX)Ultra	300W	165lm/w±5%	49,500Lm	180lm/w±5%	54,000Lm	Iron	5.9kg
LSHM-400W(XXX)Ultra	400W	170lm/w±5%	68,000Lm	185lm/w±5%	74,000Lm	Iron	11.8kg
LSHM-500W(XXX)Ultra	500W	170lm/w±5%	85,000Lm	185lm/w±5%	92,500Lm	Iron	11.8kg
LSHM-600W(XXX)Ultra	600W	165lm/w±5%	99,000Lm	180lm/w±5%	108,000Lm	Iron	11.8kg
LSHM-900W(XXX)Ultra-S	900W	165lm/w±5%	148,500Lm	175lm/w±5%	157,500Lm	Iron	17.2kg
LSHM-1000W(XXX)Ultra-S	1000W	165lm/w±5%	160,000Lm	170lm/w±5%	170,000Lm	Iron	17.2kg
LSHM-1200W(XXX)Ultra-S	1200W	150lm/w±5%	180,000Lm	160lm/w±5%	192,000Lm	Iron	17.2kg
LSHM-1500W(XXX)Ultra-S	1500W	170lm/w±5%	255,000Lm	180lm/w±5%	270,000Lm	Iron	/
LSHM-1650W(XXX)Ultra-S	1650W	165lm/w±5%	272,250Lm	175lm/w±5%	288,750Lm	Aluminum die casting	/
LSHM-1800W(XXX)Ultra-S	1800W	160lm/w±5%	288,000Lm	170lm/w±5%	306,000Lm	Aluminum die casting	/
LSHM-1000W(XXX)Ultra	1000W	170lm/w±5%	170,000Lm	185lm/w±5%	185,000Lm	Aluminum die casting	18.5kg
LSHM-1200W(XXX)Ultra	1200W	165lm/w±5%	198,000Lm	180lm/w±5%	216,000Lm	Aluminum die casting	18.5kg
LSHM-1500W(XXX)Ultra	1500W	170lm/w±5%	255,000Lm	185lm/w±5%	277,500Lm	Aluminum die casting	27.88kg
LSHM-1800W(XXX)Ultra	1800W	165lm/w±5%	297,000Lm	180lm/w±5%	32,400Lm	Aluminum die casting	27.88kg

The above mounting bracket is standard, optional aluminum die-casting bracket and 316 stainless steel bracket are available.

Beam Angle

Symmetrical

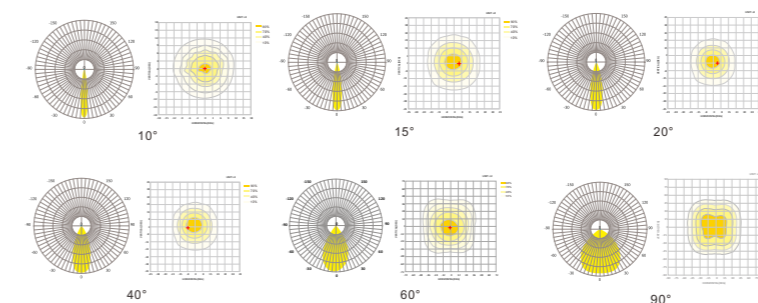

Asymmetrical

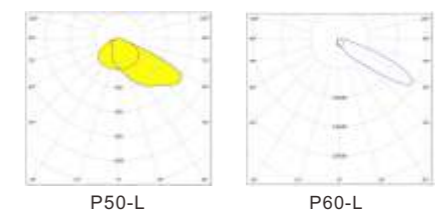



STADIUMS
ARENAS



OUTDOOR SPORTS



MULTI SPORTS
HALLS



SWIMMING
POOLS



HARBOR
WHARF



AIRPORTS

Folding aluminum fin design which is very light weight which makes Ultra-z lighter and smaller. Which both improves installation safety and reduces maintenance

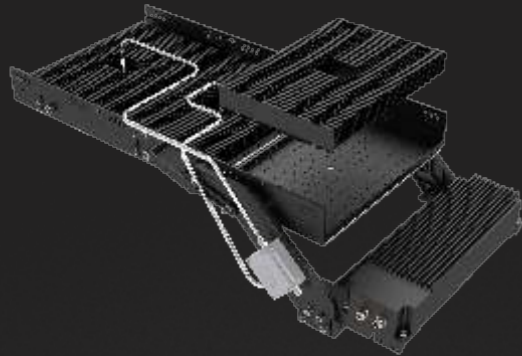

GR<45



U0 0.8

- No overflow upward lights
- No light pollution to sky
- No light pollution to audiences or neighbors' space
- Low Glare Rating GR<45
- Uniformity(U0) up to 0.8

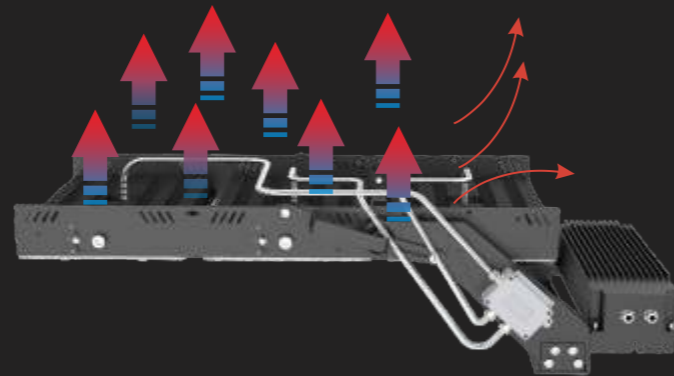

Intelligent Dimming Control System



Different from other typical fittings that fastened by one iron screw and nut, it uses AISI316 parts to fasten the fitting and bracket. Passed wind speed test >60m/s. Resist up to level-17 hurricane.



ULTRA-Z

LED HIGH MAST LIGHTS

190 Lm/W



- Light Source: Lumileds 5050
- Input Volt: 198~528Vac 198~440Vac
- IP & IK Rating : IP66 & IK10
- Lifespan: L90B10>100,000hrs
- Function: Dali2.0 & DMX
- SPD: 10KV
- Beam Angle: Symmetrical 10° / 20° / 40° / 60°
- Beam Angle: Asymmetrical P50-L / P60-L
- Color Temp: 3000K~6000K
- 5 years warranty



100-277V



347-480V



Dimmable



L90B10
>100,000hrs



Adjust



-40~55°C



IK10



IP66



Folding Aluminum Fin

Model	Watt	Efficiency	Lumen	Efficiency	Lumen	Bracket Materials	Weight
LSHM-500W(XXX)Ultra-Z	500W	170lm/w±5%	85,000Lm	185lm/w±5%	92,500Lm	Aluminum die casting	11.6kg
LSHM-600W(XXX)Ultra-Z	600W	165lm/w±5%	99,000Lm	180lm/w±5%	108,000Lm	Aluminum die casting	11.6kg
LSHM-900W(XXX)Ultra-SZ	900W	165lm/w±5%	148,500Lm	175lm/w±5%	157,500Lm	Aluminum die casting	15kg
LSHM-1000W(XXX)Ultra-SZ	1000W	160lm/w±5%	160,000Lm	170lm/w±5%	170,000Lm	Aluminum die casting	15kg
LSHM-1200W(XXX)Ultra-SZ	1200W	150lm/w±5%	180,000Lm	160lm/w±5%	192,000Lm	Aluminum die casting	15kg
LSHM-1000W(XXX)Ultra-Z	1000W	170lm/w±5%	170,000Lm	185lm/w±5%	185,000Lm	Aluminum die casting	21.9kg
LSHM-1200W(XXX)Ultra-Z	1200W	165lm/w±5%	198,000Lm	180lm/w±5%	216,000Lm	Aluminum die casting	21.9kg
LSHM-1500W(XXX)Ultra-Z	1500W	170lm/w±5%	255,000Lm	185lm/w±5%	277,500Lm	Aluminum die casting	28.1kg
LSHM-1800W(XXX)Ultra-Z	1800W	165lm/w±5%	297,000Lm	180lm/w±5%	324,000Lm	Aluminum die casting	28.1kg

Beam Angle

Symmetrical

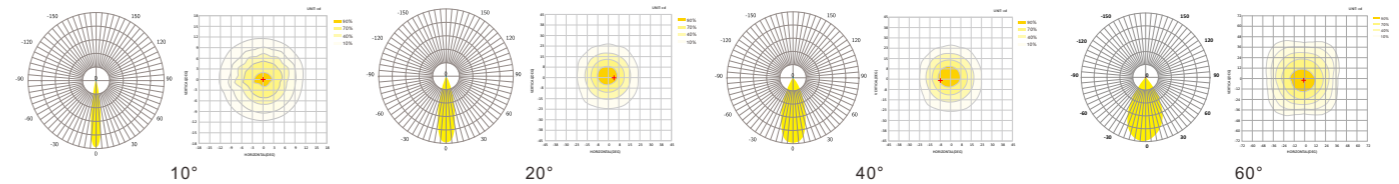

Asymmetrical

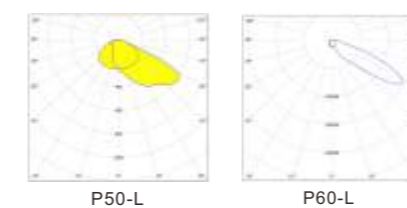



STADIUMS
ARENAS



OUTDOOR SPORTS



MULTI SPORTS
HALLS



SWIMMING
POOLS



HARBOR
WHARF



AIRPORTS

Folding aluminum fin design which is very light weight which makes PROX lighter and smaller. Which both improves installation safety and reduces maintenance

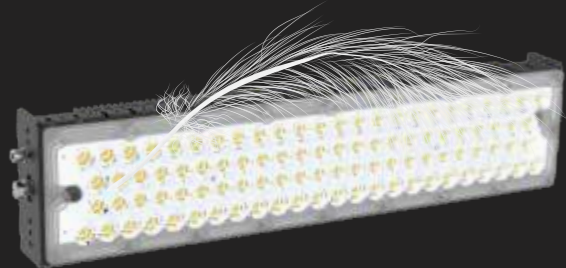

GR<45



U0 0.8

- No overflow upward lights
- No light pollution to sky
- No light pollution to audiences or neighbors' space
- Low Glare Rating GR<45
- Uniformity(U0) up to 0.8

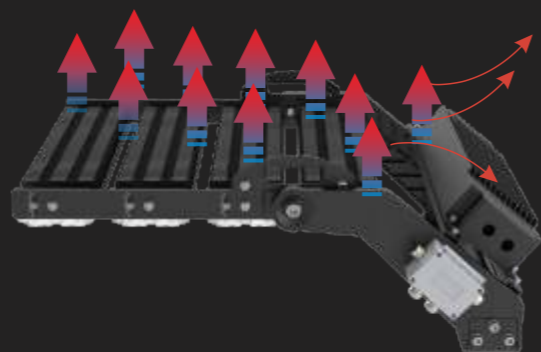

Intelligent Dimming Control System



Different from other typical fittings that fastened by one iron screw and nut, it uses AISI316 parts to fasten the fitting and bracket. Passed wind speed test >60m/s. Resist up to level-17 hurricane.



Remote Driver

Remote drivers can be located up to 300m from luminaire

PROX

LED HIGH MAST LIGHTS

- Light Source: Lumileds 5050
- Input Volt: 198~528VAC
- IP & IK Rating : IP66 & IK10
- Glare Rating: <45
- Fuction: Dali2.0 & DMX
- SPD: 10KV
- Beam Angle: Symmetrical 10° / 20° / 40° / 60° / 90°
- Beam Angle: Asymmetrical P50 / P60 / P60-L
- Color Temp: 3000K~6000K
- 5 years warranty

190 Lm/W



100-277V



347-480V



Dimmable



L90B10
>100,00hrs



Adjust
270°



-40~55°C



IK10



IP66



Folding Aluminum Fin

Model	Watt	Efficiency #1	Lumen	Efficiency#2	Lumen	Efficiency#3	Lumen	Weight
LSHM-480W-LV(XXK)ProX	480W	160Lm/w±3%	76,800Lm	170lm/w±3%	81,600Lm	200Lm/w±3%	80,000Lm	12.6kg
LSHM-600W-LV(XXK)ProX	600W	160Lm/w±3%	96,000Lm	175lm/w±3%	105,000Lm	190Lm/w±5%	91,200Lm	14.75kg
LSHM-720W-LV(XXK)ProX	720W	155Lm/w±3%	116,000Lm	170lm/w±3%	122,400Lm	200Lm/w±5%	120,000Lm	17.25kg
LSHM-900W-LV(XXK)ProX	900W	160Lm/w±3%	144,000Lm	175lm/w±3%	157,500Lm	190Lm/w±5%	136,800Lm	19.4kg
LSHM-1000W-LV(XXK)ProX	1000W	160Lm/w±3%	160,000Lm	170lm/w±3%	170,000Lm	190Lm/w±5%	190,000Lm	19.45kg
LSHM-1440W-LV(XXK)ProX	1440W	160Lm/w±3%	230,400Lm	170lm/w±3%	252,000Lm	190Lm/w±5%	228,000Lm	23.7kg

Beam Angle

Symmetrical

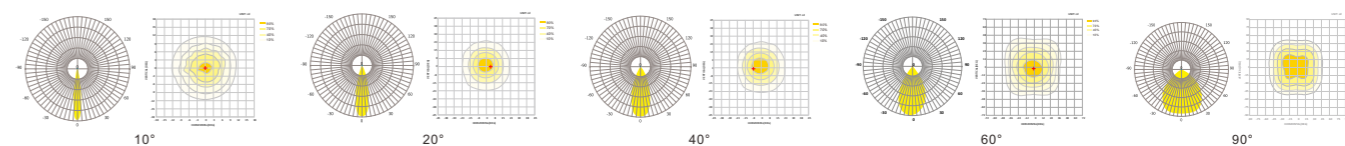

Asymmetrical

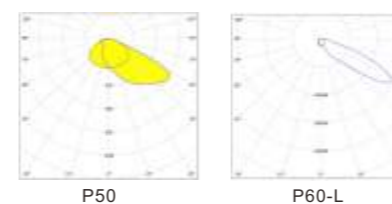



STADIUMS
ARENAS



OUTDOOR SPORTS



MULTI SPORTS
HALLS



SWIMMING
POOLS



HARBOR
WHARF



AIRPORTS



Intelligent Dimming Control System



Different from other typical fittings that fastened by one iron screw and nut, it uses AISI316 parts to fasten the fitting and bracket. Passed wind speed test >60m/s. Resist up to level-17 hurricane.

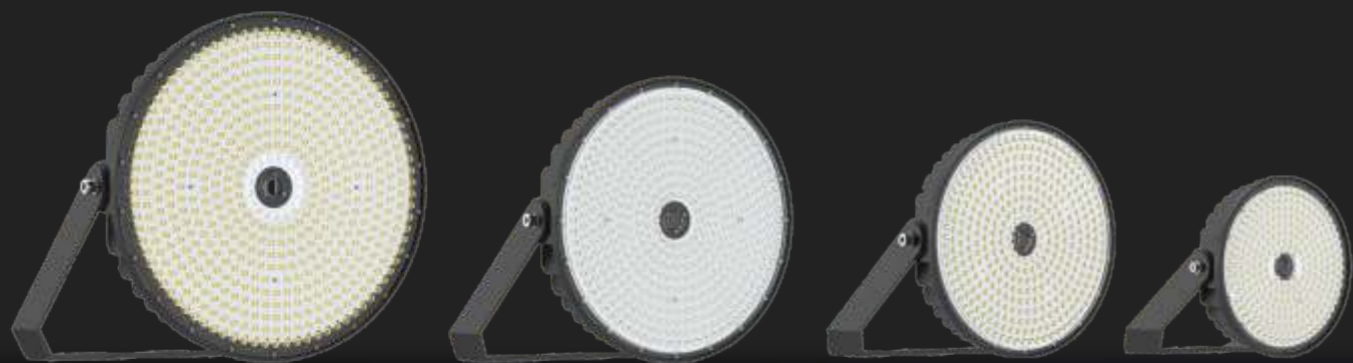

Aluminum die casting
tunion bracket



With openable
driver box(Black color)



Anti glare visor

ROUND LED HIGH MAST LIGHTS

175 Lm/W

- Light Source: Lumileds 5050
- Input Volt: 100~277VAC or 198~440VAC
- IP & IK Rating : IP66 & IK10
- Bracket Materials: Iron or Aluminum die casting
- Function: Dali2.0 & DMX
- SPD: 10KV
- Beam Angle: 400W-800W 15° / 25° / 40° / 60° / 90°
- Beam Angle: 900W-1200W 12° / 22° / 40° / 60°
- Color Temp: 3000K~6000K
- 5 years warranty



100-277V



347-480V



Dimmable



L90B10
>100,000hrs



Adjust



-40~55°C



IK10



IP66



Aluminum die casting

Model	Watt	Efficiency #1	Lumen	Efficiency#2	Lumen	Bracket Materials	Weight
LSHM-400W(XXX)Round	400W	175lm/w±5%	70,000Lm	185lm/w±5%	74,000Lm	Iron or Aluminum die casting	14.9kg
LSHM-500W(XXX)Round	500W	170lm/w±5%	85,000Lm	180lm/w±5%	90,000Lm	Iron or Aluminum die casting	14.9kg
LSHM-600W(XXX)Round	600W	165lm/w±5%	99,000Lm	175lm/w±5%	105,000Lm	Iron or Aluminum die casting	14.9kg
LSHM-700W(XXX)Round	700W	170lm/w±5%	119,000Lm	180lm/w±5%	126,000Lm	Iron or Aluminum die casting	18.4kg
LSHM-800W(XXX)Round	800W	165lm/w±5%	132,000Lm	175lm/w±5%	140,000Lm	Iron or Aluminum die casting	18.4kg
LSHM-900W(XXX)Round	900W	165lm/w±5%	148,500Lm	175lm/w±5%	157,500Lm	Iron or Aluminum die casting	22.0kg
LSHM-1000W(XXX)Round	1000W	165lm/w±5%	165,000Lm	175lm/w±5%	175,000Lm	Iron or Aluminum die casting	22.0kg
LSHM-1000W(XXX)Round-B	1000W	175lm/w±5%	175,000Lm	185lm/w±5%	185,000Lm	Iron or Aluminum die casting	25.8kg
LSHM-1200W(XXX)Round	1200W	165lm/w±5%	198,000Lm	175lm/w±5%	210,000Lm	Iron or Aluminum die casting	25.8kg

Beam Angle

Symmetrical 400W-800W

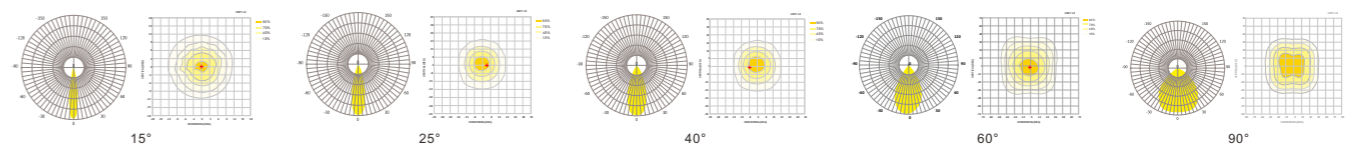

Symmetrical 900W-1200W

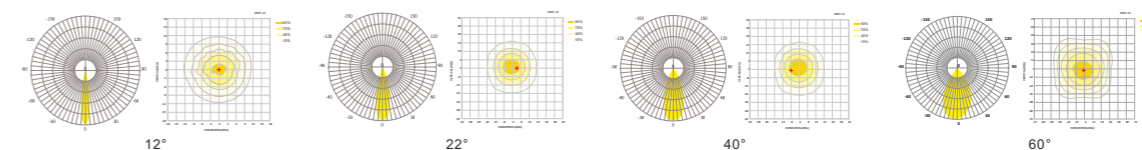

170 Lm/W

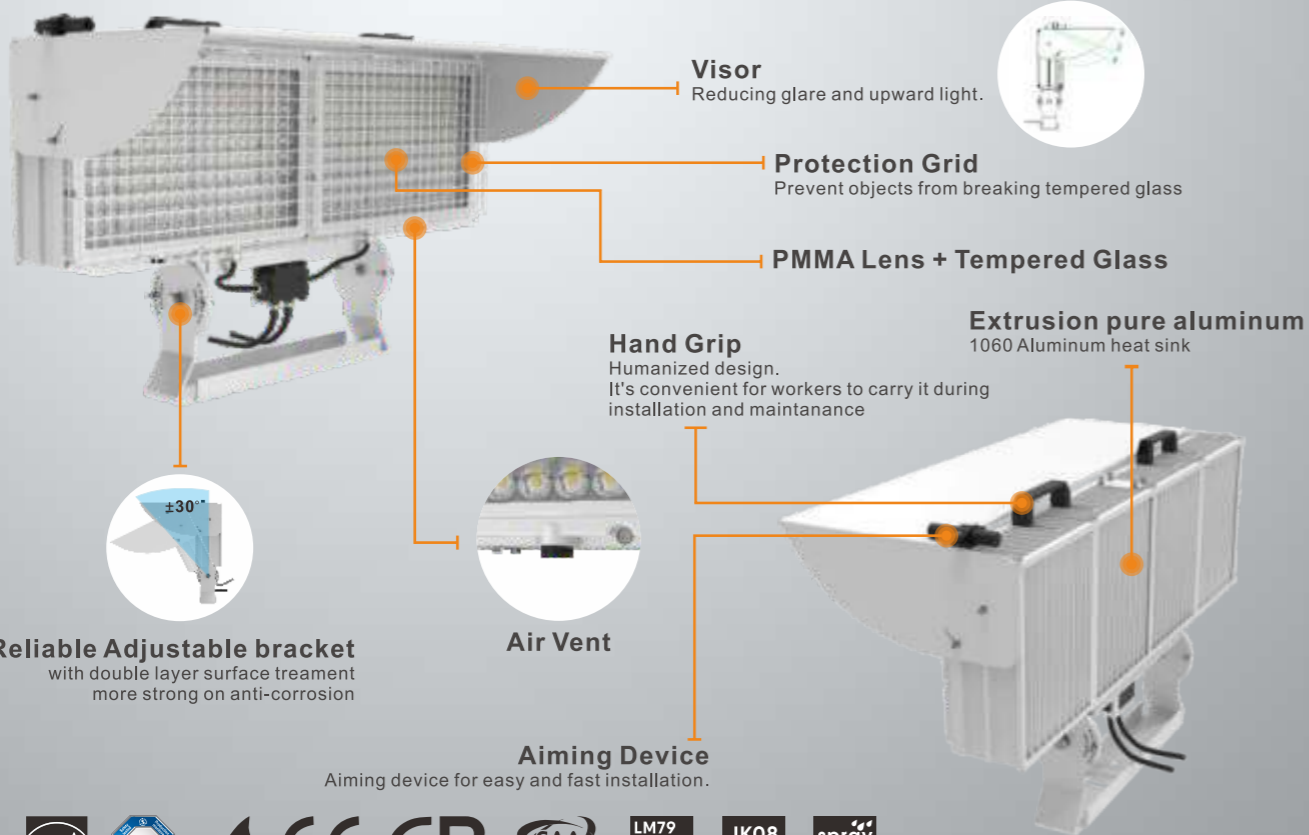
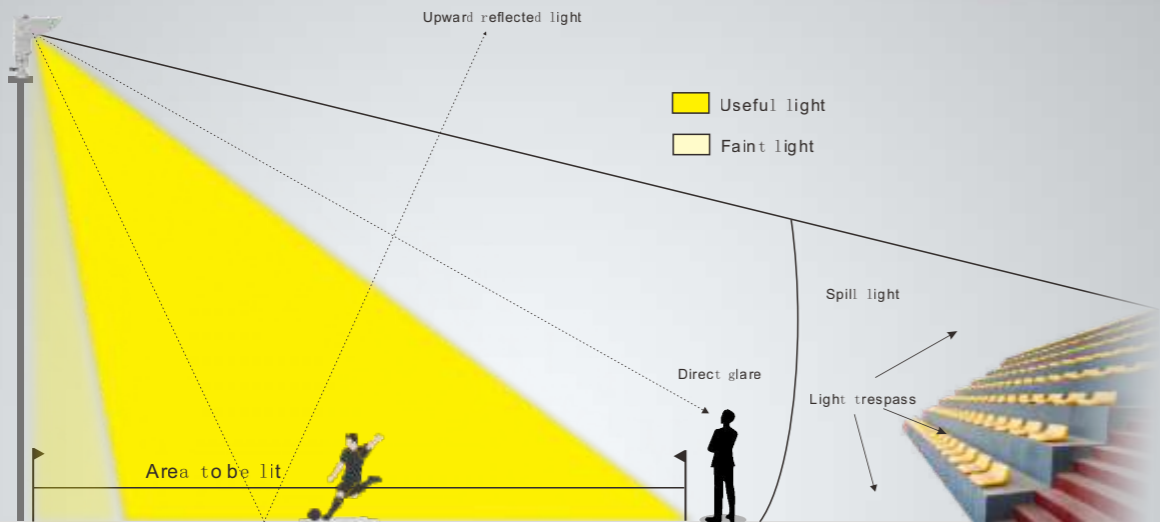

ALPHA

ANTI GLARED LED STADIUM FLOOD LIGHT 500W 600W 1000W 1200W

- Light Source: Lumileds 5050
- Input Volt: 176-305VAC
- IP & IK Rating : IP66 & IK08
- Dimmable: non-dimmable (Dimmable Optional)
- SPD: 10KV (20KV Optional)
- Beam Angle: P70 P45 30° 60° 90° T2M T3M
- Color Temp: 3000-6000K
- CRI: CRI>70 (CRI>80 optimal)
- GR: <40
- Anti glared Visor: Rotatable
- Reflector driver box: External Driver Box & Internal driver



Model	Watt	Lumen	Efficiency	CCT	Size	Driver	Weight
LSASL-500W-LV(XXK)	500W	70,000Lm	140Lm/w±3%	3000-6000K	470x382x525mm	Inventronics	16kg
		85,000Lm	170Lm/w±3%				
LSASL-600W-LV(XXK)	600W	81,000Lm	135Lm/w±3%	3000-6000K	470x382x525mm	Inventronics	16kg
		99,000Lm	165Lm/w±3%				
LSASL-1000W-LV(XXK)	1000W	140,000Lm	140Lm/w±3%	3000-6000K	920x382x545mm	Inventronics	28kg
		170,000Lm	170Lm/w±3%				
LSASL-1200W-LV(XXK)	1200W	162,000Lm	135Lm/w±3%	3000-6000K	920x382x545mm	Inventronics	28kg
		198,000Lm	165Lm/w±3%				

Beam Angle

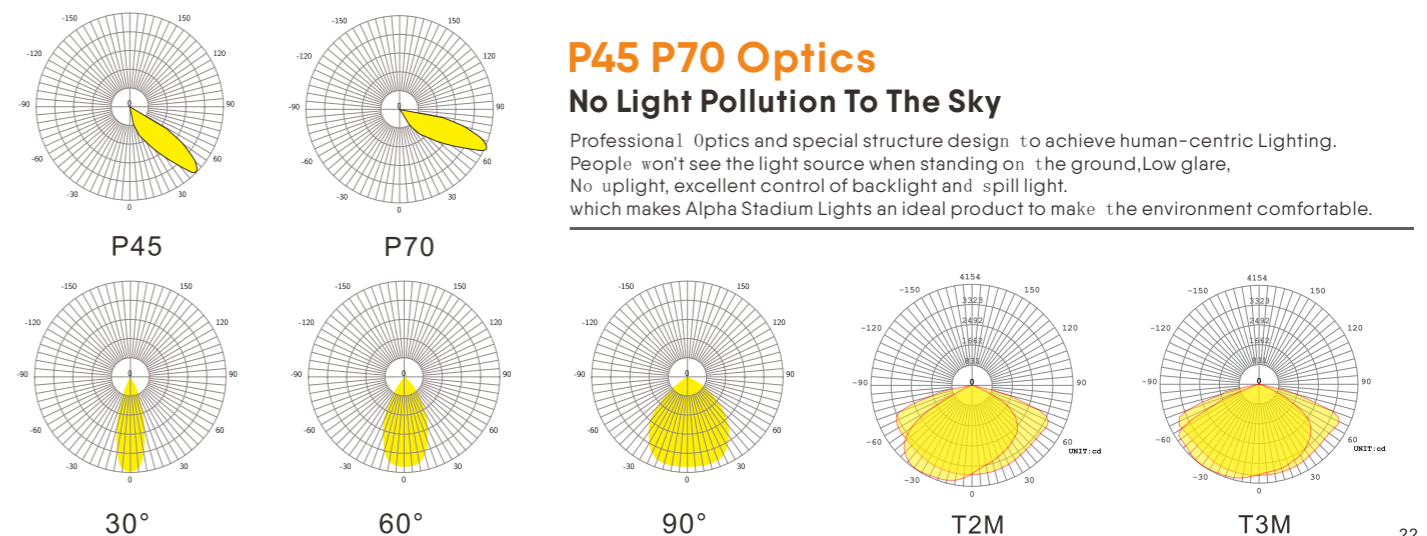

DRAGONFLY SERIES

LED SPORTS FLOODLIGHT HIGH MAST LIGHT



DRAGONFLY

LED SPORTS FLOODLIGHT HIGH MAST LIGHT

- Light Source: Lumileds 5050
- Input Volt: 100-277VAC
- modules are 360° rotatable, arm comes with scale plate.
- IK & IP Rating : Ik08 IP66
- Wind rating: 51.0-56.0m/s
- CCT: 3000-6500K
- 5 years warranty



360° Rotatable

100-277V

50,000H

Dimmable

-30-45°C

IK08

IP66

165 Lm/W

LIGHT WEIGHT FLODED FIN



► LIGHT WEIGHT

The advantage of aluminum fin heat dissipation is that the weight is reduced by about 30% to 40%. This is an advantage compared to traditional die-cast aluminum lamps for sports field lighting installations. To reduce the loading weight of the pole and to reduce the workload of the installer.



► FLODED FIN

This allows you to improve thermal performance while adding a minimal amount of weight. Folded Fin heatsinks use a continuous strip of aluminum sheet metal affixed to an aluminum base plate. The advantage of Folded Fin as opposed to extruded heatsinks is higher aspect ratios and thinner fins, thus increasing surface area and lowering thermal resistance. The stamping riveting process is not welded so that it make the aluminum fins fit more closely with the aluminum board, creating more surface touching area from led chips heat to the heat sink and contributing to faster heat dissipation.



Model	Watt	Lumen	Efficiency	Input Volt	Size	Driver	Weight
LSDHM-B240W-LV(XXK)	240W	39,600Lm	165lm/w±3%	100-277Vac	544x253x126.5mm	Meanwell	8.9kg
LSDHM-B300W-LV(XXK)	300W	46,500Lm	155lm/w±3%	100-277Vac		Meanwell	9.3kg
LSDHM-480W-LV(XXK)	480W	79,200Lm	165lm/w±3%	100-277Vac	685x553x173mm	Meanwell	16.2KG
LSDHM-600W-LV(XXK)	600W	93,000Lm	155lm/w±3%	100-277Vac		Meanwell	17KG
LSDHM-720W-LV(XXK)	720W	118,800Lm	165lm/w±3%	100-277Vac	685x853x172mm	Meanwell	22.8KG
LSDHM-900W-LV(XXK)	900W	139,500Lm	155lm/w±3%	100-277Vac		Meanwell	24KG
LSDHM-960W-LV(XXK)	960W	158,400Lm	165lm/w±3%	100-277Vac	999.7x923x221.2mm	Meanwell	30.4KG
LSDHM-1200W-LV(XXK)	1200W	186,000Lm	155lm/w±3%	100-277Vac		Meanwell	32kg
LSDHM-1440W-LV(XXK)	1440W	237,600Lm	165lm/w±3%	100-277Vac	1319.7x923x221.2mm	Meanwell	39.6kg
LSDHM-1800W-LV(XXK)	1800W	279,000Lm	155lm/w±3%	100-277Vac		Meanwell	42kg

Beam Angle

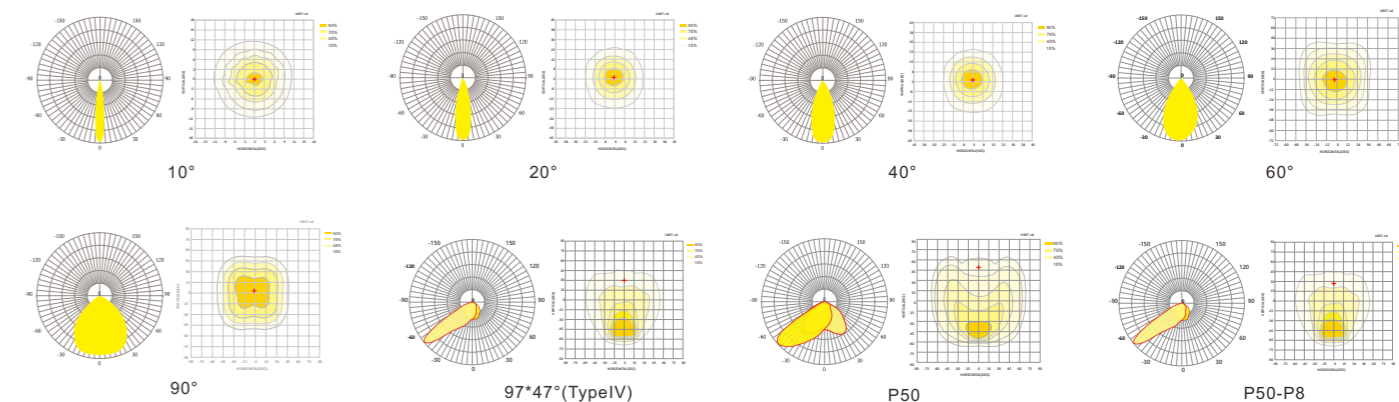



180 Lm/W

DRAGONFLY MAX

LED HIGH MAST LIGHTS

- Light Source: Lumileds 5050 / Osram 5050
- Input Volt: 100-277VAC / 347-480VAC
- IP & IK Rating : IP66 & IK10
- Dimmable: 1-10V
- SPD: 10KV / 20KV
- Beam Angle: Symmetrical 20° / 40° / 60°
- Beam Angle: Asymmetrical P50-L / P60-L
- Color Temp: 3000K 4000K 5000K 5700K 6000K
- 5 years warranty



Visor
Reducing glare and upward light



- Module fixing buckle**
The fixed buckle of the module is made of stainless steel and the left and right direction of the module can be adjusted by $\pm 45^\circ$
- Breathable Protective Air Vent Plug**
Each Module of comes with Waterproof Breathable Pressure Relief Vent Plug
- Tool-free for adjustment**
Knob fixing which is for tool-free adjustment of module angle $\pm 45^\circ$
- Pure aluminum heat sink**
pure aluminum body with strong anticorrosion performance and excellent heat dissipation ability.
- Driver box is separable**
The module is separated from the driver, and the driver box can be installed separately under the light pole for easy maintenance in the future days. Drivers and modules come with female/male connectors

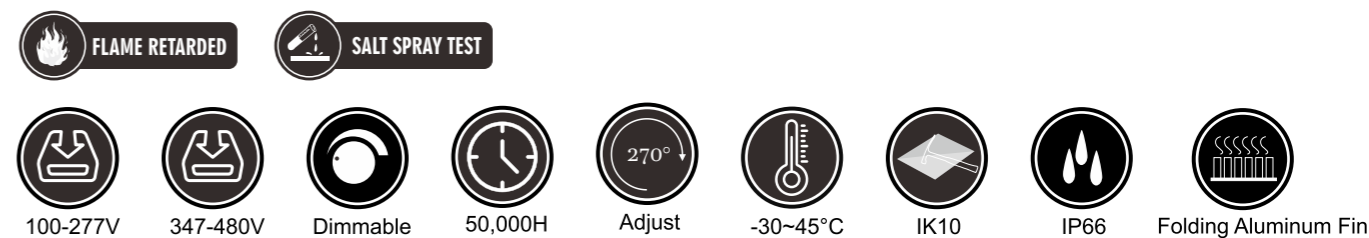

Model	Watt	Efficiency	Lumen	Driver	Size (L x W x H)	Weight
LSDHM-240W-LV(XXK)MAX	240W	180lm/w $\pm 3\%$	43,200Lm	Meanwell	381.5x300x120mm	4.2Kg
LSDHM-300W-LV(XXK)MAX	300W	170lm/w $\pm 3\%$	51,000Lm		381.5x300x120mm	4.2Kg
LSDHM-480W-LV(XXK)MAX	480W	180lm/w $\pm 3\%$	86,400Lm		420x787x540mm	14.5KG
LSDHM-600W-LV(XXK)MAX	600W	170lm/w $\pm 3\%$	102,000Lm		420x787x540mm	15KG
LSDHM-720W-LV(XXK)MAX	720W	180lm/w $\pm 3\%$	129,600Lm		420x960x754.5mm	19.5KG
LSDHM-900W-LV(XXK)MAX	900W	170lm/w $\pm 3\%$	153,000Lm		420x960x754.5mm	20.5KG
LSDHM-960W-LV(XXK)MAX	960W	180lm/w $\pm 3\%$	172,800Lm		818.5x788x555mm	25.5KG
LSDHM-1200W-LV(XXK)MAX	1200W	170lm/w $\pm 3\%$	204,000Lm		818.5x788x555mm	26.5KG
LSDHM-1440W-LV(XXK)MAX	1440W	180lm/w $\pm 3\%$	259,200Lm		818.5x962x785mm	34.5KG
LSDHM-1800W-LV(XXK)MAX	1800W	170lm/w $\pm 3\%$	306,000Lm		818.5x962x785mm	36.5KG

Model	Watt	Efficiency	Lumen	Driver	Size (L x W x H)	Weight
LSDHM-200W-LV(XXK)MAX	200W	200lm/w $\pm 3\%$	40,000Lm	Meanwell	381.5x300x120mm	4.2Kg
LSDHM-400W-LV(XXK)MAX	400W	200lm/w $\pm 3\%$	80,000Lm		420x787x540mm	14.5KG
LSDHM-600W-LV(XXK)MAX-C	600W	200lm/w $\pm 3\%$	120,000Lm		420x960x754.5mm	19.5KG
LSDHM-800W-LV(XXK)MAX	800W	200lm/w $\pm 3\%$	160,000Lm		818.5x788x555mm	25.5KG
LSDHM-1200W-LV(XXK)MAX-C	1200W	200lm/w $\pm 3\%$	240,000Lm		818.5x962x785mm	34.5KG

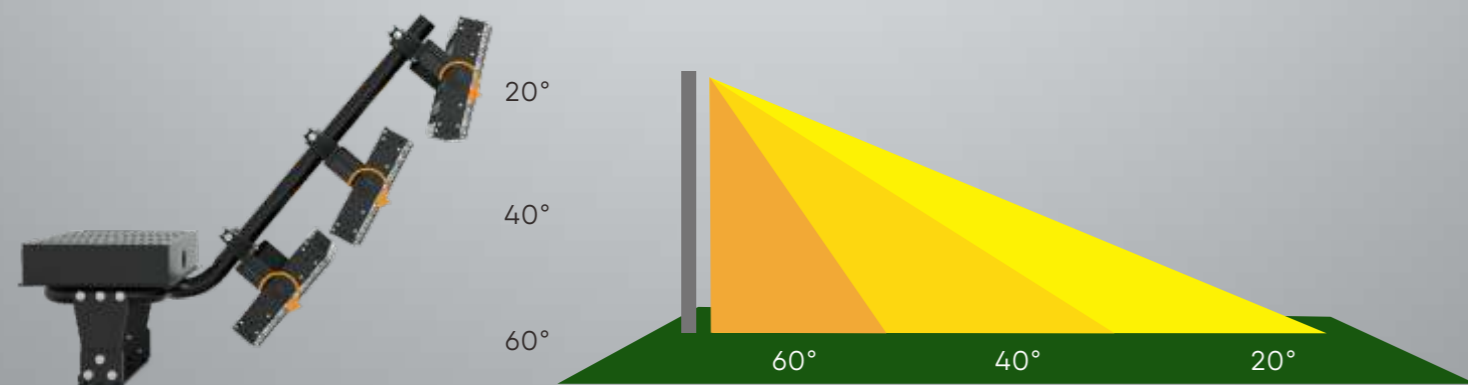

Beam Angle

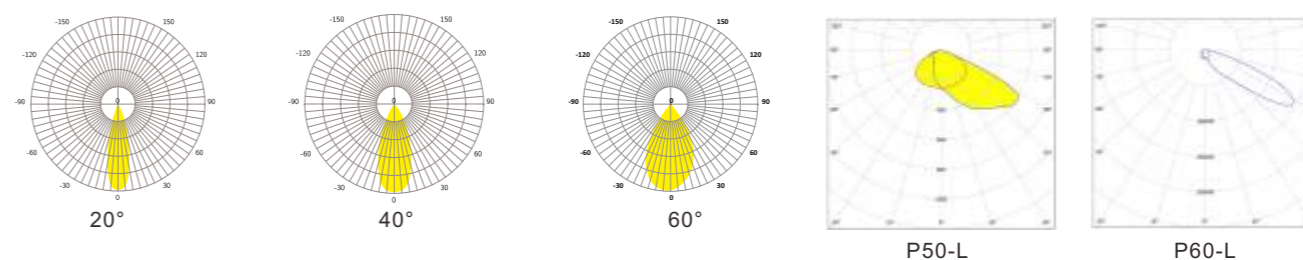



TRANSFORMES SERIES

LED HIGH MAST LIGHT 400W-1440W



TRANSFORMER

175Lm/W

LED HIGH MAST LIGHTS

- Light Source: Lumileds 5050
- Input Volt: 100-277VAC
- IP & IK Rating : IP66 & IK10
- Dimmable: 1-10V / 0-10V (Optional)
- SPD: 10KV / 20KV (Optional)
- Beam Angle: Symmetrical 10° / 20° / 40° / 60° / 90° / 40x100°
- Beam Angle: Asymmetrical P50 / P65 / P70
- Color Temp: 3000K~6500K
- Modules: 360° Rotatable
- 5 years warranty



LIGHT WEIGHT FLODED FIN



- 100-277V
- 347-480V
- Dimmable
- 50,000H
- Module Rotatable -30~45°C
- IK10
- IP66
- Folding Aluminum Fin

- All Applications**
 - Uniformity and light quality
 - Light pollution and spillage
 - Controls
- Soccer, Lacrosse, Mixed Use**
 - Pole location
 - Pole quantity
 - Number of fixtures per pole
- Baseball, Softball**
 - High levels of illumination
 - Lighted from all sides
 - Reducing glare
- Basketball, Tennis**
 - Floodlight, or area-style fixtures
 - Court configuration (grouping)
 - Court access
- Harbors, Wharfs**
 - Pole location (primarily sidelines)
 - Pole quantity
 - Number of fixtures per pole

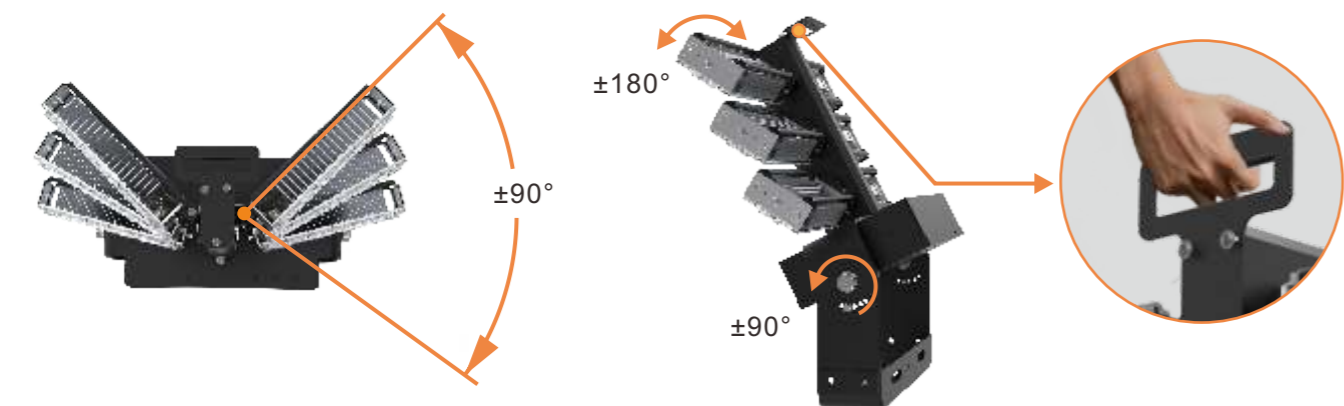

Model	Watt	Efficiency	Lumen	CCT	Driver	Weight
LSTHM-B400W-LV(XXK)	400W	160Lm/w±3%	64,000Lm	3000K-6000K	Meanwell	23.0KG
		175Lm/w±3%	70,000Lm			
LSTHM-B480W-LV(XXK)	480W	155Lm/w±3%	74,400Lm	3000K-6000K	Meanwell	23.0KG
		170Lm/w±3%	81,600Lm			
LSTHM-B600W-LV(XXK)	600W	160Lm/w±3%	96,000Lm	3000K-6000K	Meanwell	26.5KG
		175Lm/w±3%	105,000Lm			
LSTHM-B720W-LV(XXK)	720W	155Lm/w±3%	111,600Lm	3000K-6000K	Meanwell	26.5KG
		170Lm/w±3%	122,400Lm			
LSTHM-B800W-LV(XXK)	800W	160Lm/w±3%	128,000Lm	3000K-6000K	Meanwell	31.5KG
		175Lm/w±3%	140,000Lm			
LSTHM-B960W-LV(XXK)	960W	155Lm/w±3%	148,800Lm	3000K-6000K	Meanwell	31.5KG
		170Lm/w±3%	163,200Lm			
LSTHM-B1000W-LV(XXK)	1000W	160Lm/w±3%	160,000Lm	3000K-6000K	Meanwell	37.0KG
		175Lm/w±3%	175,000Lm			
LSTHM-B1200W-LV(XXK)	1200W	155Lm/w±3%	186,000Lm	3000K-6000K	Meanwell	37.0KG
		170Lm/w±3%	204,000Lm			
LSTHM-B1440W-LV(XXK)	1440W	160Lm/w±3%	230,400Lm	3000K-6000K	Meanwell	43.0KG
		170Lm/w±3%	244,800Lm			





ULTRA SERIES

LED HIGH MAST LIGHT 480W-1800W

190 Lm/W

ULTRA

LED HIGH MAST LIGHTS
400W ~ 1800W

- Light Source: Luminileds 5050
- Input Volt: 100-277VAC / 347-480VAC
- IP Rating IK Rating : IP66 & IK08
- Beam Angle: 10° 30° 60° 90° 137*80° 146*83°
- Color Temp: 3000K 4000K 5000K 5700K 6000K
- With Tempered glass
- 5 years warranty



ULTRA SERIES LED SPORTS LIGHT

The Ultra series of LED high-mast lights are sturdy and durable with integrated aluminum alloy die-casting honeycomb heat dissipation design. And the surface has adopted black sand powder spray treatment corrosion resistance oxidation resistance, and salt spray resistance. What's more, it uses the stainless steel bracket and Silicone gaskets and the screws are made of AISI 304 stainless steel.



HIGH LUMINOUS EFFICIENCY

The Ultra series led high-pole floodlights are aimed at the application needs of large area lighting. The Ultra series flood lights can be expanded from 480W to 1800W, with a luminous effect of up to 190LM/W and it can be used in various beam angle degree for the different area lighting requirements to achieve better lighting effects.

TUV CE CB SAA RoHS IK10 IP66 spray test LM79 LM80 TM21



100-277VAC
347-480VAC



50,000H



Modules



-30~45°C



IK10



IP66

Model	Watt	Efficiency	Lumen	Driver	Size (LxWxH)	Weight
LSHM-400W-LV(XXX)Ultra	400W	180lm/w±3%	72,000Lm	Inventronics/Sosen	531x377x129mm	15Kg
LSHM-480W-LV(XXX)Ultra	480W	190LM/W±3%	912,000Lm	Inventronics/Sosen	637x462x134mm	15Kg
LSHM-600W-LV(XXX)Ultra	600W	180LM/W±3%	108,000Lm	Inventronics/Sosen	637x462x134mm	15Kg
LSHM-800W-LV(XXX)Ultra	800W	180LM/W±3%	144,000Lm	Inventronics/Sosen	763x573x151.5mm	32Kg
LSHM-960W-LV(XXX)Ultra	960W	190LM/W±3%	182,400Lm	Inventronics/Sosen	869x678x152mm	32Kg
LSHM-1200W-LV(XXX)Ultra	1200W	180LM/W±3%	216,000Lm	Inventronics/Sosen	869x678x152mm	48Kg
LSHM-1440W-LV(XXX)Ultra	1440W	190LM/W±3%	273,600Lm	Inventronics/Sosen	1267x678x152mm	48Kg
LSHM-1800W-LV(XXX)Ultra	1800W	180LM/W±3%	324,000Lm	Inventronics/Sosen	1267x678x152mm	48Kg

Beam Angle

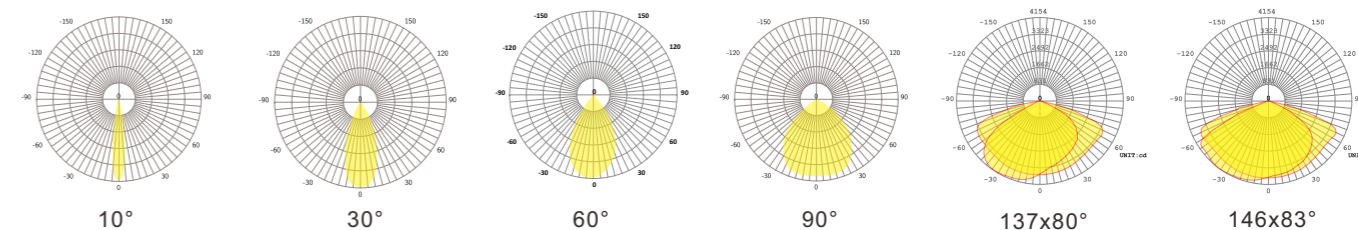



LED CONVEYOR LIGHT

EASY TO INSTALL, HIGHLY RELIABLE CONVEYOR LIGHT

- As high efficiency up to 165Lm/w which means less power and lower bill of electricity
- It's available with a solid-state integral emergency module.it performs constant operational readiness tests,ensuring reliable emergency lighting will be available when needed.
- Operating temp is -30 ~ 40°C for Emergency version
- 5 years warranty

165Lm/W

TECHNICAL PARAMETERS

Light Source	Lumileds 3030
IK & IP Rating	IK08 / IP66
Input Voltage	100-277VAC
CCT	3000K~6000K
Efficiency	165Lm/W
Operating Temperature	-30 ~ 50°C
Lifetime	50,000+ hours
Arm Dia	32~42mm

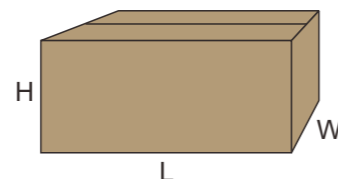
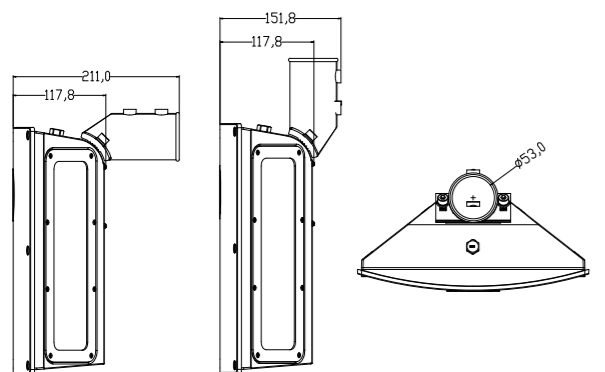
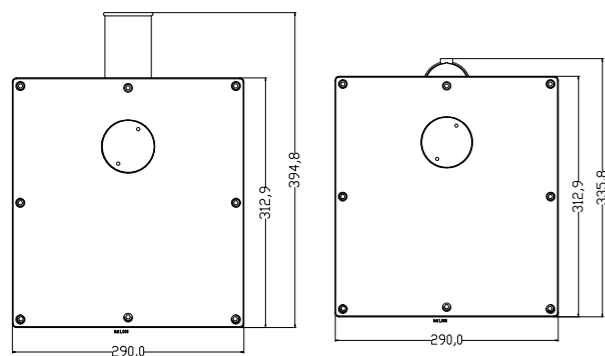

L	42cm
W	38cm
H	22cm
G.W.	5.2Kg
Box Qty	1PC

SPECIFICATIONS INFORMATION

Model	Watt	Input Voltage	Efficiency	Lumen	Beam Angles	SPD (Optional)	Driver
LSCVL-30W(XXK)	30W	100-277VAC	165Lm/w	4950Lm	Dedicated Optic	10KV/20KV	Moso Driver
LSCVL-36W(XXK)	36W	100-277VAC	162Lm/w	5832Lm	Dedicated Optic	10KV/20KV	Moso Driver
LSCVL-42W(XXK)	42W	100-277VAC	158Lm/w	6636Lm	Dedicated Optic	10KV/20KV	Moso Driver
LSCVL-62W(XXK)	62W	100-277VAC	155Lm/w	9610Lm	Dedicated Optic	10KV/20KV	Moso Driver
LSCVL-70W(XXK)	70W	100-277VAC	150Lm/w	10500Lm	Dedicated Optic	10KV/20KV	Moso Driver

*3000K: The luminous flux is 15% less compared to 5000K

LED CONVEYOR LIGHT

30W 36W 42W 62W 70W

It is designed to provide the most energy-efficient way of illuminating industrial conveyors and walkways, capable of delivering the required minimum of 40 lux with an average of 80 lux when spaced as far as 15m apart with a typical installation height of 3.0m Raising the bar of performance and efficiency for industrial conveyor and walkway lighting

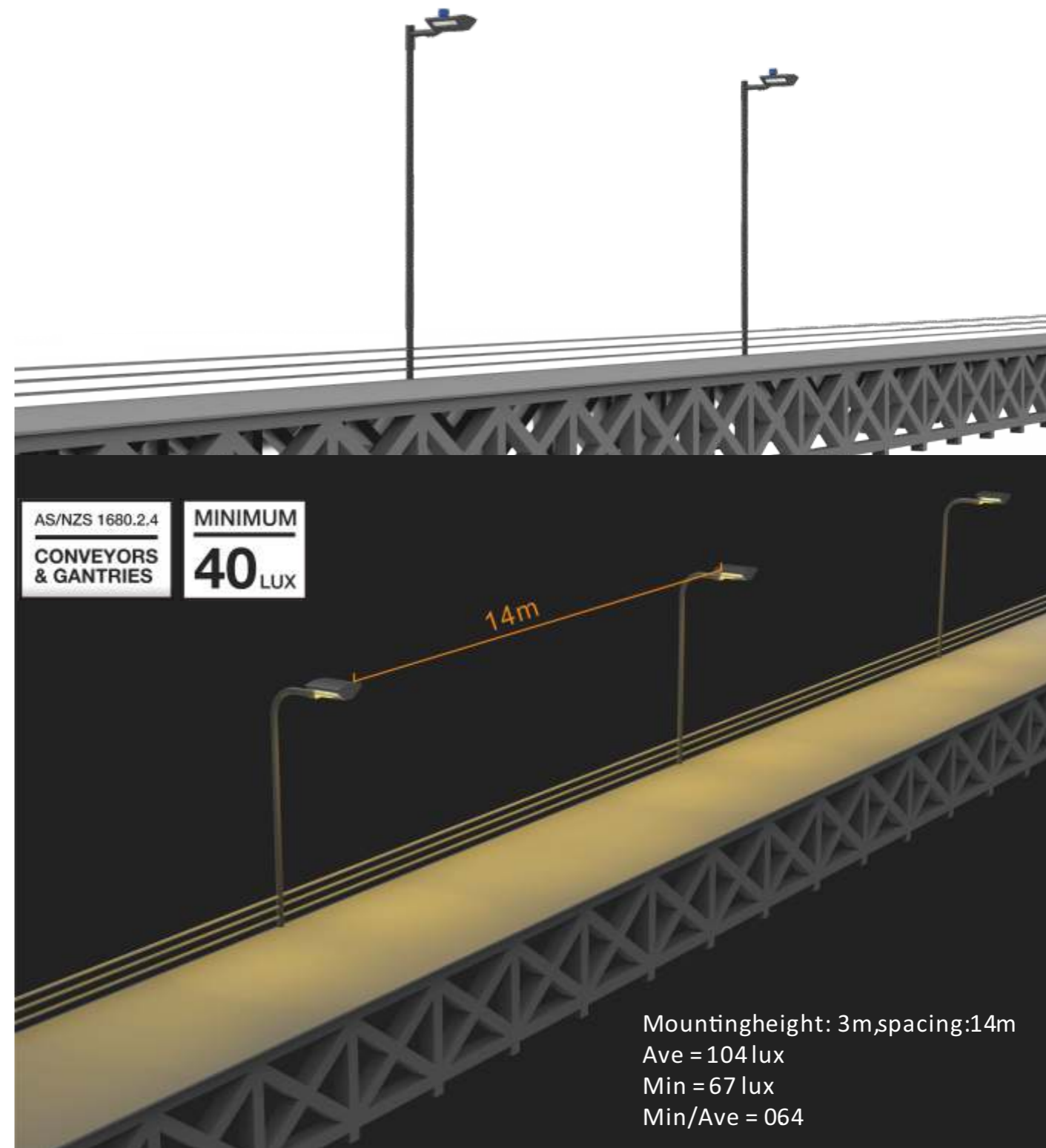



SKYSCRAPER

Urban Lighting LED Post Top Light
Tempered Outdoor Street Landscape Light Fixtures

The aesthetics of the city is inseparable from lighting, Skyscraper satisfied the trend of urban differentiation with smooth curvature, which effectively prevents the accumulation of dust and leaves, not only creates a neat atmosphere, but also provides excellent heat dissipation. In general, the traditional industrial lighting design is not obvious enough, and through continuous optimization, the overall display is more modern.

170 Lm/W

TECHNICAL PARAMETERS

Light Source	Lumileds 2835
IK & IP Rating	IK08 / IP66
Input Voltage	100-277VAC
CCT	3000K~6000K
Efficiency	140~170Lm/W
Beam Angle	T2 T3 T4 T5(140x140°)
Lifetime	50,000+ hours
Arm Dia	60-80mm

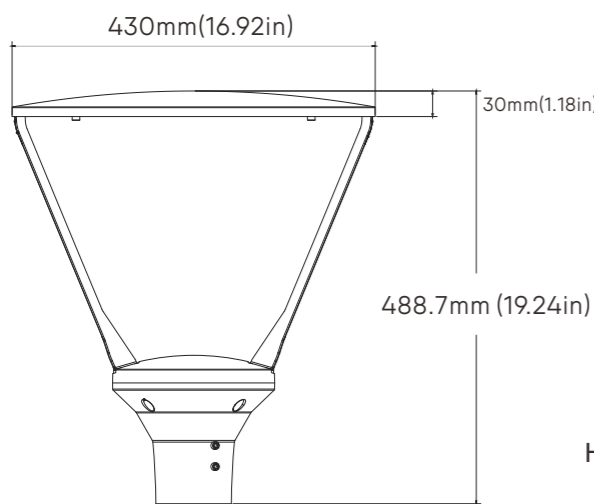

L	54cm
W	48cm
H	30cm
G.W.	7.5Kg
Box Qty	1PC

SPECIFICATIONS INFORMATION

Model	Watt	Input Voltage	Efficiency	Lumen	Beam Angles	SPD (Optional)	Driver
LSPT-30W(XXK)Plus	30W	100-277VAC	170Lm/w	5100Lm	T2 T3 T4 T5(140x140°)	10KV/20KV	Lifud/Moso/Sosen/Becky
LSPT-40W(XXK)Plus	40W	100-277VAC	165Lm/w	6600Lm	T2 T3 T4 T5(140x140°)	10KV/20KV	Lifud/Moso/Sosen/Becky
LSPT-50W(XXK)Plus	50W	100-277VAC	160Lm/w	8000Lm	T2 T3 T4 T5(140x140°)	10KV/20KV	Lifud/Moso/Sosen/Becky
LSPT-60W(XXK)Plus	60W	100-277VAC	160Lm/w	9600Lm	T2 T3 T4 T5(140x140°)	10KV/20KV	Lifud/Moso/Sosen/Becky
LSPT-80W(XXK)Plus	80W	100-277VAC	155Lm/w	12400Lm	T2 T3 T4 T5(140x140°)	10KV/20KV	Lifud/Moso/Sosen/Becky
LSPT-100W(XXK)Plus	100W	100-277VAC	150Lm/w	15000Lm	T2 T3 T4 T5(140x140°)	10KV/20KV	Lifud/Moso/Sosen/Becky
LSPT-120W(XXK)Plus	120W	100-277VAC	140Lm/w	16800Lm	T2 T3 T4 T5(140x140°)	10KV/20KV	Lifud/Moso/Sosen/Becky
LSPT-150W(XXK)Plus	150W	100-277VAC	140Lm/w	21000Lm	T2 T3 T4 T5(140x140°)	10KV/20KV	Lifud/Moso/Sosen/Becky

SKYSCRAPER

LED POST TOP LIGHT FIXTURES 30W-150W

Led Post Top Pole Lights LED Circular Area Light 30W-150W, Outdoor Lamp Top Pathway Pole Light Fixture for School Street Garden Yard Commercial Area Light, An IP66 Rating for Water-Resistance Our LED post-top/garden light being IP66 & IK08 rated is protected against dust and moisture (or water from a nozzle), making the lighting fixture suitable to damp locations.

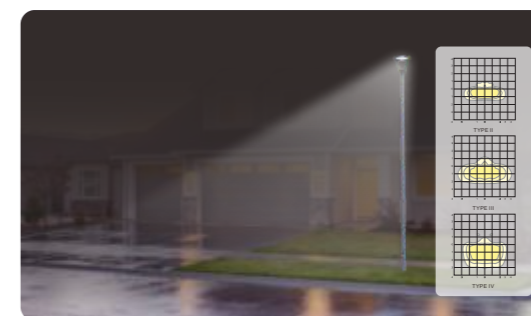

Single (1)

Die cast aluminum fitter base secured to pole with two stainless steel, Allen head set screws.

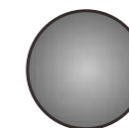

Double (2)

Double luminaire mounting arm secured to pole with four stainless steel, Allen head set screws.

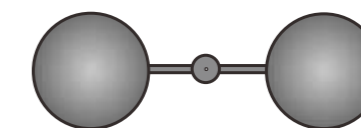

Wall (W)

Double wall mount arm secured to wall with screws.

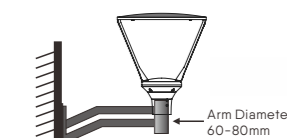
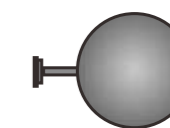

Single post top 10-18 ft. Mounting heights (Spider / Cantilever mount only)

Recommended Optical Angles

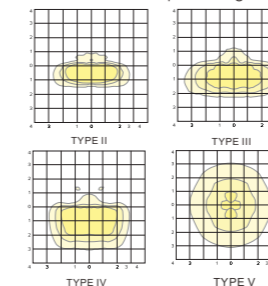

Twin mount arm 18-22 ft. Mounting heights (Spider / Cantilever mount only)

Recommended Optical Angles

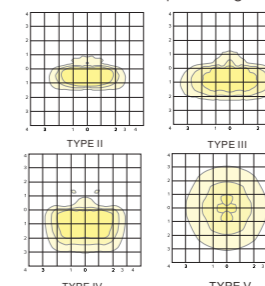

Wall mount arm 8-10 ft. Mounting heights (Spider / Cantilever mount only)

Recommended Optical Angles

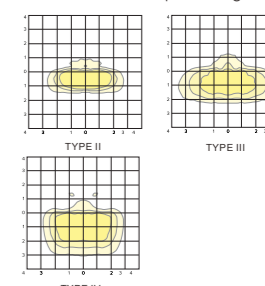



170 Lm/W

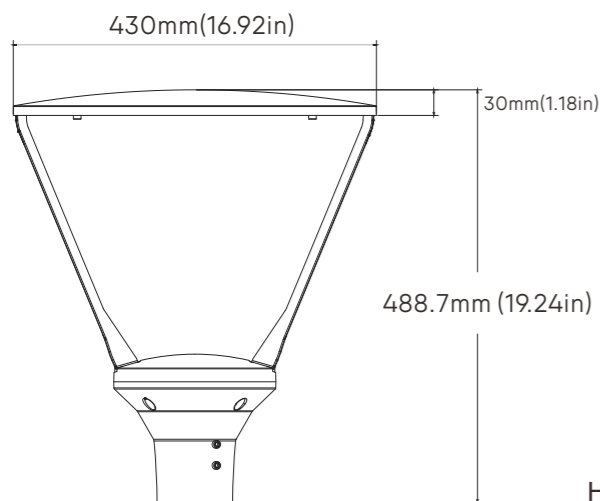

Wattage And CCT Adjustable

SKYSCRAPER

Urban Lighting LED Post Top Light
Tempered Outdoor Street Landscape Light Fixtures

The aesthetics of the city is inseparable from lighting, Skyscraper satisfied the trend of urban differentiation with smooth curvature, which effectively prevents the accumulation of dust and leaves, not only creates a neat atmosphere, but also provides excellent heat dissipation. In general, the traditional industrial lighting design is not obvious enough, and through continuous optimization, the overall display is more modern.

TECHNICAL PARAMETERS

Light Source	Lumileds 2835
IK & IP Rating	IK08 / IP66
Input Voltage	100-277VAC
CCT Adjustable	3000K - 4000K - 5000K
Beam Angle	T2 T3 T4 T5(140x140°)
Efficiency	140~170Lm/W
Lifetime	50,000+ hours
Arm Dia	60-80mm



L	54cm
W	48cm
H	30cm
G.W.	7.5Kg
Box Qty	1PC

SPECIFICATIONS INFORMATION

Model	Wattage Adjustable	CCT Adjustable	Efficiency	Lumen	SPD (Optional)	Driver
LSPT-50W(XXK)Plus	30W	3000K - 4000K - 5000K	170Lm/w	5,100Lm	10KV/20KV	Lifud/Moso/Sosen/Becky
	40W	3000K - 4000K - 5000K	165Lm/w	6,800Lm	10KV/20KV	Lifud/Moso/Sosen/Becky
	50W	3000K - 4000K - 5000K	160Lm/w	8,000Lm	10KV/20KV	Lifud/Moso/Sosen/Becky
LSPT-100W(XXK)Plus	60W	3000K - 4000K - 5000K	160Lm/w	9,600Lm	10KV/20KV	Lifud/Moso/Sosen/Becky
	80W	3000K - 4000K - 5000K	155Lm/w	12,400Lm	10KV/20KV	Lifud/Moso/Sosen/Becky
	100W	3000K - 4000K - 5000K	150Lm/w	15,000Lm	10KV/20KV	Lifud/Moso/Sosen/Becky
LSPT-150W(XXK)Plus	100W	3000K - 4000K - 5000K	150Lm/w	15,000Lm	10KV/20KV	Lifud/Moso/Sosen/Becky
	120W	3000K - 4000K - 5000K	140Lm/w	16,800Lm	10KV/20KV	Lifud/Moso/Sosen/Becky
	150W	3000K - 4000K - 5000K	140Lm/w	21,000Lm	10KV/20KV	Lifud/Moso/Sosen/Becky

1)Alone only Wattage Adjustable can be configured optical lens 2)Simultaneous Wattage And CCT Adjustable can not be configured with optical lens

SKYSCRAPER

LED POST TOP LIGHT FIXTURES 30W-150W

Led Post Top Pole Lights LED Circular Area Light 30W-150W,Outdoor Lamp Top Pathway Pole Light Fixture for School Street Garden Yard Commercial Area Light,An IP66 Rating for Water-Resistance Our LED post-top/garden light being IP66 & IK08 rated is protected against dust and moisture (or water from a nozzle), making the lighting fixture suitable to damp locations.

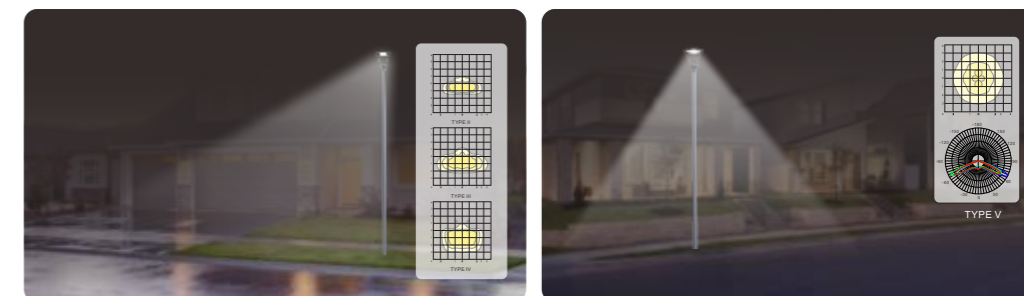

Single (1)
Die cast aluminum fitter base secured to pole with two stainless steel, Allen head set screws.

Double (2)
Double luminaire mounting arm secured to pole with four stainless steel, Allen head set screws.

Wall (W)
Double wall mount arm secured to wall with set screws.

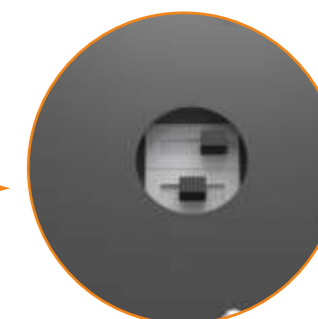
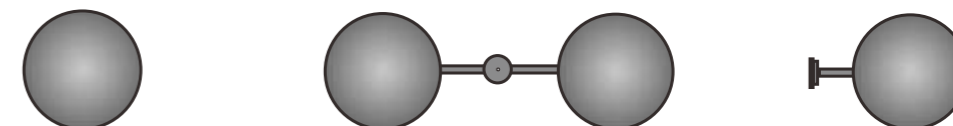

Wattage Switchable
30W / 40W / 50W
60W / 80W / 100W
100W / 120W / 150W

3 CCT Switchable
3000K-4000K-5000K



170 Lm/W

SKYLINE

Urban Lighting LED Post Top Light
Tempered Outdoor Street Landscape Light Fixtures

The aesthetics of the city is inseparable from lighting, Skyline satisfied the trend of urban differentiation with smooth curvature, which effectively prevents the accumulation of dust and leaves, not only creates a neat atmosphere, but also provides excellent heat dissipation. In general, the traditional industrial lighting design is not obvious enough, and through continuous optimization, the overall display is more modern.

TECHNICAL PARAMETERS

Light Source	Lumileds 2835
IK & IP Rating	IK08 / IP66
Input Voltage	100-277VAC
CCT	3000K~6000K
Efficiency	140~170Lm/W
Beam Angle	T2 T3 T4 T5(140x140°)
Lifetime	50,000+ hours
Arm Dia	60-80mm



L	54cm
W	48cm
H	20
G.W.	8.0Kg
Box Qty	1PC

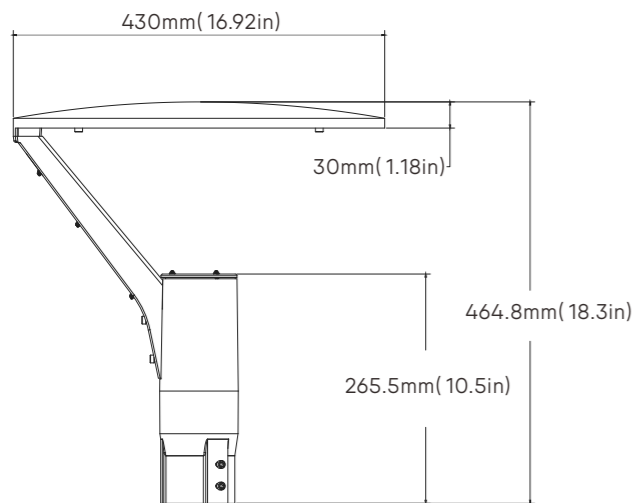

SPECIFICATIONS INFORMATION

Model	Watt	Input Voltage	Efficiency	Lumen	Beam Angles	SPD (Optional)	Driver
LSPT-30W(XXK)	30W	100-277VAC	170Lm/w	5100Lm	T2 T3 T4 T5(140x140°)	10KV/20KV	Lifud/Moso/Sosen/Becky
LSPT-40W(XXK)	40W	100-277VAC	165Lm/w	6600Lm	T2 T3 T4 T5(140x140°)	10KV/20KV	Lifud/Moso/Sosen/Becky
LSPT-50W(XXK)	50W	100-277VAC	160Lm/w	8000Lm	T2 T3 T4 T5(140x140°)	10KV/20KV	Lifud/Moso/Sosen/Becky
LSPT-60W(XXK)	60W	100-277VAC	160Lm/w	9600Lm	T2 T3 T4 T5(140x140°)	10KV/20KV	Lifud/Moso/Sosen/Becky
LSPT-80W(XXK)	80W	100-277VAC	155Lm/w	12400Lm	T2 T3 T4 T5(140x140°)	10KV/20KV	Lifud/Moso/Sosen/Becky
LSPT-100W(XXK)	100W	100-277VAC	150Lm/w	15000Lm	T2 T3 T4 T5(140x140°)	10KV/20KV	Lifud/Moso/Sosen/Becky
LSPT-120W(XXK)	120W	100-277VAC	140Lm/w	16800Lm	T2 T3 T4 T5(140x140°)	10KV/20KV	Lifud/Moso/Sosen/Becky
LSPT-150W(XXK)	150W	100-277VAC	140Lm/w	21000Lm	T2 T3 T4 T5(140x140°)	10KV/20KV	Lifud/Moso/Sosen/Becky

SKYLINE

LED POST TOP LIGHT FIXTURES 30W-150W

Led Post Top Pole Lights LED Circular Area Light 30W-150W, Outdoor Lamp Top Pathway Pole Light Fixture for School Street Garden Yard Commercial Area Light, An IP66 Rating for Water-Resistance Our LED post-top/garden light being IP66 & IK08 rated is protected against dust and moisture (or water from a nozzle), making the lighting fixture suitable to damp locations.



Single (1)

Die cast aluminum fitter base secured to pole with two stainless steel, Allen head set screws.

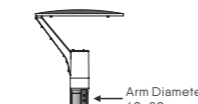
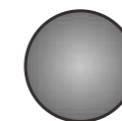

Single post top
10-18 ft. Mounting heights
(Spider / Cantilever mount only)

Recommended Optical Angles

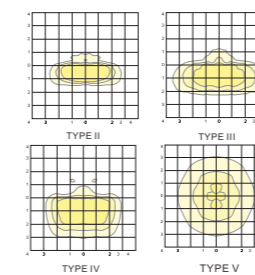

Double (2)

Double luminaire mounting arm secured to pole with four stainless steel, Allen head set screws.

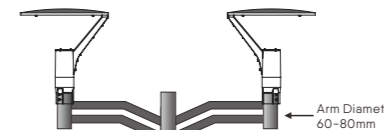
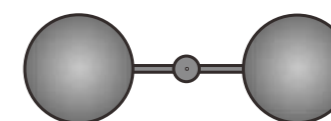

Twin mount arm
18-22 ft. Mounting heights
(Spider / Cantilever mount only)

Recommended Optical Angles

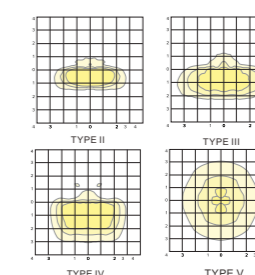

Wall (W)

Double wall mount arm secured to wall with

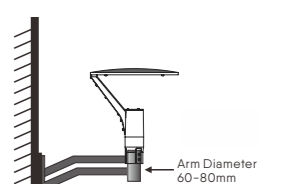
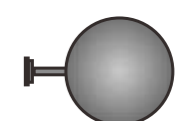

Wall mount arm
8-10 ft. Mounting heights
(Spider / Cantilever mount only)

Recommended Optical Angles

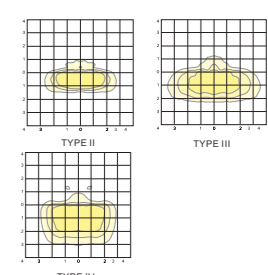



170 Lm/W

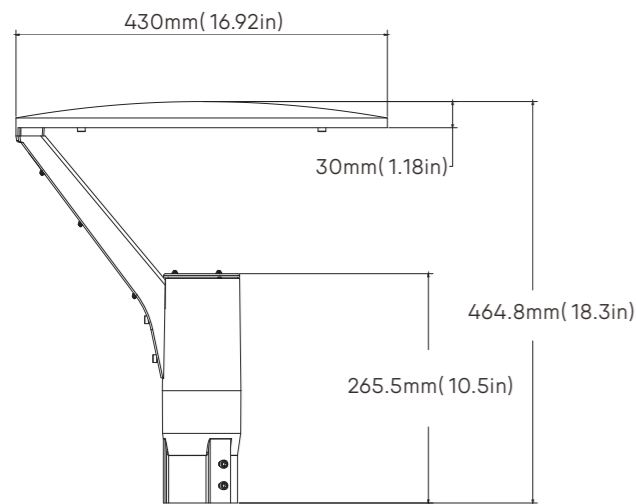

Wattage And CCT Adjustable

SKYLINE

Urban Lighting LED Post Top Light
Tempered Outdoor Street Landscape Light Fixtures

The aesthetics of the city is inseparable from lighting, Skyline satisfied the trend of urban differentiation with smooth curvature, which effectively prevents the accumulation of dust and leaves, not only creates a neat atmosphere, but also provides excellent heat dissipation. In general, the traditional industrial lighting design is not obvious enough, and through continuous optimization, the overall display is more modern.

TECHNICAL PARAMETERS

Light Source	Lumileds 2835
IK & IP Rating	IK08 / IP66
Input Voltage	100-277VAC
CCT Adjustable	3000K - 4000K - 5000K
Beam Angle	T2 T3 T4 T5(140x140°)
Efficiency	140~170Lm/W
Lifetime	50,000+ hours
Arm Dia	60-80mm



100-277VAC	50,000H	IP66	IK08	-40~55°C
L	54cm			
W	48cm			
H	20			
G.W.	8.0Kg			
Box Qty	1PC			

SPECIFICATIONS INFORMATION

Model	Wattage Adjustable	CCT Adjustable	Efficiency	Lumen	SPD (Optional)	Driver
LSPT-50W(XXX)	30W	3000K - 4000K - 5000K	170Lm/w	5,100Lm	10KV/20KV	Lifud/Moso/Sosen/Becky
	40W	3000K - 4000K - 5000K	165Lm/w	6,800Lm	10KV/20KV	Lifud/Moso/Sosen/Becky
	50W	3000K - 4000K - 5000K	160Lm/w	8,000Lm	10KV/20KV	Lifud/Moso/Sosen/Becky
LSPT-100W(XXX)	60W	3000K - 4000K - 5000K	160Lm/w	9,600Lm	10KV/20KV	Lifud/Moso/Sosen/Becky
	80W	3000K - 4000K - 5000K	155Lm/w	12,400Lm	10KV/20KV	Lifud/Moso/Sosen/Becky
	100W	3000K - 4000K - 5000K	150Lm/w	15,000Lm	10KV/20KV	Lifud/Moso/Sosen/Becky
LSPT-150W(XXX)	100W	3000K - 4000K - 5000K	150Lm/w	15,000Lm	10KV/20KV	Lifud/Moso/Sosen/Becky
	120W	3000K - 4000K - 5000K	140Lm/w	16,800Lm	10KV/20KV	Lifud/Moso/Sosen/Becky
	150W	3000K - 4000K - 5000K	140Lm/w	21,000Lm	10KV/20KV	Lifud/Moso/Sosen/Becky

1)Alone only Wattage Adjustable can be configured optical lens 2)Simultaneous Wattage And CCT Adjustable can not be configured with optical lens

SKYLINE

LED POST TOP LIGHT FIXTURES 30W-150W

Led Post Top Pole Lights LED Circular Area Light 30W-150W,Outdoor Lamp Top Pathway Pole Light Fixture for School Street Garden Yard Commercial Area Light,An IP66 Rating for Water-Resistance Our LED post-top/garden light being IP66 & IK08 rated is protected against dust and moisture (or water from a nozzle), making the lighting fixture suitable to damp locations.



Single (1) Die cast aluminum fitter base secured to pole with two stainless steel, Allen head set screws.
Double (2) Double luminaire mounting arm secured to pole with four stainless steel, Allen head set screws.
Wall (W) Double wall mount arm secured to wall with

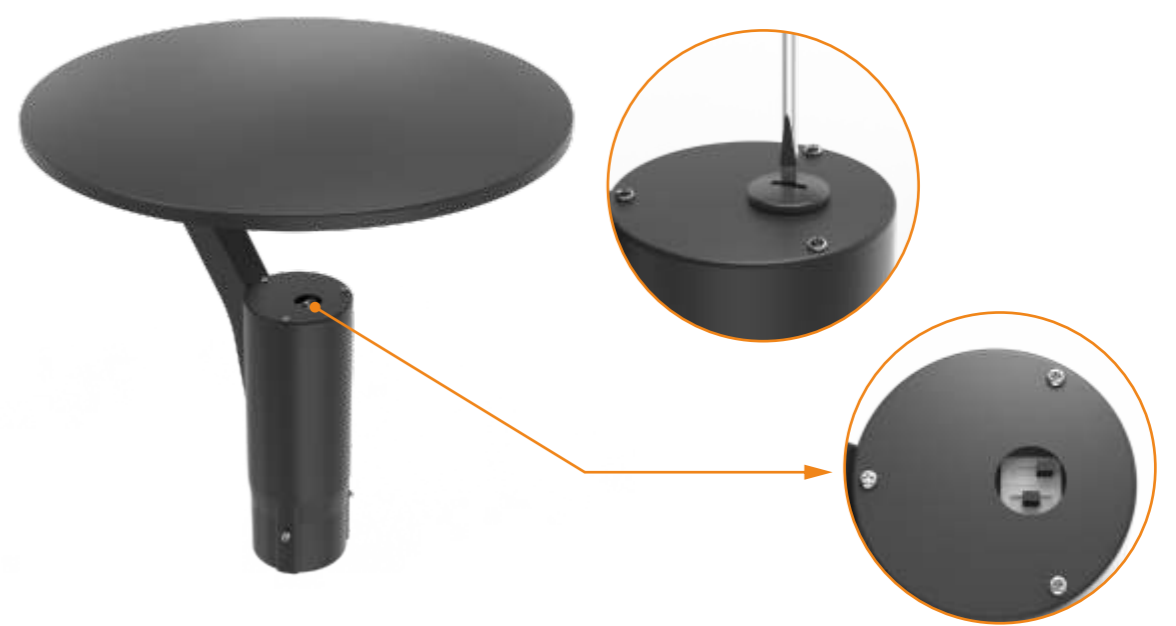
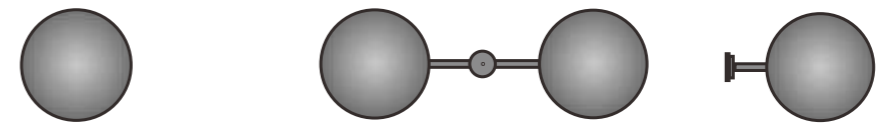

Wattage Switchable
30W / 40W / 50W
60W / 80W / 100W
100W / 120W / 150W

3 CCT Switchable
3000K-4000K-5000K

MARS SERIES

LED STREET LIGHT 25W - 200W

180 Lm/W

LED STREET LIGHT

MARS LED STREET LIGHTS

Constitute

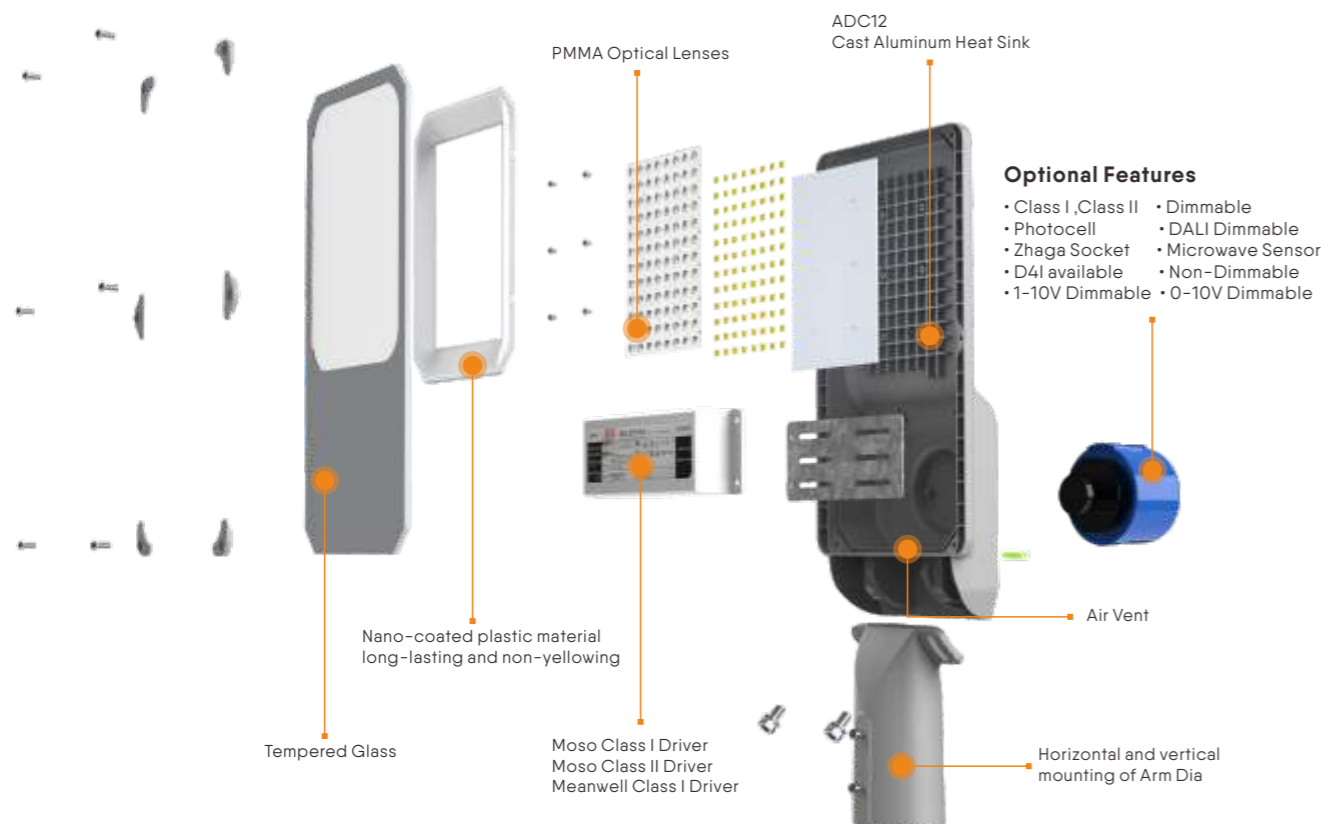

MARS

LED STREET LIGHTS 25W~200W

- Light Source: Lumileds
- Input Volt: 100-277Vac
- IP Rating: IP66 IK09
- Beam Angle: Type II, Type III, Type IV
- Color Temp: 3000-6000K
- Arm Dia: 60mm
- No external reflectors required
- 5 years warranty



	TINY MODEL	TINY MODEL	SMALL MODEL	SMALL MODEL
Model	LSMSL-T40W-LV(XXK)	LSMSL-T60W-LV(XXK)	LSMSL-S80W-LV(XXK)	LSMSL-S100W-LV(XXK)
Watt	40W	60W	80W	100W
Efficiency	150~180Lm/w±3%	150~180Lm/w±3%	150~180Lm/w±3%	150~180Lm/w±3%
Efficiency #2 #3	150~180Lm/w±3%	150~180Lm/w±3%	150Lm/w±3% 165Lm/w±3%	150Lm/w±3% 165Lm/w±3%
Lumen	7200Lm	10800Lm	14400Lm	18000Lm
Driver	Sosen & Moso	Sosen & Moso	Sosen & Moso	XLG-100-H-A
Surge protection	10KV	10KV	10KV	10KV

	MEDIUM MODEL	MEDIUM MODEL	LARGE MODEL	LARGE MODEL
Model	LSMSL-M120W-LV(XXK)	LSMSL-M150W-LV(XXK)	LSMSL-L180W-LV(XXK)	LSMSL-L200W-LV(XXK)
Watt	120W	150W	180W	200W
Efficiency #1	150~180Lm/w±3%	150~180Lm/w±3%	150~180Lm/w±3%	150~180Lm/w±3%
Efficiency #2 #3	150Lm/w±3% 165Lm/w±3%	150Lm/w±3% 165Lm/w±3%	150Lm/w±3% 165Lm/w±3%	150Lm/w±3% 165Lm/w±3%
Lumen	21600Lm	27000Lm	32400Lm	36000Lm
Driver	Sosen & Moso	Sosen & Moso	Sosen & Moso	Sosen & Moso
Surge protection	10KV	10KV	10KV	10KV

Beam Angle

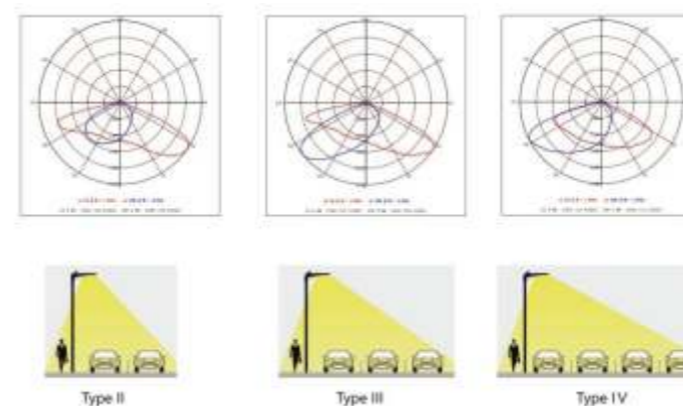

180 Lm/W

STREAMLINED PLUTO SERIES

LED STREET LIGHT 10W-300W



STREAMLINED PLUTO

LED STREET LIGHTS

- Light Source: Lumileds 3030
- Input Volt: 100-277VAC
- Input Volt: Dali& D4i is 200-240VAC
- IP Rating: IP66 IK08
- Beam Angle: Type II, Type III, Type IV
- Color Temp: 3000K 4000K 5000K 5700K
- Arm Dia: 60mm 48mm 42mm
- Lifespan: L90B10 >100,000hrs
- 5 years warranty



STREAMLINED DESIGN PLUTO LED STREET LIGHTS

Light-output compensation(CLO),time dimming control



▼ MOUNTING OPTIONS / PHOTOCELL

The Pluto led street fixture can be mounted horizontally or vertically with our universal slip fit system. Simply detach and rotate the slip fitter 180°. to achieve the vertical orientation. Both orientation options include the ability to rotate 15° or more.



Horizontal MOUNTING
Post-top position
(rotates ±15°)

Vertical MOUNTING
Side-entry position
(rotates ±15°)

Light-output compensation(CLO)
Time dimming control



Dimming Function
0 - 10V Continuous / PWM
Timing programmable, CLO
DALI Optional

Functional Controls
NEMA ro Zhaga

Technical Specifications

STREAMLINED PLUTO LED STREET LIGHTS 150LM/W

Part Number	LSPSL-40W-LV(XXK)	LSPSL-60W-LV(XXK)	LSPSL-80W-LV(XXK)	LSPSL-100W-LV(XXK)	LSPSL-120W-LV(XXK)
Watt	40W	60W	80W	100W	120W
Efficiency	150LM/W±3%	150LM/W±3%	150LM/W±3%	150LM/W±3%	150LM/W±3%
Chip Brand	Lumileds 5050	Lumileds 5050	Lumileds 5050	Lumileds 5050	Lumileds 5050
Lumen	6,000Lm	9,000Lm	12,000Lm	15,000Lm	18,000Lm
Driver	Sosen & Moso	Sosen & Moso	Sosen & Moso	Sosen & Moso	Sosen & Moso
Functional Controls	Class I Class II Zhaga D4i				
Terminal Block	included	included	included	included	included
Surge protection	10KV	10KV	10KV	10KV	10KV

Part Number	LSPSL-150W-LV(XXK)	LSPSL-180W-LV(XXK)	LSPSL-200W-LV(XXK)	LSPSL-250W-LV(XXK)	LSPSL-300W-LV(XXK)
Watt	150W	180W	200W	250W	300W
Efficiency	150LM/W±3%	150LM/W±3%	150LM/W±3%	150LM/W±3%	150LM/W±3%
Chip Brand	Lumileds 5050	Lumileds 5050	Lumileds 5050	Lumileds 5050	Lumileds 5050
Lumen	22,500Lm	27,000Lm	30,000Lm	37,500Lm	48,000Lm
Driver	Sosen & Moso	Sosen & Moso	Sosen & Moso	Sosen & Moso	Sosen & Moso
Functional Controls	Class I Class II Zhaga D4i				
Terminal Block	included	included	included	included	included
Surge protection	10KV	10KV	10KV	10KV	10KV

STREAMLINED PLUTO

180Lm/W

LED STREET LIGHTS



- Light Source: Lumileds 3030
- Input Volt: 100-277VAC
- IP Rating: IP66 IK08
- Beam Angle: Type II, Type III, Type IV
- Color Temp: 3000K 4000K 5000K 5700K
- Arm Dia: 60mm 48mm 42mm
- Lifespan: L90B10 >100,000hrs
- Photocell: On at Dusk and Off at Dawn. 0-10V NEMA dimming
- 5 years warranty



LED | IP66 | 100-277VAC 50/60Hz | DALI | ZDD1

Technical Specifications

STREAMLINED PLUTO LED STREET LIGHTS 165LM/W

Part Number	LSPSL-40W-LV(XXK)	LSPSL-60W-LV(XXK)	LSPSL-80W-LV(XXK)	LSPSL-100W-LV(XXK)	LSPSL-120W-LV(XXK)
Watt	40W	60W	80W	100W	120W
Efficiency	165LM/W±3%	165LM/W±3%	165LM/W±3%	165LM/W±3%	165LM/W±3%
Chip Brand	Lumileds 5050	Lumileds 5050	Lumileds 5050	Lumileds 5050	Lumileds 5050
Lumen	6,600Lm	9,900Lm	13,200Lm	16,500Lm	19,800Lm
Driver	Sosen & Moso	Sosen & Moso	Sosen & Moso	Sosen & Moso	Sosen & Moso
Functional Controls	Class I Class II Zhaga D4i				
Terminal Block	included	included	included	included	included
Surge protection	10KV	10KV	10KV	10KV	10KV

Part Number	LSPSL-150W-LV(XXK)	LSPSL-180W-LV(XXK)	LSPSL-200W-LV(XXK)	LSPSL-250W-LV(XXK)	LSPSL-300W-LV(XXK)
Watt	150W	180W	200W	250W	300W
Efficiency	165LM/W±3%	165LM/W±3%	165LM/W±3%	165LM/W±3%	165LM/W±3%
Chip Brand	Lumileds 5050	Lumileds 5050	Lumileds 5050	Lumileds 5050	Lumileds 5050
Lumen	24,750Lm	29,700Lm	33,000Lm	41,250Lm	49,500Lm
Driver	Sosen & Moso	Sosen & Moso	Sosen & Moso	Sosen & Moso	Sosen & Moso
Functional Controls	Class I Class II Zhaga D4i				
Terminal Block	included	included	included	included	included
Surge protection	10KV	10KV	10KV	10KV	10KV

Technical Specifications

STREAMLINED PLUTO LED STREET LIGHTS 180LM/W

Part Number	LSPSL-40W-LV(XXK)	LSPSL-60W-LV(XXK)	LSPSL-80W-LV(XXK)	LSPSL-100W-LV(XXK)	LSPSL-120W-LV(XXK)
Watt	40W	60W	80W	100W	120W
Efficiency	180LM/W±3%	180LM/W±3%	180LM/W±3%	180LM/W±3%	180LM/W±3%
Chip Brand	Lumileds 5050	Lumileds 5050	Lumileds 5050	Lumileds 5050	Lumileds 5050
Lumen	7200Lm	9000Lm	14400Lm	18000Lm	21600Lm
Driver	Sosen & Moso	Sosen & Moso	Sosen & Moso	Sosen & Moso	Sosen & Moso
Functional Controls	Class I Class II Zhaga D4i				
Terminal Block	included	included	included	included	included
Surge protection	10KV	10KV	10KV	10KV	10KV

Part Number	LSPSL-150W-LV(XXK)	LSPSL-180W-LV(XXK)	LSPSL-200W-LV(XXK)	LSPSL-250W-LV(XXK)	LSPSL-300W-LV(XXK)
Watt	150W	180W	200W	250W	300W
Efficiency	180LM/W±3%	180LM/W±3%	180LM/W±3%	180LM/W±3%	180LM/W±3%
Chip Brand	Lumileds 5050	Lumileds 5050	Lumileds 5050	Lumileds 5050	Lumileds 5050
Lumen	27000Lm	32400Lm	36000Lm	45000Lm	54000Lm
Driver	Sosen & Moso	Sosen & Moso	Sosen & Moso	Sosen & Moso	Sosen & Moso
Functional Controls	Class I Class II Zhaga D4i				
Terminal Block	included	included	included	included	included
Surge protection	10KV	10KV	10KV	10KV	10KV

Beam Angle

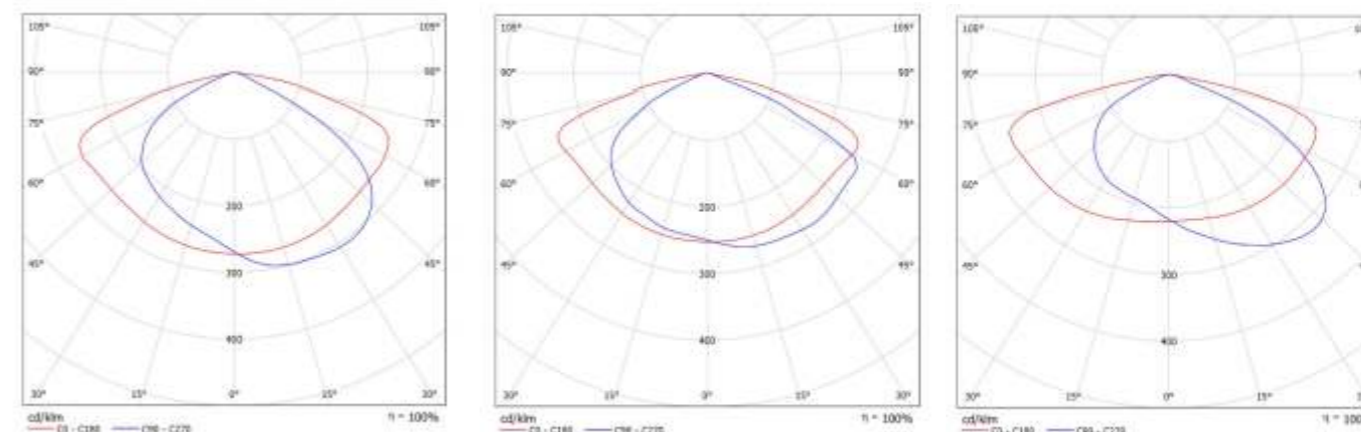

Type II

Type III

Type IV



SATURN SERIES

LED STREET LIGHT 30W-200W

SATURN

LED STREET LIGHTS

- Light Source: Lumileds
- Input Volt: 100-277VAC
- IP Rating IK Rating : IP67 IK08
- Beam Angle: 70x140°
- Color Temp: 3000-6000K
- Arm Dia: 60mm
- 5 years warranty

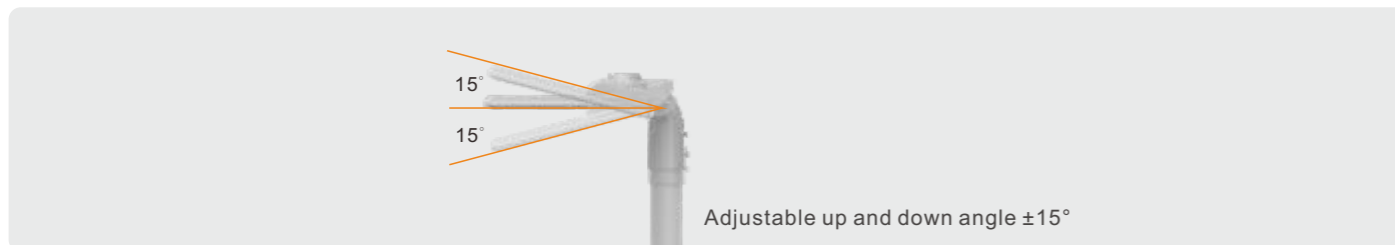

Part Number	LSSSL-30W(XXX)	LSSSL-50W(XXX)	LSSSL-80W(XXX)	LSSSL-100W(XXX)	LSSSL-120W(XXX)
Watt	30W	50W	80W	100W	120W
Efficiency	160lm/w±3%	160lm/w±3%	160lm/w±3%	160lm/w±3%	150lm/w±3%
Dimensions (mm)	501*127*78mm	548*147*78mm	588*206*78mm	588*206*78mm	588*206*78mm
Lumen	4,800Lm	8,000Lm	12,800Lm	16,000Lm	18,000Lm
Driver	Lampshining	Lampshining	Sosen/Lifud	Sosen/Lifud	Sosen/Lifud

Part Number	LSSSL-150W(XXX)	LSSSL-180W(XXX)	LSSSL-200W(XXX)
Watt	100W	120W	150W
Efficiency	160lm/w±3%	160lm/w±3%	160lm/w±3%
Dimensions (in)	669*222*78mm	718*237*78mm	718*237*78mm
Lumen	24,000Lm	28,800Lm	32,000Lm
Driver	Sosen/Lifud	Sosen/Lifud	Sosen/Lifud

Installation Accessories



2 Lights Adaptor Coner bracket L bracket for 60mm pole post top Wall Mount Bracket adaptor for dia 60mm spigot Corner Adaptor Rotatable adaptor (dia 60mm to dia60mm) (dia 60mm to dia76mm)

NEMA short cap 10KV SPD Photocell sensor NEMA 3-7pins



Beam Angle

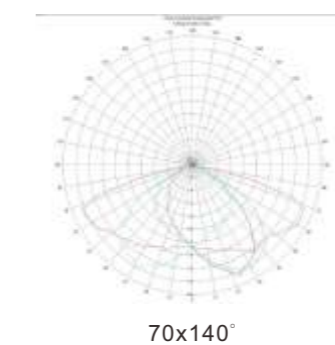



FOOD GRADE IP69K NSF CROWN LED HIGH BAY LIGHT



IP69K HI TEMP HI PRESSURE WASHDOWN

Water pressure 1450PSI, Water temperature 85 - Steam Cleanable



These lights are purpose-built for food preparation environments & are easily cleaned with an IP69K rated body. The surface of the light body is smooth, does not accumulate dust or grease, and is easy to clean with no exposed screws.

Diamond-shaped smooth surface perfect appearance design CROWN SERIES food led high bay lights has a smooth body without any remainder particles, which can not see any convex fins, screws or other projecting things on the surface. The seamless body is like a piece of modern art. Meanwhile, the smooth design won't pile up dust and makes cleaning work quite easy and save much labor cost.



FOOD GRADE HIGHBAY

CROWN LED HIGH BAY LIGHT

100W 150W 200W

- Light Source: Lumileds 2835
- Input Volt: 100-277VAC
- IK & IP Rating : IK10 & IP69K
- Beam Angle: Optic 90°/120° / 60° Aluminum Reflector
- Color Temp: 3000K - 6000K
- Operating Temperature: -30~45°C
- Size: Dia405x201mm
- 5 years warranty



Model	LSCHB-100W(XXK)	LSCHB-150W(XXK)	LSCHB-200W(XXK)
Watt	100W	150W	200W
Efficiency	160Lm/W±3%	160Lm/W±3%	160Lm/W±3%
Dimensions (mm)	Dia405xH201mm	Dia405xH201mm	Dia405xH201mm
Lumen	16,000Lm	22,500Lm	32,000Lm
Beam Angle	90°/120° Optic / Tempered Glass / 60° Aluminum Reflector		
Housing	White		
Power Supply	MOSO MNC-100V240	MOSO MNC-150V240	MOSO MNC-200V240

Model	LSCHB-100W(XXK)	LSCHB-150W(XXK)	LSCHB-200W(XXK)
Watt	100W	150W	200W
Efficiency	200Lm/w±5%	200Lm/w±5%	200Lm/w±5%
Dimensions (mm)	Dia405xH201mm	Dia405xH201mm	Dia405xH201mm
Lumen	20,000Lm	30,000Lm	40,000Lm
Beam Angle	90°/120° Optic / Tempered Glass / 60° Aluminum Reflector		
Housing	White		
Power Supply	MOSO MNC-100V240	MOSO MNC-150V240	MOSO MNC-200V240

Beam Angle

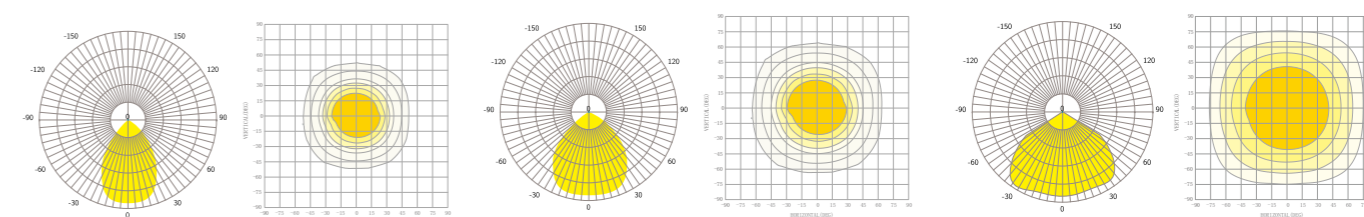

60°

90°

120°

Crown LED High Bay Light

3- POWER & 3-CCT SWITCHABLE

3 CCT SWITCHABLE



3 POWER SWITCHABLE



3 POWER SWITCHABLE



Selectable 3 power output and 3 CCT to suit multiple application environments. Convenient for you to prepare the inventory, then save your cost and warehouse space.

Diamond-shaped smooth surface perfect appearance design CROWN SERIES food led high bay lights has a smooth body without any remainder particles, which can not see any convex fins, screws or other projecting things on the surface. The seamless body is like a piece of modern art. Meanwhile, the smooth design won't pile up dust and makes cleaning work quite easy and save much labor cost.



CROWN LED HIGH BAY LIGHT

DIP CCT & Wattage Switchable

100W 120W 150W 200W

- Light Source: Lumileds 2835
- Input Volt: 100-277VAC
- IK & IP Rating : IK10 & IP69K
- Beam Angle: Optic 90°/120° / 60° Aluminum Reflector
- Color Temp: 3000K - 6000K
- Operating Temperature: -30~45°C
- Size: Dia405x201mm
- 5 years warranty



Model	LSCHE-100W(XXK)	LSCHE-150W(XXK)
Switchable wattages	100W/120W/150W	100W/150W/200W
Efficiency	160Lm/W±3%	160Lm/W±3%
Dimensions (mm)	Dia405xH201mm	Dia405xH201mm
Lumen	16,000Lm	22,500Lm
Switchable CCT	Single CCT 3000K/4000K/5000K	
Housing	White (Optional Gray, Black, Orange)	
Power Supply	Sosen SS-160NH-E260BH	Sosen SS-200NH-E260BH

Model	LSCHE-100W(XXK)	LSCHE-150W(XXK)
Switchable wattages	100W/120W/150W	100W/150W/200W
Efficiency	200Lm/W±5%	200Lm/W±5%
Dimensions (mm)	Dia405xH201mm	Dia405xH201mm
Lumen	20,000Lm	30,000Lm
Switchable CCT	Single CCT 3000K/4000K/5000K	
Housing	White (Optional Gray, Black, Orange)	
Power Supply	Sosen SS-160NH-E260BH	Sosen SS-200NH-E260BH

Beam Angle

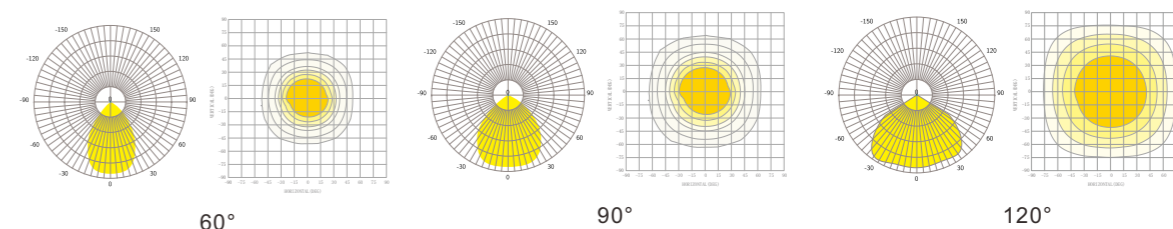



HIGH TEMPERATURE LED UFO HIGH BAY LIGHT



Ideal for high heat environments, petrochemical complexes, Paper Mills, Glass Factories Oil & Gas, Refineries, Power, Plants painting facilities, offshore platforms, oil and gas complexes, and more.

LED High Temperature High Bay Lighting is high heat resistant LED lighting built for temperatures up to 65°C (149°F). Designed specifically for use in hot climate regions such as in high temperature industrial applications such as die-cast facilities, foundries, iron forges, steel mills, power generation, chemical plants hot mills, pulp and paper plants, blast furnaces, etc. These industrial hot mills often experience drastic temperature fluctuations and require an industrial lighting solution with extremely high operating temperatures.



HIGH TEMPERATURE

LED HIGH BAY LIGHT

100W 150W 200W

- Light Source: Lumileds 3030
- Input Volt: 100-277Vac
- IK & IP Rating : IK10 & IP66
- Beam Angle: Optic 90°/120°
- Color Temp: 3000K - 6000K
- Working Temperature: 65°C
- Size: Dia400xH202mm
- 3 years warranty



Part Number	LSHUFO-100W(XXK)	LSHUFO-150W(XXK)	LSHUFO-200W(XXK)
Watt	100W	150W	200W
Efficiency	175Lm/w±3%	170Lm/w±3%	165Lm/w±3%
Dimensions (mm)	Dia400xH202	Dia400xH202	Dia400xH202
Lumen	17,500Lm	22,500Lm	33,000Lm
Beam Angle	90°/120° Optic Tempered Glass	90°/120° Optic Tempered Glass	90°/120° Optic Tempered Glass
Working Temperature	65	65	65

Beam Angle

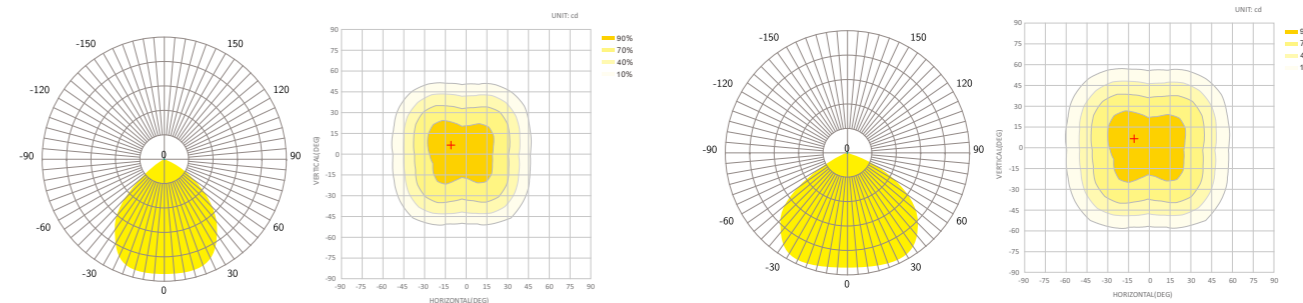

90°

120°

UFO LED HIGH BAY LIGHT ANTI CORROSION

Built to Last

Designed with only the highest quality in mind, the Crown LED High Bay Lights Anti Corrosion series combines high-end components for efficiency, with a superior build quality for reliability. High output Lumileds LED Chips ensures you will save on both energy and maintenance costs while meeting the highest performance standards.

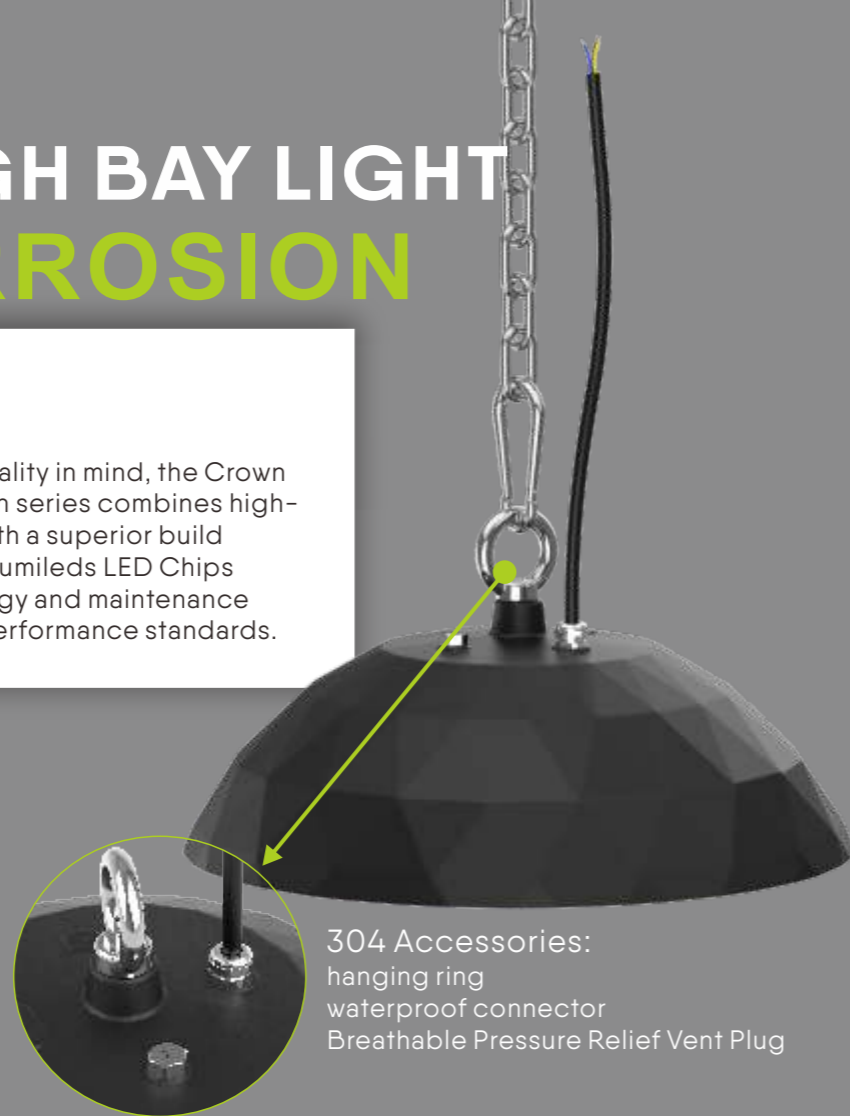

304 Accessories:
hanging ring
waterproof connector
Breathable Pressure Relief Vent Plug

Moisture Resistant

Damaging moisture can cut an LED light's life short. Whether it's a food processing plant with frequent wash downs, wash bays, or a water park, Crown LED High Bay Lights has fixtures designed to keep moisture out.

Anti Corrosion

To ensure the Crown LED High Bay Lights will survive even the toughest of conditions we constructed it out of die casting aluminum ADC12, the rest are made of stainless steel and coated it with a high performance pure epoxy anti-corrosion protective coating. For extra protection make sure you combine it with our 316 stainless steel.

ANTI CORROSION

LED HIGH BAY LIGHT
100W 150W 200W

- Light Source: Lumileds 3030
- Input Volt: 100-277Vac
- IK & IP Rating : IK08 & IP69K
- Beam Angle: Tempered glass
- Color Temp: 3000K - 6000K
- Operating Temperature: -30~45°C
- Size: Dia405xH201mm
- 3 years warranty



Part Number	LSCHB-100W(XXK)	LSCHB-150W(XXK)	LSCHB-200W(XXK)
Watt	100W	150W	200W
Efficiency	155Lm/w±3%	150Lm/w±3%	145Lm/w±3%
Dimensions (mm)	Dia405xH201mm	Dia405xH201mm	Dia405xH201mm
Lumen	15,500Lm	22,500Lm	29,000Lm
Housing	Black	Black	Black
Driver	MOSO MNC-100V240	MOSO MNC-150V240	MOSO MNC-200V240



Oil & Gas / Mining / Gas Canopy Lighting / Food processing plants / Power Generation
Foundries / Paper and Pulp Mills / Desalination Plants / Chemical Plants / Water & Sewage

Mounting & Accessories Options



Eyebolt Mount

Pendant Mount

Ceiling Mount

Safety cable

Motion sensor

PC & Aluminum reflector

200 Lm/W

6th GEN
LED UFO High Bay Light



6TH GEN
UFO LED HIGH BAY LIGHT

- Light Source: Lumileds
- Input Volt: 200-277Vac
- Beam Angle: 60° / 90° / 120°
- CCT Adjustable: 4000K~6000K
- High luminaire efficiency up to 200Lm/w
- Mounting Height: 6-12meter
- Housing is made of die casting aluminum ADC12
- 5 years warranty



200-277V / 100-277V
 50,000H
 Dimmable
 -30~45°C
 IK10
 IP65

Lighter In Weight Smaller In Size
Save Shipping Cost High Lumens Efficacy

60W	100W	150W	200W
240W	300W	400W	500W

Technical Specifications

Model	Watt	Efficiency	Lumen	Efficiency	Lumen	Size(mm)
LSUFO-60WXYLVS(XXX)	60W	160lm/w±5%	9,600Lm	200lm/w±5%	12,000Lm	Dia235*H151
LSUFO-100WXYLVS(XXX)	100W	160lm/w±5%	16,000Lm	200lm/w±5%	20,000Lm	Dia254*H151
LSUFO-150WXYLVS(XXX)	150W	160lm/w±5%	24,000Lm	200lm/w±5%	30,000Lm	Dia254*H151
LSUFO-200WXYLVS(XXX)	200W	160lm/w±5%	32,000Lm	200lm/w±5%	40,000Lm	Dia299*H153
LSUFO-240WXYLVS(XXX)	240W	160lm/w±5%	38,400Lm	200lm/w±5%	48,000Lm	Dia365*H153
LSUFO-300WXYLVS(XXX)	300W	160lm/w±5%	48,000Lm	200lm/w±5%	60,000Lm	Dia385*H174
LSUFO-400WXYLVS(XXX)	400W	150lm/w±5%	60,000Lm	170lm/w±5%	68,000Lm	Dia400*H193
LSUFO-500WXYLVS(XXX)	500W	150lm/w±5%	75,000Lm	170lm/w±5%	85,000Lm	Dia490*H199

Beam Angle

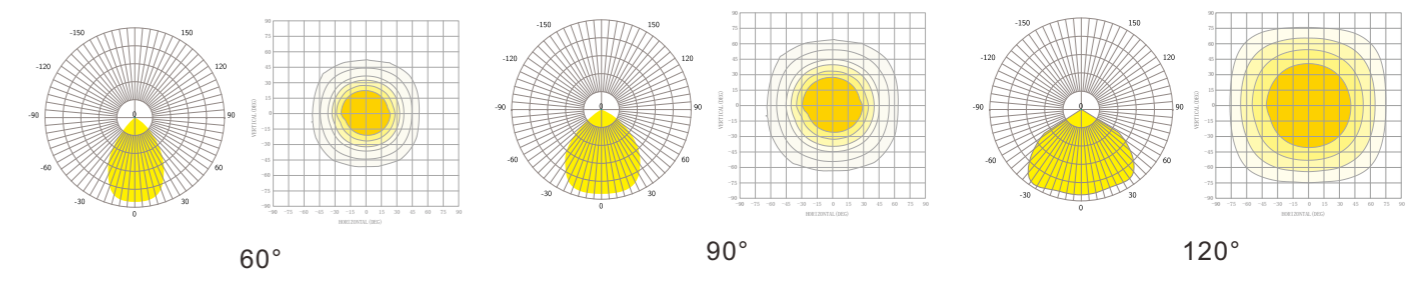

200 Lm/W

6th GEN UFO SERIES

Wattage/CCT adjustable LED UFO High Bay Light



HIGH LUMINAIRE EFFICIENCY

High luminaire efficiency up to 200Lm/w
Mounting Height: 6-12meter

WATTAGE SLECTABLE **CCT SLECTABLE**

These items can be switched to 4000K,5000K or 6000K from buttons on power supply,it's easier to stock only one SKU and sell at different wattages and color temperatures.



6th GEN UFO SERIES

WATTAGE & CCT SLECTABLE

UFO LED HIGH BAY LIGHT 100W~240W

- Light Source:Osram 2835
- Input Volt: 100-277Vac
- Beam Angle: 60° /90° / 120°
- CCT Adjustable: 4000K-5000K-6000K
- High luminaire efficiency up to 200Lm/w
- Mounting Height: 6-12meter
- Housing is made of die casting aluminum ADC12
- 5 years warranty

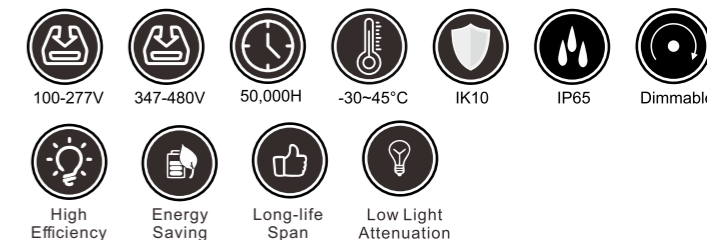

Technical Specifications

Model	Watt	Wattage adjustable	CCT adjustable	Efficiency	Lumen	Driver	Flickering	CRI	Size(mm)	Beam angle
LSUFO-100WXY-LVS(XXK)	100W	60W 80W 100W	4000K 5000K 6000K	160lm/w±5%	16,000Lm	Sosen	Free	>70	Dia254*H151	60°/90°/120°
LSUFO-150WXY-LVS(XXK)	150W	80W 100W 150W	4000K 5000K 6000K	160lm/w±5%	24,000Lm	Sosen	Free	>70	Dia254*H151	60°/90°/120°
LSUFO-200WXY-LVS(XXK)	200W	100W 150W 200W	4000K 5000K 6000K	160lm/w±5%	32,000Lm	Sosen	Free	>70	Dia299*H153	60°/90°/120°
LSUFO-240WXY-LVS(XXK)	240W	150W 200W 240W	4000K 5000K 6000K	160lm/w±5%	38,400Lm	Sosen	Free	>70	Dia365*H153	60°/90°/120°
LSUFO-100WXY-LVS(XXK)	100W	60W 80W 100W	4000K 5000K 6000K	200lm/w±5%	20,000Lm	Sosen	Free	>70	Dia254*H151	60°/90°/120°
LSUFO-150WXY-LVS(XXK)	150W	80W 100W 150W	4000K 5000K 6000K	200lm/w±5%	30,000Lm	Sosen	Free	>70	Dia299*H153	60°/90°/120°
LSUFO-200WXY-LVS(XXK)	200W	100W 150W 200W	4000K 5000K 6000K	200lm/w±5%	40,000Lm	Sosen	Free	>70	Dia365*H153	60°/90°/120°
LSUFO-240WXY-LVS(XXK)	240W	150W 200W 240W	4000K 5000K 6000K	200lm/w±5%	48,000Lm	Sosen	Free	>70	Dia385*H174	60°/90°/120°

Beam Angle

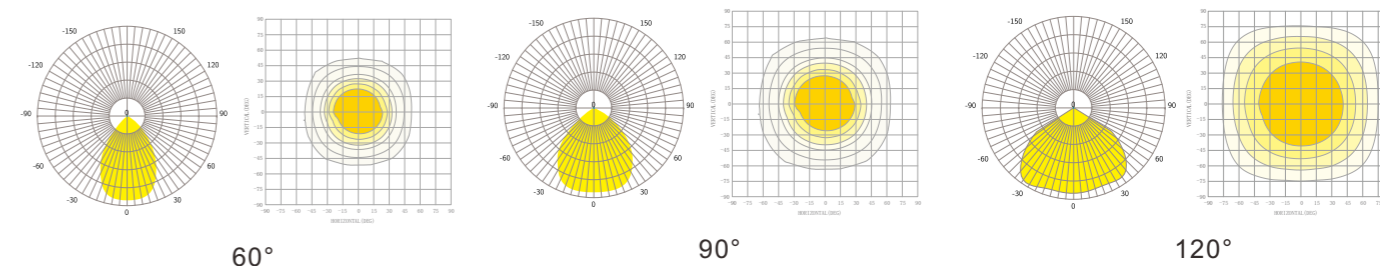

200 Lm/W

MOTION SENSOR SERIES

GRAPHENE UFO LED HIGH BAY LIGHT

High Luminaire Efficiency

High luminaire efficiency up to 200lm/w, CRI > 80
Mounting Height: 8-15meter



Unscrew the panel clockwise



Plug and Play



Screw on the sensor counterclockwise



On/off control



Stand-by dimming level



Detection area



Remote control setting



Hold time



10-15M Highbay altitude



Daylight sensor



Stand-by period



Dimmable

Lamp comes with short cap, you are able to twist and lock the sensor easily. Motion sensor need to be ordered separately, easy for stock.



Motion Sensor

Built-in induction sensor UFO led high bay light

- Light Source: SMD 2835
- Input Volt: 100-277VAC
- IP Rating: IP65
- Beam angle: 60°/90°/120°
- Sensor detective: <10meters
- Dimming: 0-10V Switch off
- Color Temp: 4000~6000K
- 5 years warranty



100-277V
347-480V



50,000H



Dimmable



-30~45°C



Ik10



IP65



Part Number	LSUFO-100WXY-GS(XXX)	LSUFO-150WXY-GS(XXX)	LSUFO-200WXY-GS(XXX)	LSUFO-240WXY-GS(XXX)
Watt	100W	150W	200W	240W
Efficiency	160Lm/W 200Lm/W	160Lm/W 200Lm/W	160Lm/W 200Lm/W	160Lm/W 200Lm/W
Dimensions (mm)	Dia254xH151	Dia299xH153	Dia299xH153	Dia365xH153
Lumen	16,000Lm 20,000Lm	24,000Lm 30,000Lm	32,000Lm 40,000Lm	38,400Lm 48,000Lm
Driver (MOSO)	Sosen/Lifud	Sosen/Lifud	Sosen/Lifud	Sosen/Lifud
Wattage Adjustable	60W-80W-100W	80W-120W-150W	100W-150W-200W	150W-200W-240W

Lux on/off

Preconditions to use the Lux-off function:

1. Standby period is +∞;
2. Standby dimming level is on 10%, 20% or 30%;
3. Daylight threshold is on 30Lux, 50Lux, 80Lux or 120Lux.

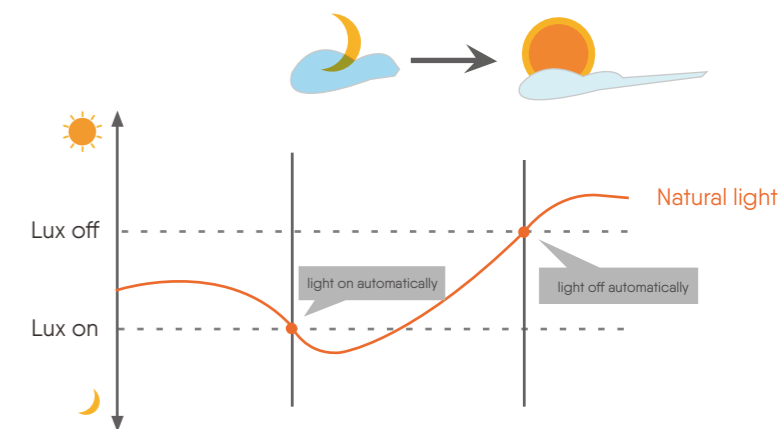

Application—Lux on/off

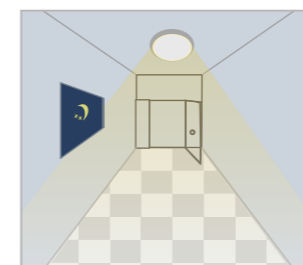

Light automatically on when ambient brightness is lower than preset lux level.



With insufficient ambient brightness, light dims to 100% when motion detected.

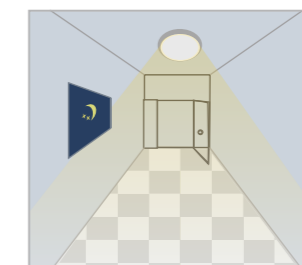

Light dims to standby level if no motion detected after holdtime.

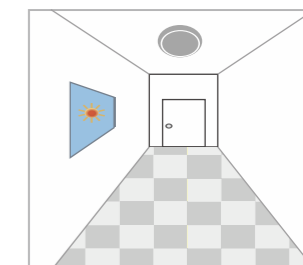

Light off when ambient lux level is higher than preset lux amount.

180 Lm/W

LINEAR SERIES

LED HIGH BAY LIGHT



LINEAR

LED HIGH BAY LIGHT

- Light Source: Lumiled 2835
- Input Volt: 100-277VAC
- IP & IK Rating : IP65 & IK10
- Beam Angle: 40°/60°/90°/120°/40*100°/P50
- Color Temp: 3000K-6000K
- Each lamp comes with 2sets of 1m irerope+2hooks
- Surge protection: 6KV
- Suspension mount or Ceiling mount
- 5 years warranty



100-277V



347-480V



Dimmable



50,000H



IP65



IK10



Dust Proof



-30~45°C



Motion Sensor Optional

LINEAR LED HIGH BAY LIGHT FIXTURES

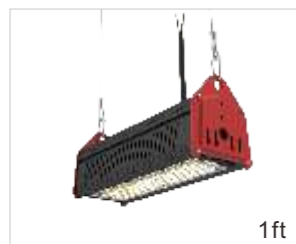

1ft

LSLHBL-50W



2ft

LSLHBL-100W



3ft

LSLHBL-150W

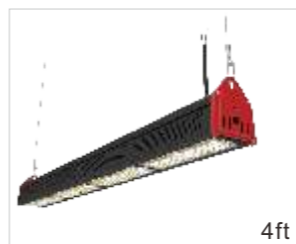

4ft

LSLHBL-200W

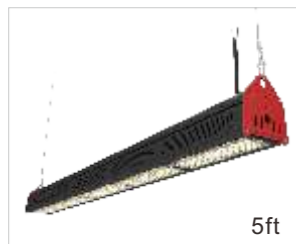

5ft

LSLHBL-240W

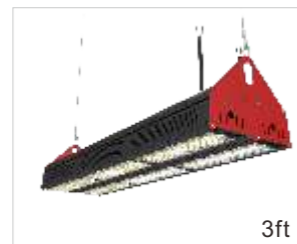

3ft

LSLHBL-300W

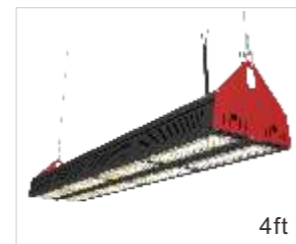

4ft

LSLHBL-400W

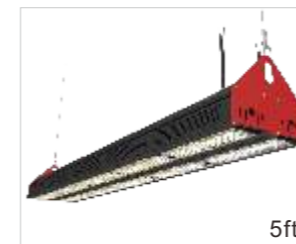

5ft

LSLHBL-500W



Wall Mount Kits



AC Motion Senso



DC Motion Senso

SPECIFICATIONS INFORMATION

Model	Watt	Input Voltage	Efficiency #1	Lumen #1	Efficiency #2	Lumen #2	Driver
LSLHBL-50W	50W	100-277VAC	160LM/W±3%	8,000Lm	180LM/W±3%	9,000Lm	Sosen
LSLHBL-100W	100W	100-277VAC	160LM/W±3%	16,000Lm	180LM/W±3%	18,000Lm	Meanwell/Sosen/MOSO
LSLHBL-150W	150W	100-277VAC	160LM/W±3%	24,000Lm	180LM/W±3%	27,000Lm	Meanwell/Sosen/MOSO
LSLHBL-200W	200W	100-277VAC	160LM/W±3%	32,000Lm	180LM/W±3%	36,000Lm	Meanwell/Sosen/MOSO
LSLHBL-240W	240W	100-277VAC	160LM/W±3%	38,400Lm	180LM/W±3%	43,200Lm	Meanwell/Sosen/MOSO
LSLHBL-300W	300W	100-277VAC	160LM/W±3%	48,000Lm	180LM/W±3%	54,000Lm	Meanwell/Sosen/MOSO
LSLHBL-400W	400W	100-277VAC	160LM/W±3%	64,000Lm	180LM/W±3%	72,000Lm	Meanwell/Sosen/MOSO
LSLHBL-500W	500W	100-277VAC	160LM/W±3%	80,000Lm	180LM/W±3%	90,000Lm	Meanwell/Sosen/MOSO

Beam Angle

Symmetrical Angle

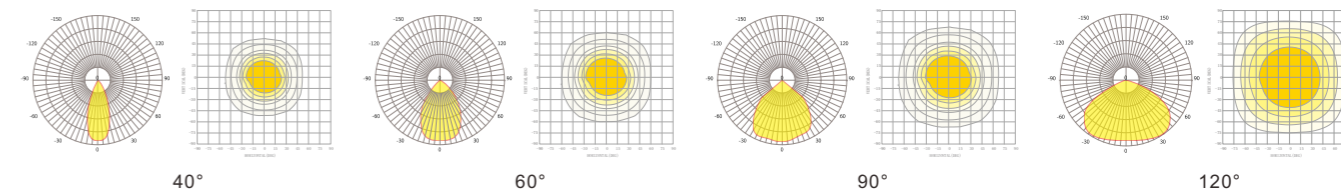

Polarization Angle

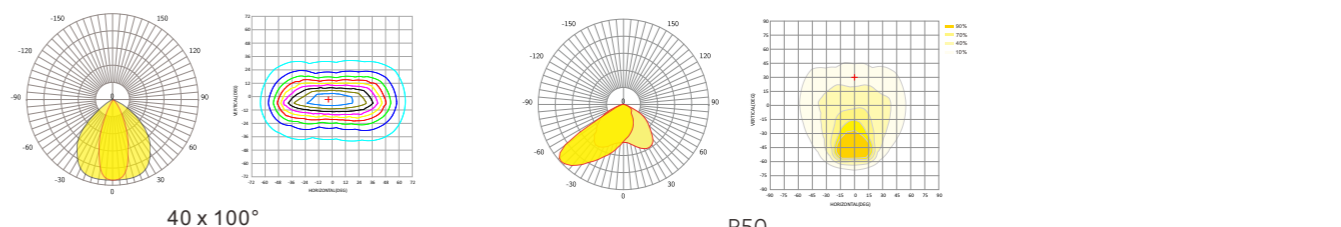



180 Lm/W

Anti Glared
Special design for tennis court retrofit lighting

NEMO SERIES
LED FLOODLIGHTING

NEMO
LED FLOODLIGHTING

- Light Source: Lumileds 5050
- Input Volt: 100-277VAC
- IP&IK Rating: IP66 & IK08
- Color Temp: 3000K~6000K
- Beam angle: Symmetrical 20°/40°/60°/90°
- Beam angle: Asymmetrical T2/T3/FT60/FT45/FT6W/P50/P60
- Various lens, PCB board and drivers changeable
- 5 years warranty



▲ Linkable Floodlights available

100-277V 50,000H Dimmable -30~45°C IK08 IP66

TENNIS COURT LIGHTING

Anti Glaring Special for tennis court

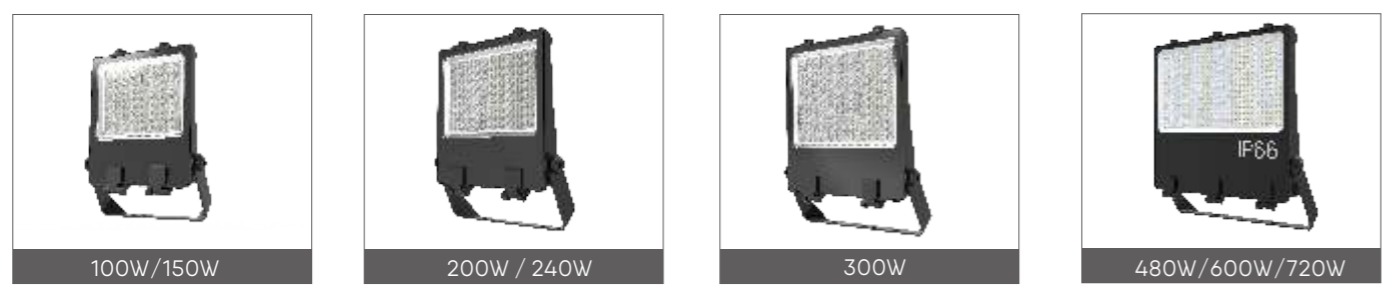

Outdoor tennis court simulation based on LSNFL-300W(XXX) P60 asymmetrical optic
P50/P60/FT60/FT45/FT6W asymmetrical optics are designed for tennis court and football field, lamp will be installed horizontally, no light pollution to sky, no glare to audiences or neighbours's space, **Glare Rating less than 45, uniformity is as high as up to 0.7**

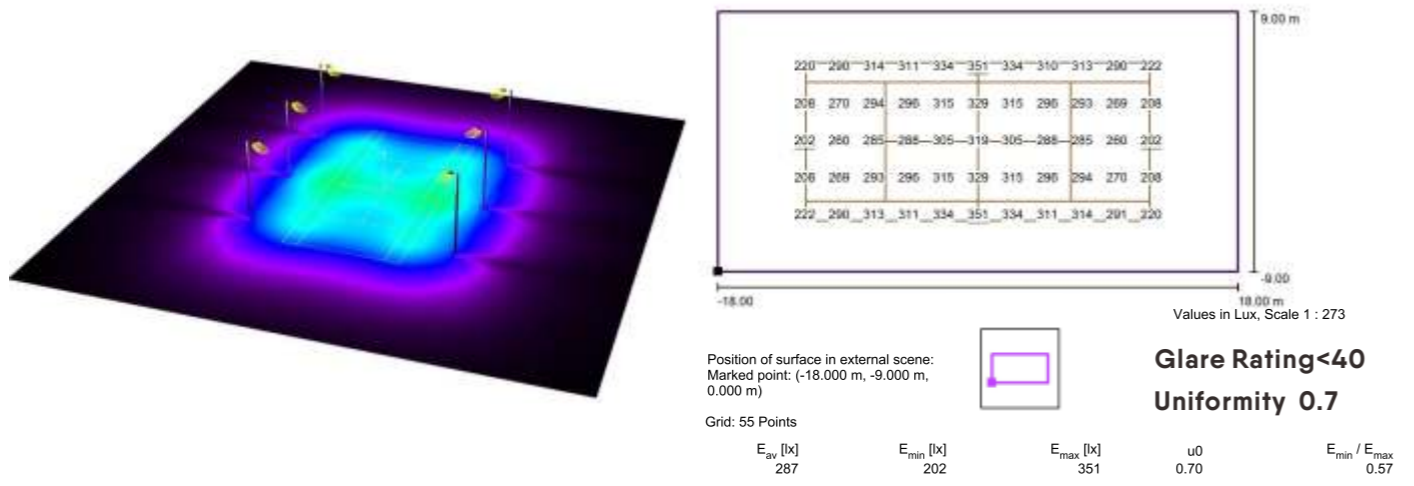

SPECIFICATIONS INFORMATION

Model	Watt	Efficiency#1	Lumen	Efficiency#2	Lumen	SPD (Optional)	Lumen	Weight
LSNFL-100W(XXX)	100W	160LM/W±3%	16,000Lm	180LM/W±3%	18,000Lm	10KV/20KV	Meanwell driver Or Sosen driver	6.5kg
LSNFL-150W(XXX)	150W	155LM/W±3%	22,500Lm	180LM/W±3%	27,000Lm	10KV/20KV		6.5kg
LSNFL-200W(XXX)	200W	150LM/W±3%	30,000Lm	180LM/W±3%	36,000Lm	10KV/20KV		7.2kg
LSNFL-240W(XXX)	240W	150LM/W±3%	36,000Lm	180LM/W±3%	43,200Lm	10KV/20KV		7.2kg
LSNFL-300W(XXX)	300W	155LM/W±3%	46,500Lm	180LM/W±3%	54,000Lm	10KV/20KV		10kg
LSNFL-480W(XXX)	480W	180LM/W±3%	86,400Lm	190LM/W±3%	91,200Lm	10KV/20KV		14.6kg
LSNFL-600W(XXX)	600W	175LM/W±3%	105,000Lm	185LM/W±3%	111,000Lm	10KV/20KV		15.6kg
LSNFL-720W(XXX)	720W	165LM/W±3%	118,800Lm	175LM/W±3%	126,000Lm	10KV/20KV		17.0kg



P50 P60 T2 T3 Lumen efficiency:
100W: 165Lm/w±3% 150W: 160lm/w±3% 200W: 165lm/w±3% 240W: 160lm/w±3% 300W: 163lm/w±3%

FT60/FT45/FT6W Lumen efficiency:
100W: 137Lm/w±3% 150W: 130lm/w±3% 200W: 120lm/w±3% 300W: 125lm/w±3% 480W: 132lm/w±3% 600W: 125lm/w±3%

Beam Angle

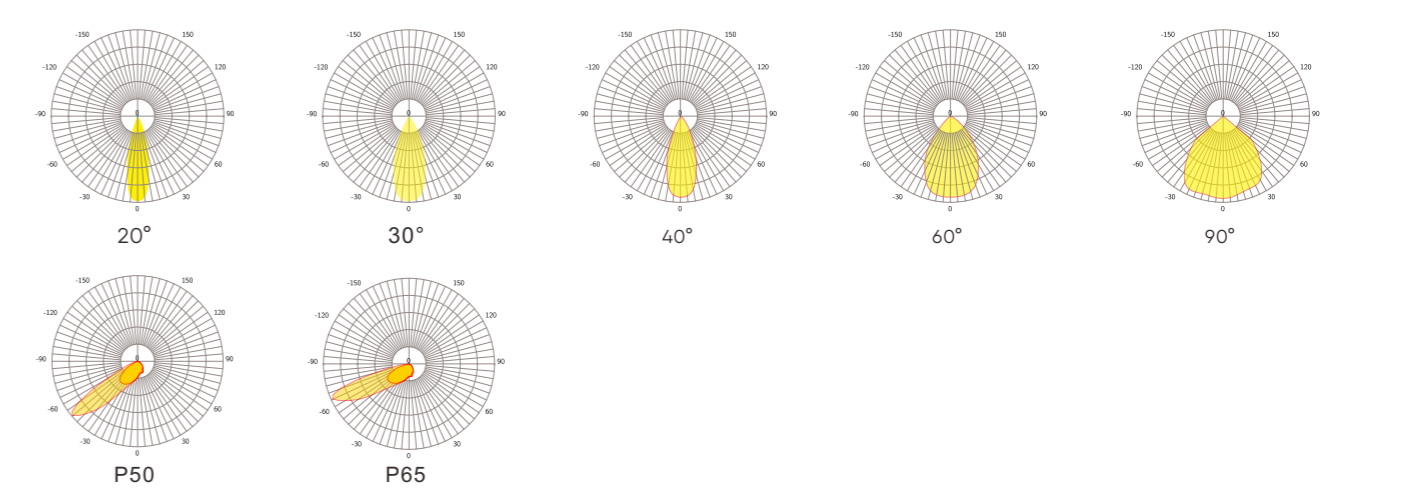

170 Lm/W

NEMO EKO SERIES

LED FLOODLIGHTING



NEMO EKO

LED FLOODLIGHTING

- Light Source: Lumileds 5050
- Input Volt: 100-277VAC / 200-240VAC
- IP Rating: IP66 IK08
- Certificates: ETL DLC ENEC TUV CE RoHS CB SAA
- Color Temp: 4000K 5000K 5700K
- Buckle design, tool free open and maintenance
- Various lens, PCB board and drivers changeable
- 5 years warranty

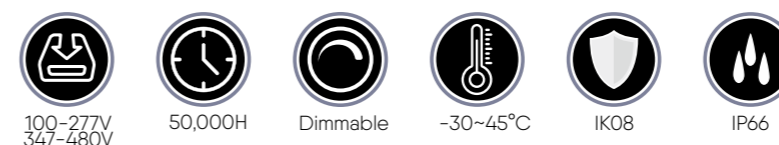

Part Number	LSNFL-50W(XXX)EKO	LSNFL-75W(XXX)EKO	LSNFL-100W(XXX)EKO	LSNFL-150W(XXX)EKO	LSNFL-200W(XXX)EKO
Watt	50W	75W	100W	150W	200W
Efficiency	150Lm/W or 170Lm/W	145Lm/W or 170Lm/W	145Lm/W or 165Lm/W	160Lm/W or 175Lm/W	165Lm/W or 175Lm/W
Dimensions (mm)	441x357x60mm	441x357x60mm	447x387x60mm	447x387x60mm	518x477x60mm
Lumen	7,500Lm / 8,500Lm	10,875Lm / 12,750Lm	14,500Lm / 16,500Lm	24,000Lm / 26,250Lm	33,000Lm / 35,000Lm
Driver	MNC-100V240	MNC-100V240	MNC-100V240	MNC-150V240	MNC-200V240



TENNIS COURT LIGHTING

Buckle design, tool free open and maintenance



ACCESSORY: PHOTOCELL Optional

This fixture is optional with photocell sensor

- Photocell integration controls 120-277Volt



Photocell
On at Dusk and Off at Dawn.
NEMA 7Pin

ACCESSORY: SURGE PROTECTION DEVICE

This fixture is optional with 10KV or 20KV SPD. SPD surge protection devices is perfectly adapted for outdoor lighting to provide single phase protection for line/neutral, line/ground and neutral/ground in accordance with IEEE C62.41 2002 C High, UL1449 and IEC61643-11



10KV 20KV
Optional



Open tool-free

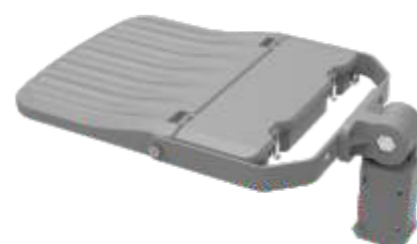

Slip Fitter

Beam Angle

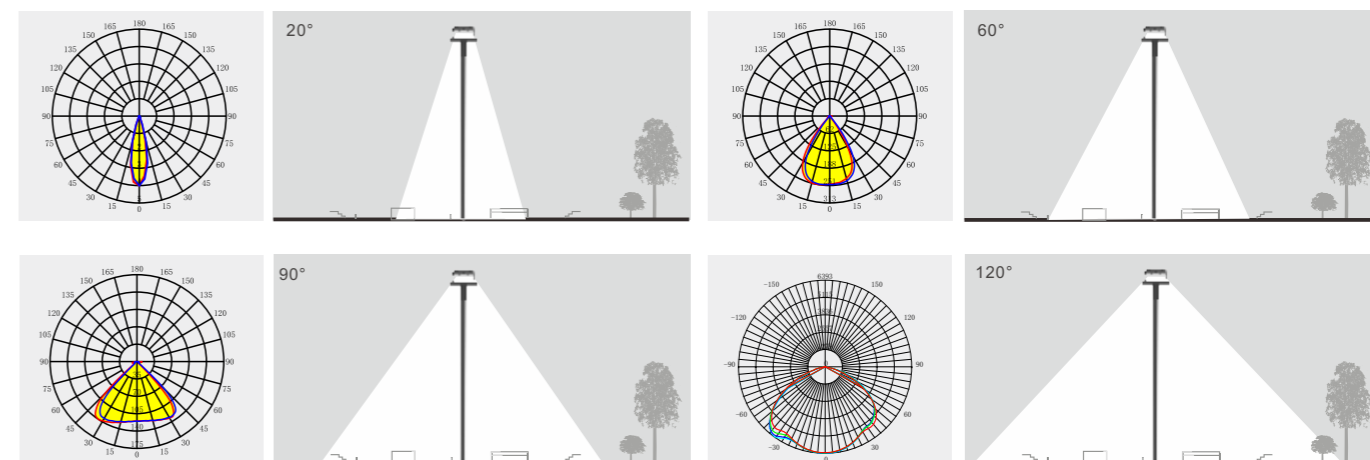

Special for tennis court (Anti-Glaring)

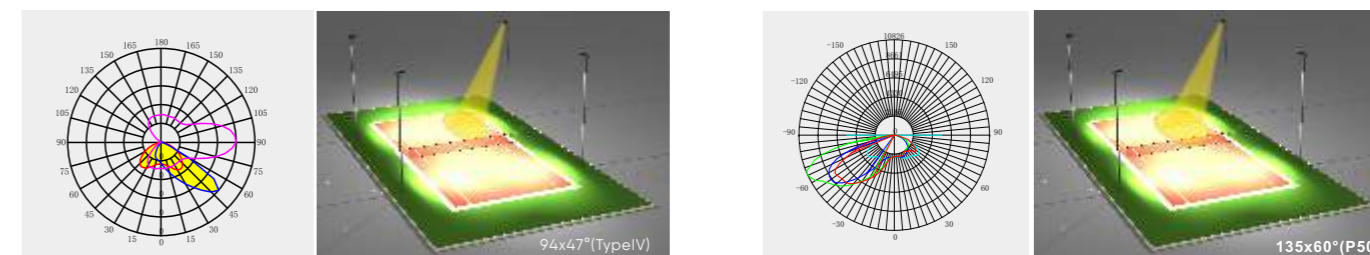

190 Lm/W

EKO SERIES

LED FLOODLIGHT 30W - 600W

EKO LED FLOOD LIGHTS

die-cast aluminum enclosure resists corrosion, dust, insects, and weather

EKO LED Floodlight 30-600Watt

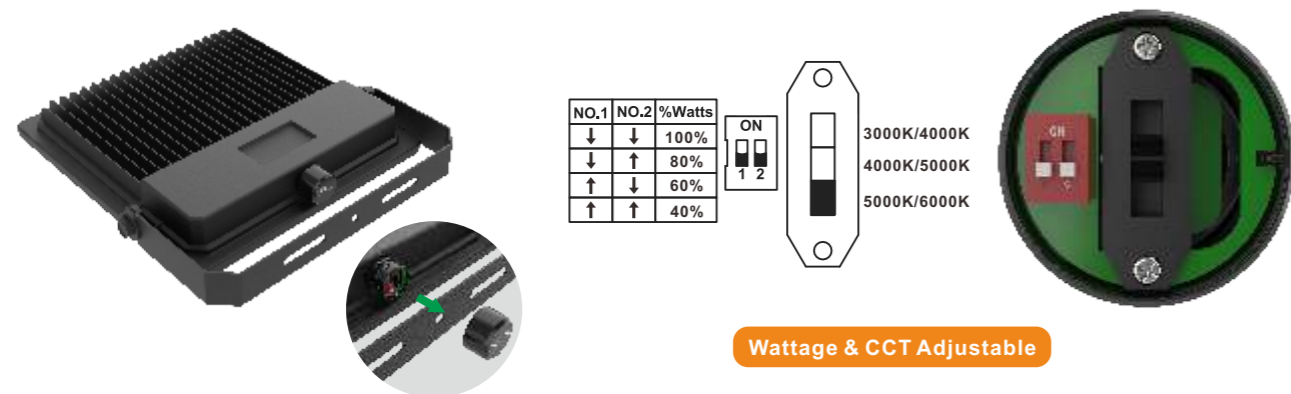

EKO

LED FLOODLIGHT

- Light Source: Lumileds
- Light Source: Lumileds
- Input Volt: 100-277VAC
- IP & IK Rating : IP66 & IK08
- Color Temp: 3000~6000K
- Certificate: ETL DLC TUV CE CB SAA RoHS
- Beam Angle: 30°/60°/90°/120° Type2/Type3/Type4
- 5 years warranty



Technical Specifications

Model	Watt	Effency #1	Lumen #1	Effency #2	Lumen #2	IP & IK	Driver
LSSFL-30W	30W	160-170LM/W	5,100Lm	180-190LM/W	5,700Lm	IP66&IK08	Kehua
LSSFL-50W	50W	160-170LM/W	8,500Lm	180-190LM/W	9,500Lm	IP66&IK08	Kehua
LSSFL-100W	100W	160-170LM/W	17,000Lm	180-190LM/W	19,000Lm	IP66&IK08	sofen/Lifud/moso
LSSFL-150W	150W	160-170LM/W	25,500Lm	180-190LM/W	28,500Lm	IP66&IK08	sofen/Lifud/moso
LSSFL-200W	200W	160-170LM/W	34,000Lm	180-190LM/W	38,000Lm	IP66&IK08	sofen/Lifud/moso
LSSFL-240W	240W	160-170LM/W	42,000Lm	180-190LM/W	45,600Lm	IP66&IK08	sofen/Lifud/moso
LSSFL-300W	300W	160-170LM/W	51,000Lm	180-190LM/W	57,000Lm	IP66&IK08	sofen/Lifud/moso
LSSFL-400W	400W	160-170LM/W	68,000Lm	180-190LM/W	76,000Lm	IP66&IK08	sofen/Lifud/moso
LSSFL-480W	480W	160-170LM/W	81,600Lm	180-190LM/W	91,200Lm	IP66&IK08	sofen/Lifud/moso
LSSFL-600W	600W	160-170LM/W	102,000Lm	180-190LM/W	102,000Lm	IP66&IK08	sofen/Lifud/moso

Beam Angle

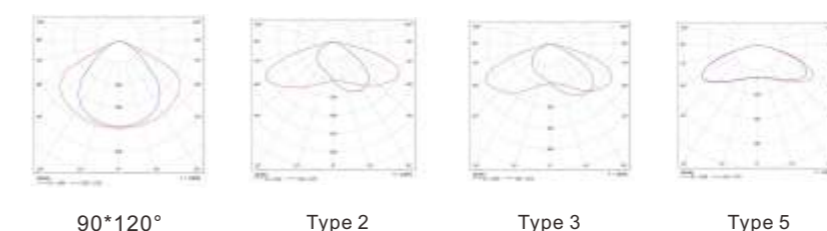
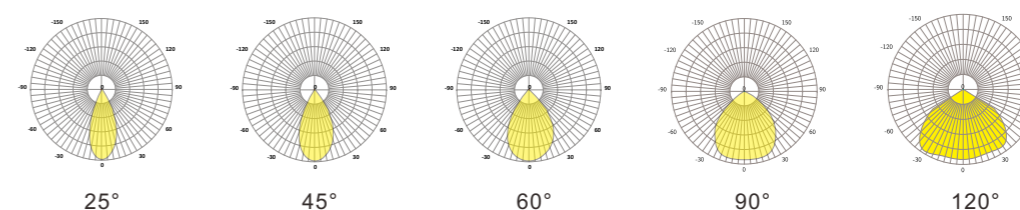

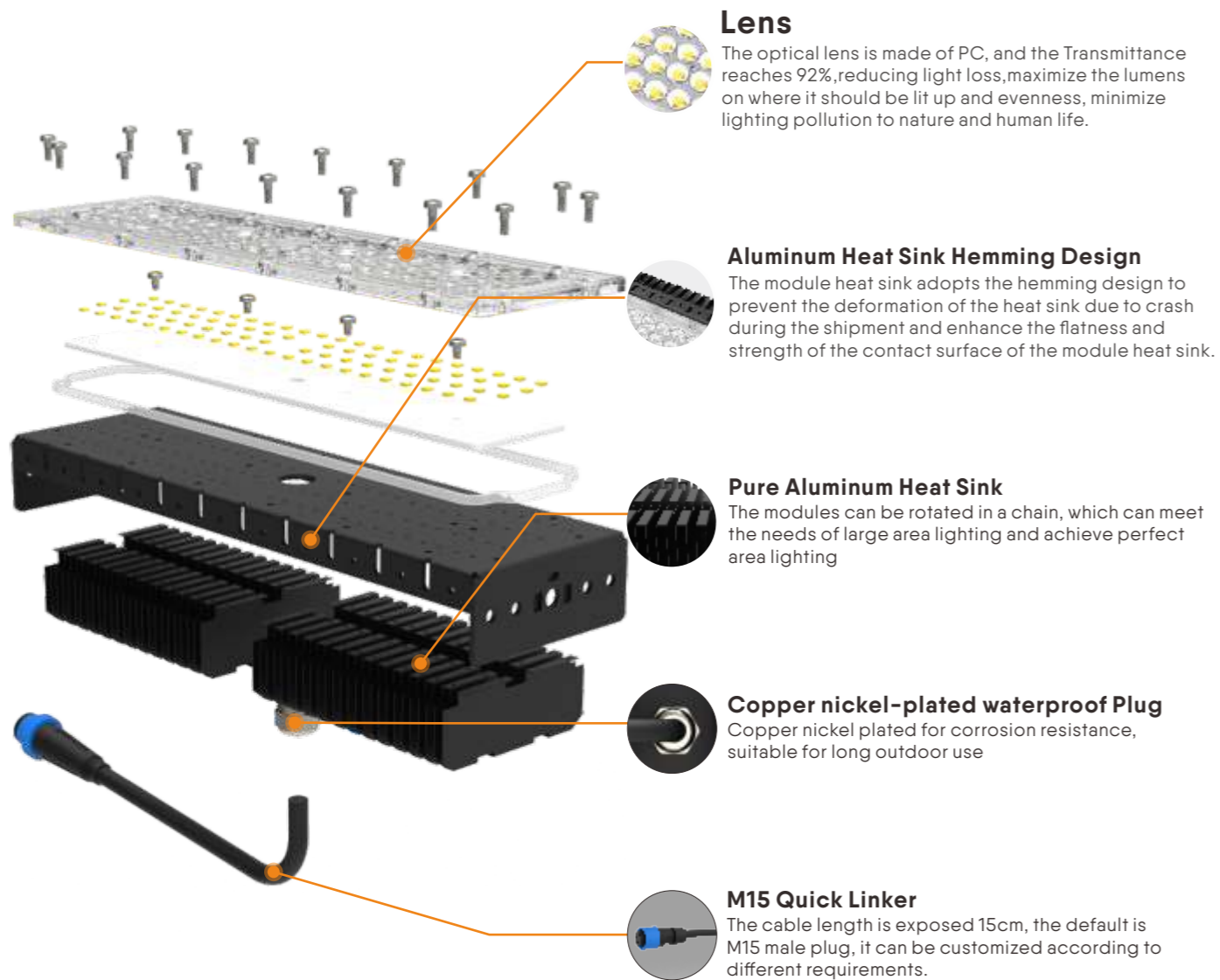

Lens
The optical lens is made of PC, and the Transmittance reaches 92%, reducing light loss, maximize the lumens on where it should be lit up and evenness, minimize lighting pollution to nature and human life.

Aluminum Heat Sink Hemming Design
The module heat sink adopts the hemming design to prevent the deformation of the heat sink due to crash during the shipment and enhance the flatness and strength of the contact surface of the module heat sink.

Pure Aluminum Heat Sink
The modules can be rotated in a chain, which can meet the needs of large area lighting and achieve perfect area lighting

Copper nickel-plated waterproof Plug
Copper nickel plated for corrosion resistance, suitable for long outdoor use

M15 Quick Linker
The cable length is exposed 15cm, the default is M15 male plug, it can be customized according to different requirements.



PROE

Folding Aluminum Fin LED Module



- Light Source: Luminleds 3030
- Input Volt: 42VDC
- IP Rating IK Rating : IP66 & IK10
- Beam Angle: 15° 25° 40° 60° 90° 120°
30x70° 49x21° 136x78°
- Color Temp: 3000K 4000K 5000K 5700K 6000K
- Plug: M15 2Pin Male Plug
- 5 years warranty

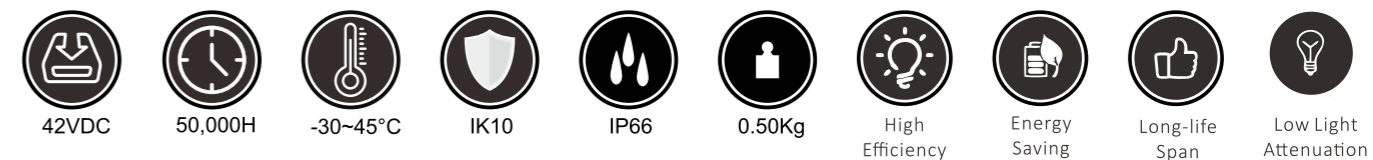

Technical Specifications

Part Number	Watt	Dtiver	Efficiency	Chip Brand	Lumen	CCT	Net Weight
LSM-50W-PROE	50W	Not included	140LM/W±3%	Luminleds 3030	7,000Lm	3000-6000K	0.5KG
LSM-50W-PROE	50W	Not included	170LM/W±3%	Luminleds 3030	8,500Lm	3000-6000K	0.5KG

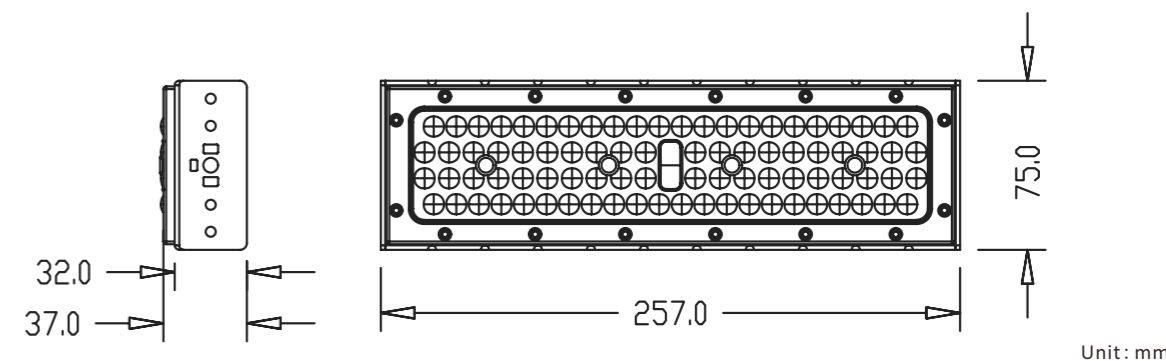

Unit: mm

Beam Angle

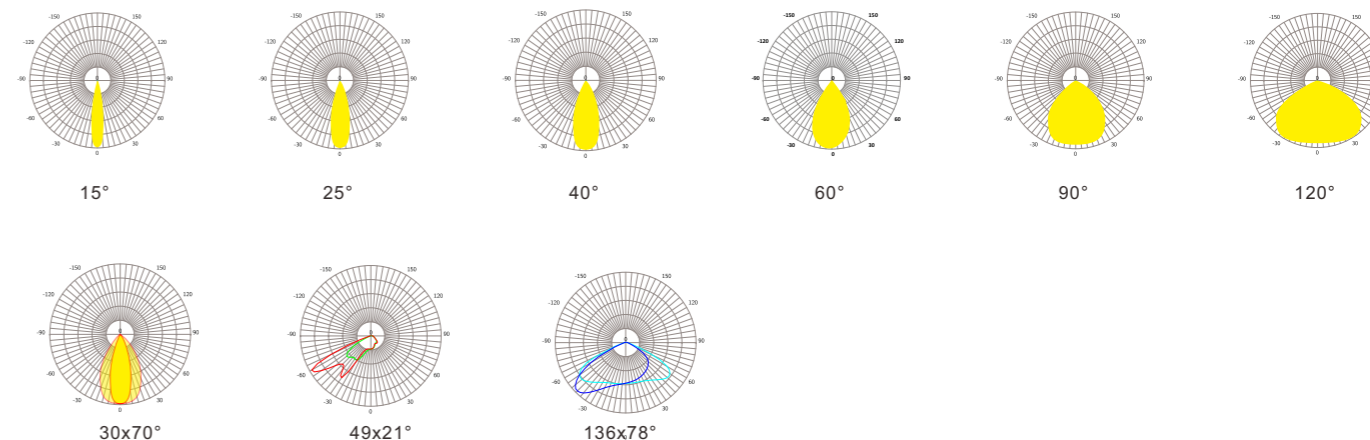

PROE

Folding Aluminum Fin LED Module

140Lm/w 170Lm/w

50W

Folding Aluminum fin design which are very light weight. Increase the heat dissipation surface area by air cooling to dissipate heat and expand the contact area with air! It speeds up the spread of heat! Thermal effect is good!



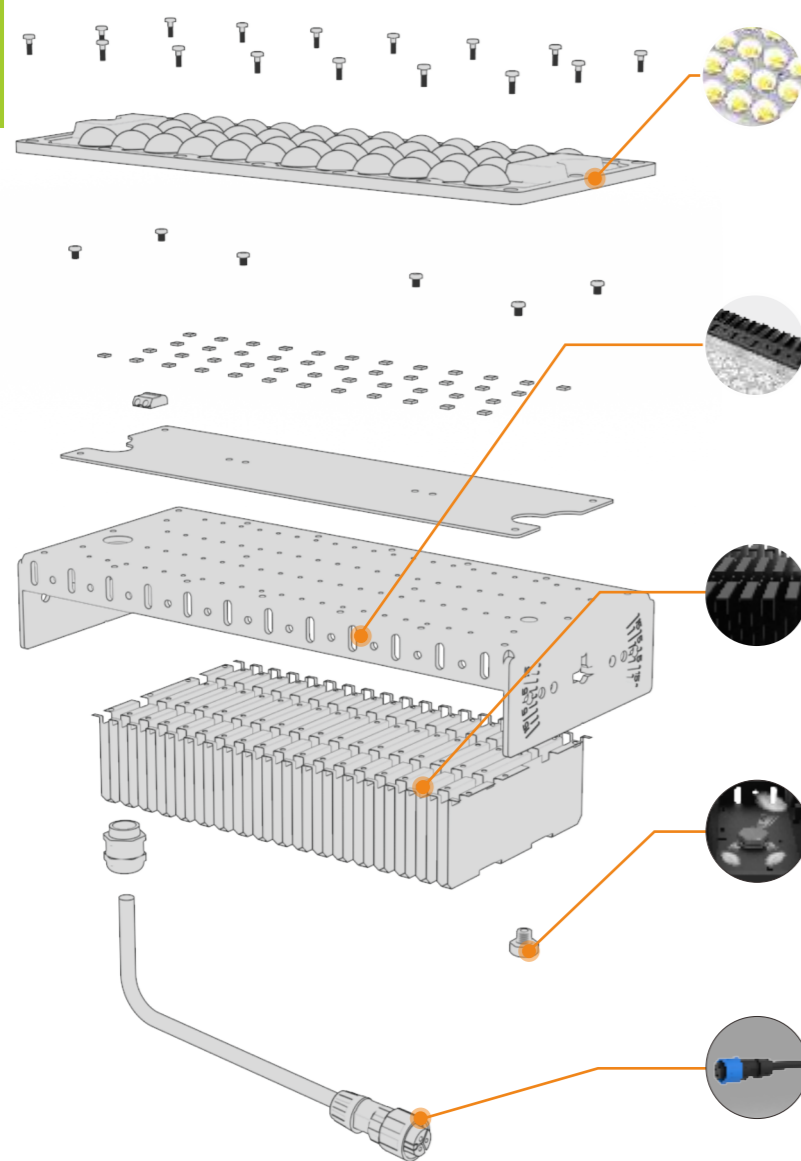

Lens
The optical lens is made of PC, and the Transmittance reaches 92%, reducing light loss, maximize the lumens on where it should be lit up and evenness, minimize lighting pollution to nature and human life.

Aluminum Heat Sink Hemming Design
The module heat sink adopts the hemming design to prevent the deformation of the heat sink due to crash during the shipment and enhance the flatness and strength of the contact surface of the module heat sink.

Pure Aluminum Heat Sink
The modules can be rotated in a chain, which can meet the needs of large area lighting and achieve perfect area lighting

Breathable Protective Air Vent Plug
Each Module of comes with Waterproof Breathable Pressure Relief Vent Plug

M15 Quick Linker
The cable length is exposed 15cm, the default is M15 male plug, it can be customized according to different requirements.



PRO

Folding Aluminum Fin LED Module

160Lm/w 175LM/W

100W 120W

Folding Aluminum fin design which are very light weight. Increase the heat dissipation surface area by air cooling to dissipate heat and expand the contact area with air! It speeds up the spread of heat! Thermal effect is good!



PRO

Folding Aluminum Fin LED Module

- Light Source: Luminleds 5050
- Input Volt: 46-48VDC
- IP Rating IK Rating : IP66 & IK10
- Beam Angle: 10° /20° /40° /60° /90°
P50 P60-L
- Color Temp: 3000K 4000K 5000K 5700K 6000K
- Plug: M15 2Pin Male Plug
- 5 years warranty

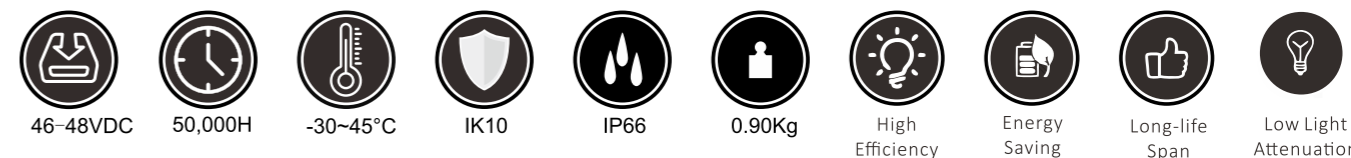
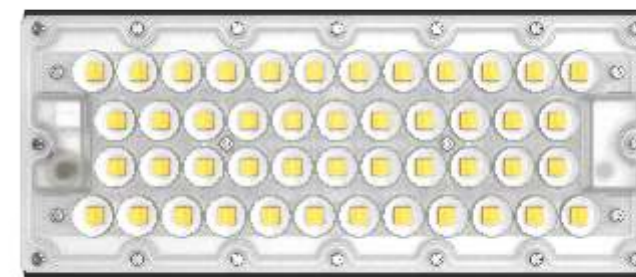

Technical Specifications

Part Number	Watt	Driver	Efficiency	Chip Brand	Lumen	CCT	Net Weight
LSM-100W-PRO	100W	Not included	160LM/W±3%	Luminleds 5050	16,000Lm	3000-6000K	0.9KG
LSM-120W-PRO	120W	Not included	155LM/W±3%	Luminleds 5050	18,600Lm	3000-6000K	0.9KG
LSM-100W-PRO	100W	Not included	175LM/W±3%	Luminleds 5050	17,500Lm	4000-5000K	0.9KG
LSM-120W-PRO	120W	Not included	175LM/W±3%	Luminleds 5050	21,000Lm	4000-5000K	0.9KG

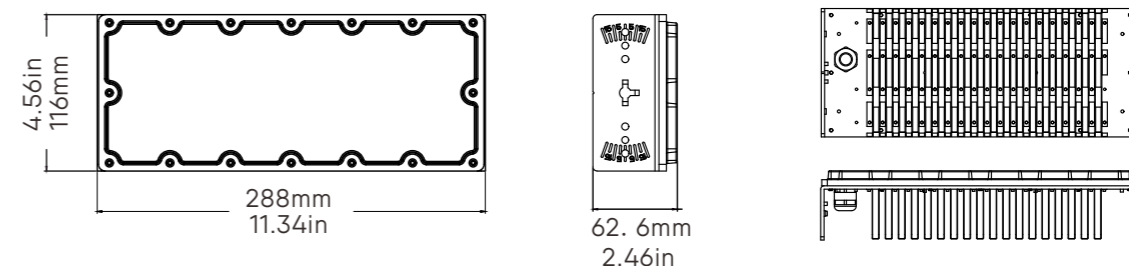

Beam Angle

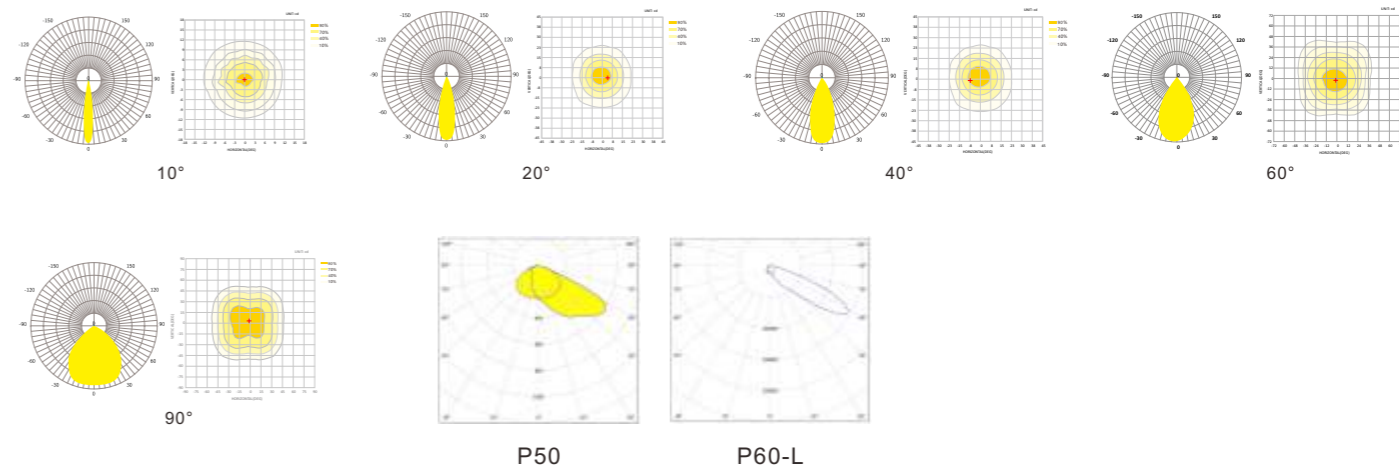

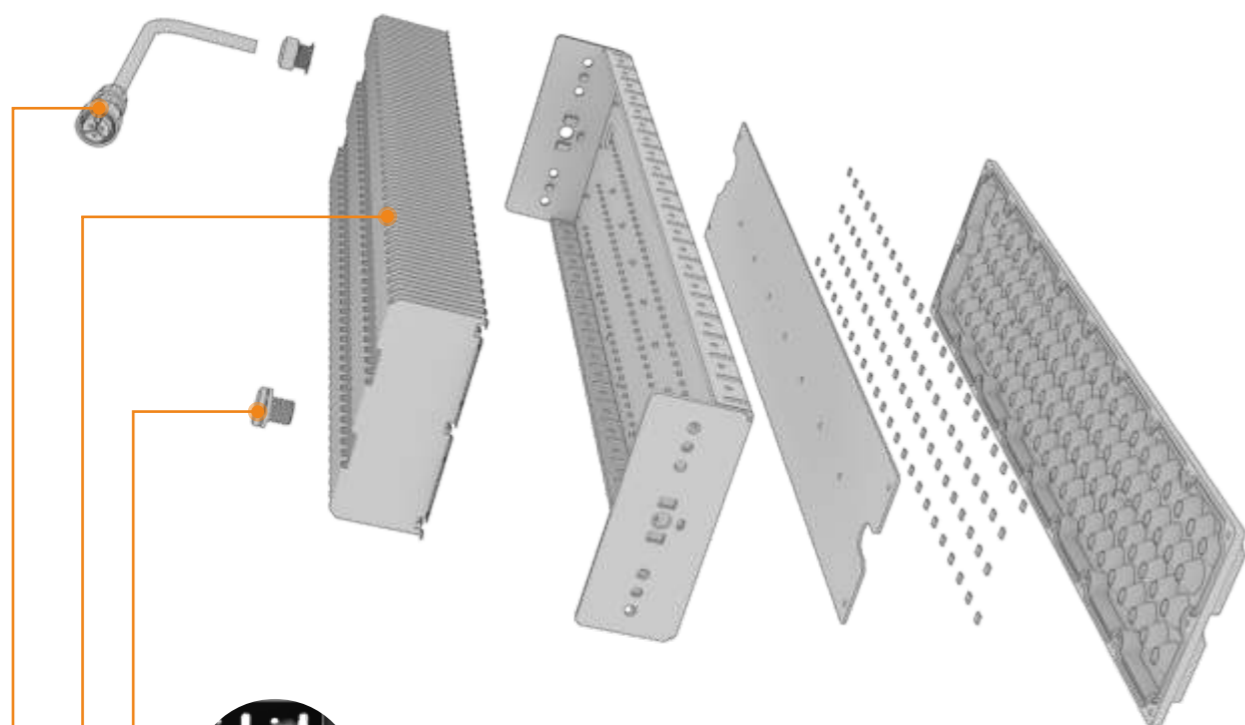

Breathable Protective Air Vent Plug
Each Module of comes with Waterproof Breathable Pressure Relief Vent Plug



Pure aluminum heat sink
The modules can be rotated in a chain, which can meet the needs of large area lighting and achieve perfect area lighting

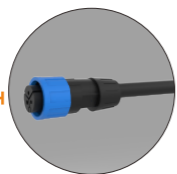

M15 Quick Linker
The cable length is exposed 15cm, the default is M15 male plug, it can be customized according to different requirements.

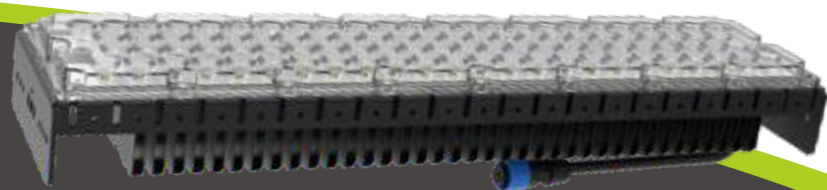

PRO

Folding Aluminum Fin LED Module

175Lm/w 190Lm/w

200W 240W

Folding Aluminum fin design which are very light weight. Increase the heat dissipation surface area by air cooling to dissipate heat and expand the contact area with air! It speeds up the spread of heat! Thermal effect is good!



PRO

Folding Aluminum Fin LED Module

- Light Source: Luminleds 5050 / Osram 5050
- Input Volt: 46-48VDC
- IP Rating IK Rating : IP66 & IK10
- Beam Angle: 10° 20° 40° 60° 90° 30x70° 140x100° 135x60°(P50)
- Color Temp: 3000K - 6000K
- Plug: M15 2Pin Male Plug
- 5 years warranty

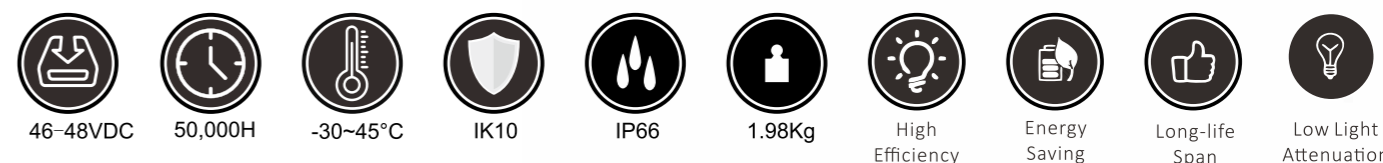

Technical Specifications

Part Number	Watt	Driver	Efficiency	Chip Brand	Lumen	CCT	Net Weight
LSM-200W-PRO	200W	Not included	160LM/W±3%	Luminleds 5050	32,000Lm	3000-6000K	1.98KG
LSM-240W-PRO	240W	Not included	155LM/W±3%	Luminleds 5050	37,200Lm	3000-6000K	1.98KG
LSM-200W-PRO	200W	Not included	175LM/W±3%	Luminleds 5050	35,000Lm	4000-5000K	1.98KG
LSM-240W-PRO	240W	Not included	175LM/W±3%	Luminleds 5050	42,000Lm	4000-5000K	1.98KG

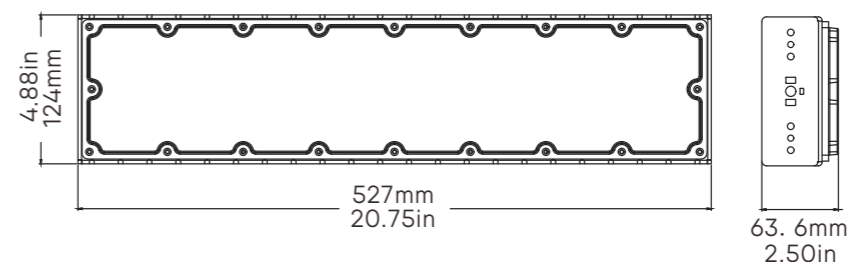

Beam Angle

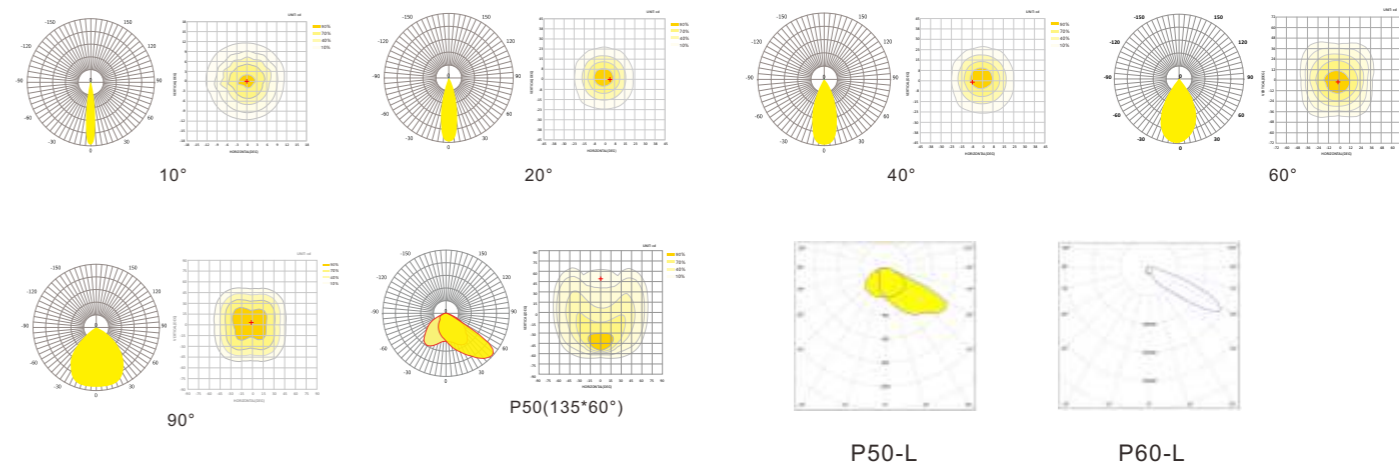

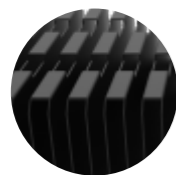
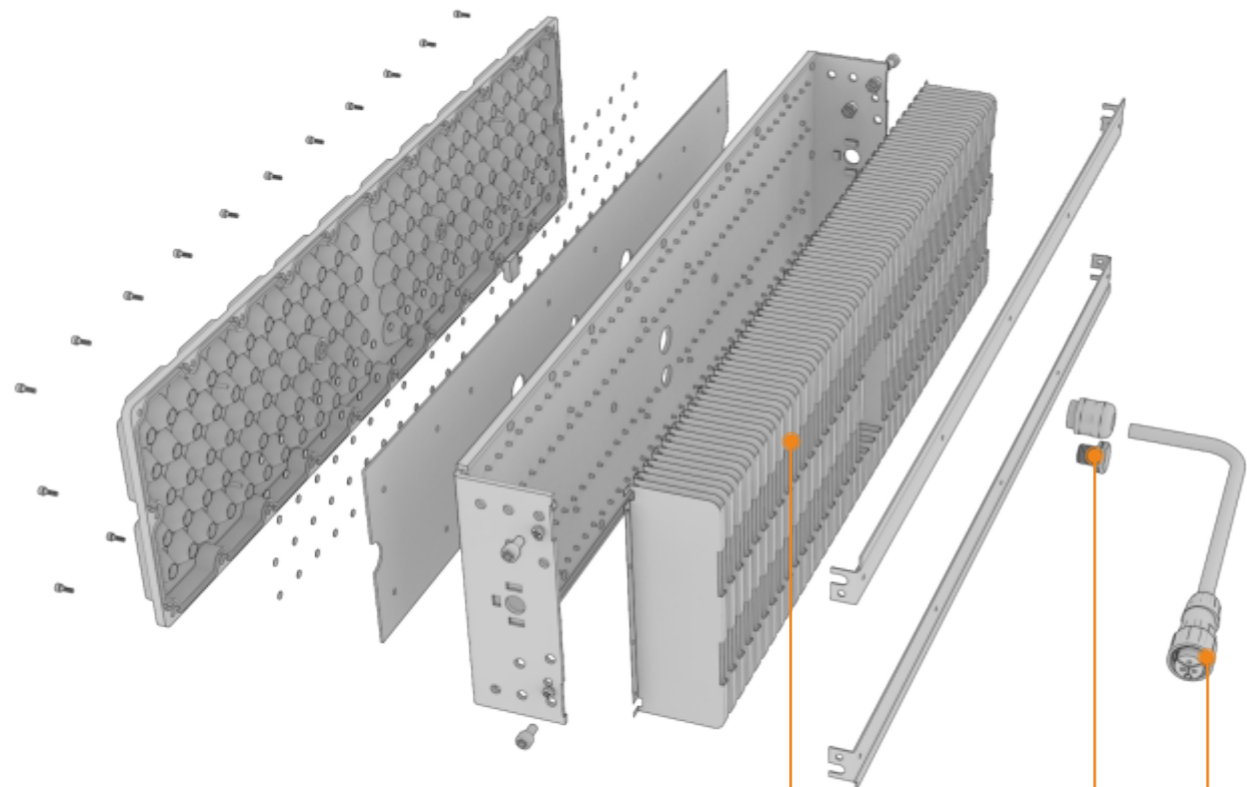

Pure aluminum heat sink

The modules can be rotated in a chain, which can meet the needs of large area lighting and achieve perfect area lighting



Breathable Protective Air Vent Plug

Each Module of comes with Waterproof Breathable Pressure Relief Vent Plug

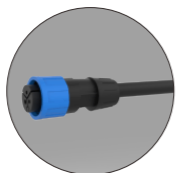

M15 Quick Linker

The cable length is exposed 15cm, the default is M15 male plug, it can be customized according to different requirements.

PLUS

LED FIN MODULE LIGHT

- Light Source: Luminleds 5050 / Osram 5050
- Input Volt: 46-48VDC
- IP Rating IK Rating : IP66 & IK10
- Beam Angle: 10° 20° 40° 60° 140x100° 135x60° (P50)
- Color Temp: 3000K 4000K 5000K 5700K 6000K
- Plug: M15 2Pin Male Plug
- 5 years warranty



--	--	--	--	--	--	--	--	--	--

Technical Specifications

Part Number	Watt	Driver	Efficiency	Chip Brand	Lumen	CCT	Net Weight
LSM-200W-PLUS	200W	Not included	180LM/W±3%	Luminleds 5050	36,000Lm	4000-5000K	2.05KG
LSM-240W-PLUS	240W	Not included	170LM/W±3%	Luminleds 5050	40,800Lm	3000-6000K	2.05KG
LSM-300W-PLUS	300W	Not included	160LM/W±3%	Luminleds 5050	48,000Lm	3000-6000K	2.05KG

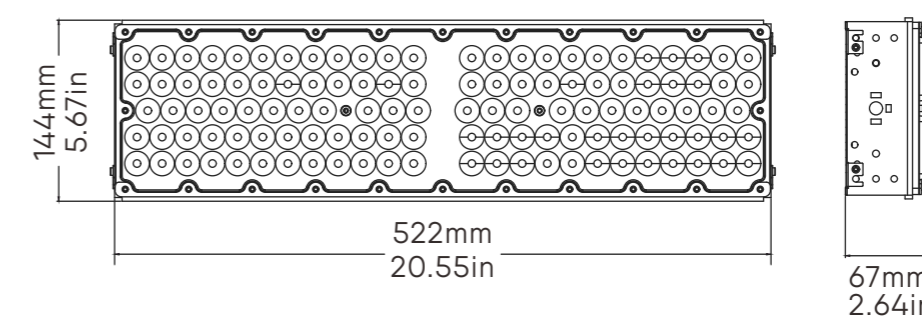

Beam Angle

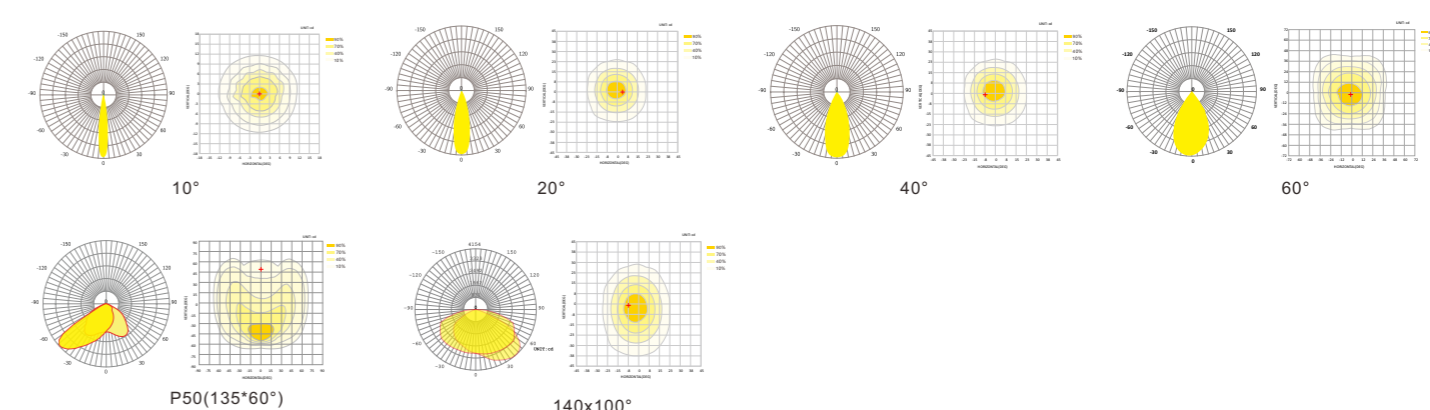

PLUS

Folding Aluminum Fin LED Module

180Lm/w

200W 240W 300W

Folding Aluminum fin design which are very light weight. Increase the heat dissipation surface area by air cooling to dissipate heat and expand the contact area with air! It speeds up the spread of heat! Thermal effect is good!



Light Weight	IP66	IK10
--------------	------	------

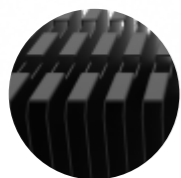
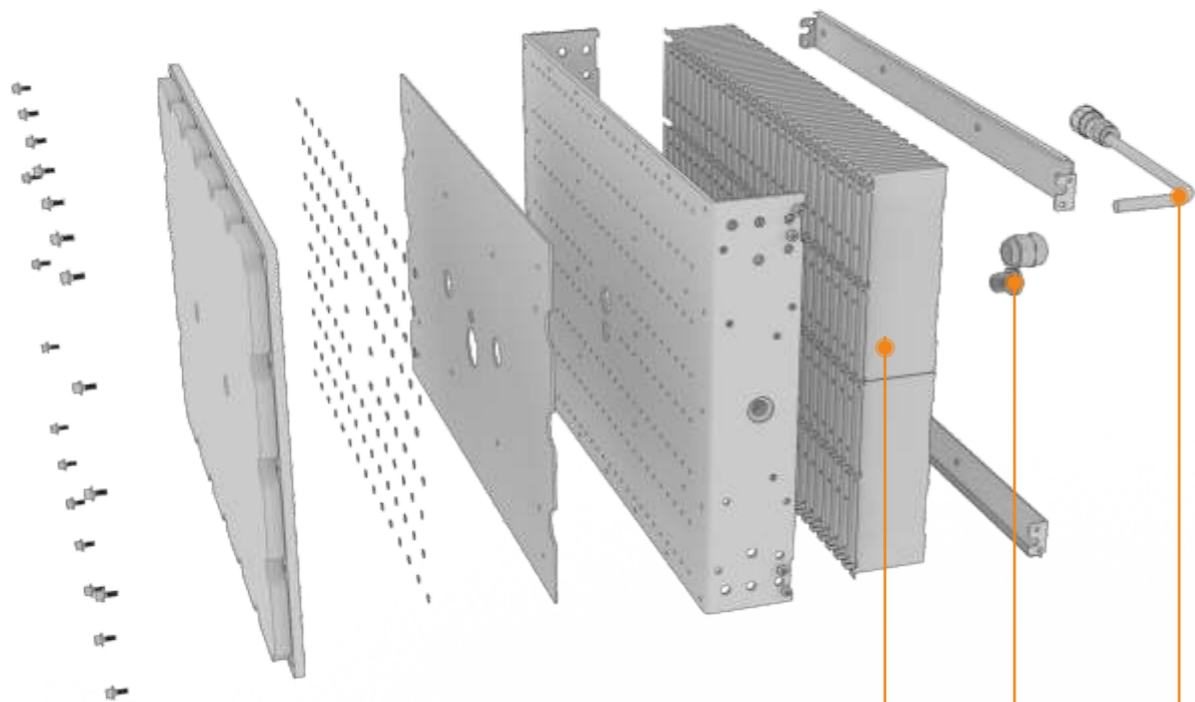

Pure aluminum heat sink

The modules can be rotated in a chain, which can meet the needs of large area lighting and achieve perfect area lighting



Breathable Protective Air Vent Plug

Each Module of comes with Waterproof Breathable Pressure Relief Vent Plug



M15 Quick Linker

The cable length is exposed 15cm, the default is M15 male plug, it can be customized according to different requirements.



MAX

Folding Aluminum Fin SMD 5050 LED Module

170-200Lm/W

240W 300W

Folding Aluminum fin design which are very light weight. Increase the heat dissipation surface area by air cooling to dissipate heat and expand the contact area with air! It speeds up the spread of heat! Thermal effect is good!



MAX

Folding Aluminum Fin LED Module

- Light Source: Luminleds 5050
- Input Volt: 46-48VDC
- IP Rating IK Rating : IP66 & IK10
- Symmetrical Beam Angle: 10° / 20° / 40° / 60°
- Asymmetrical Beam Angle: P50-L / P60-L
- Color Temp: 3000-6000K
- Plug: M15 2Pin Male Plug
- 5 years warranty

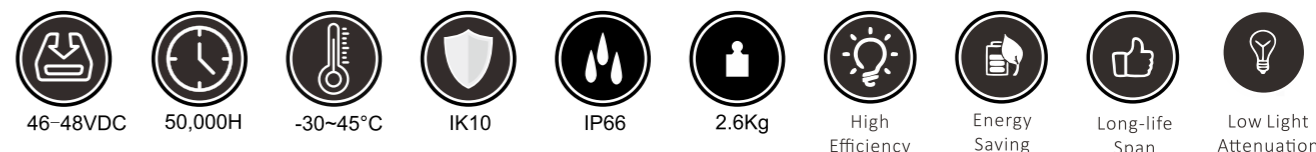

Technical Specifications

Part Number	Watt	Driver	Efficiency	Chip Brand	Lumen	CCT	Net Weight
LSM-240W-MAX	200W	Not included	180lm/w±5%	Luminleds 5050	43,200Lm	4000-5000K	2.6KG
LSM-300W-MAX	300W	Not included	170lm/w±5%	Luminleds 5050	51,000Lm	3000-6000K	2.6KG

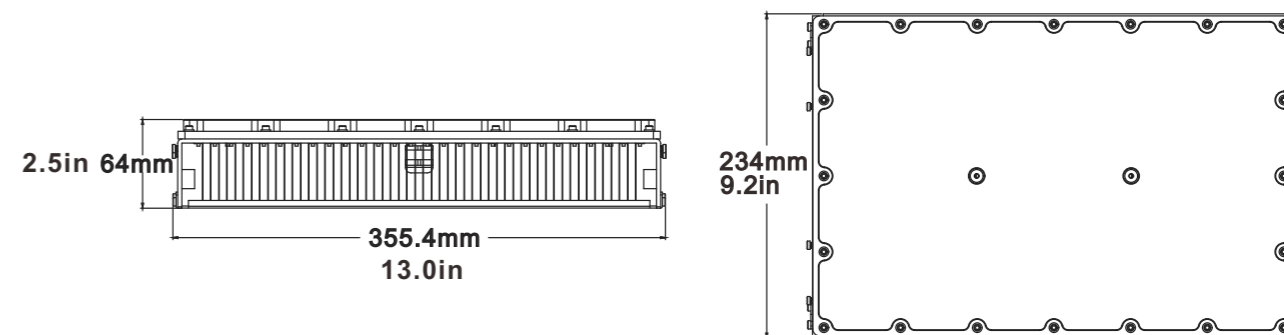

Beam Angle

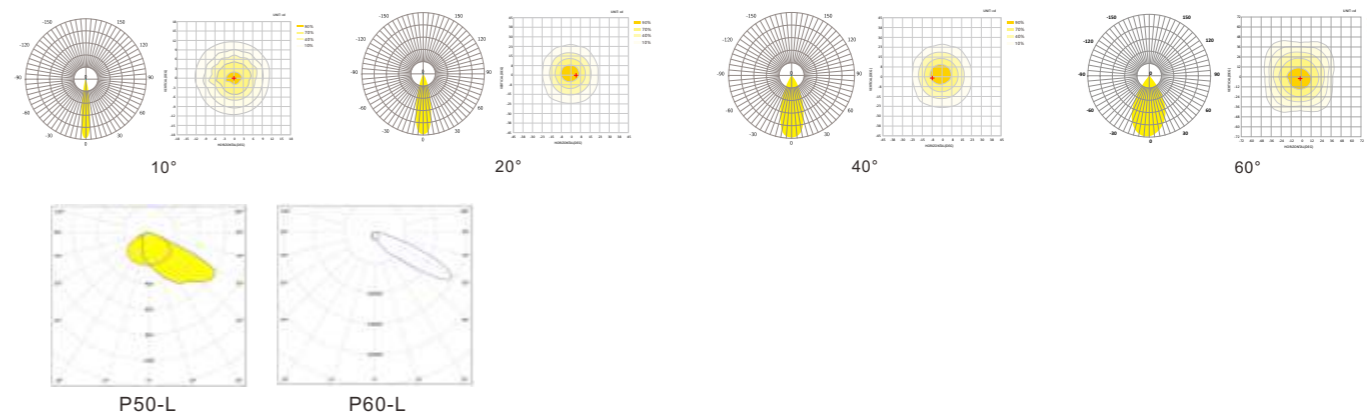

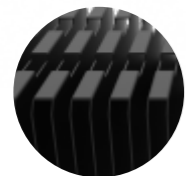
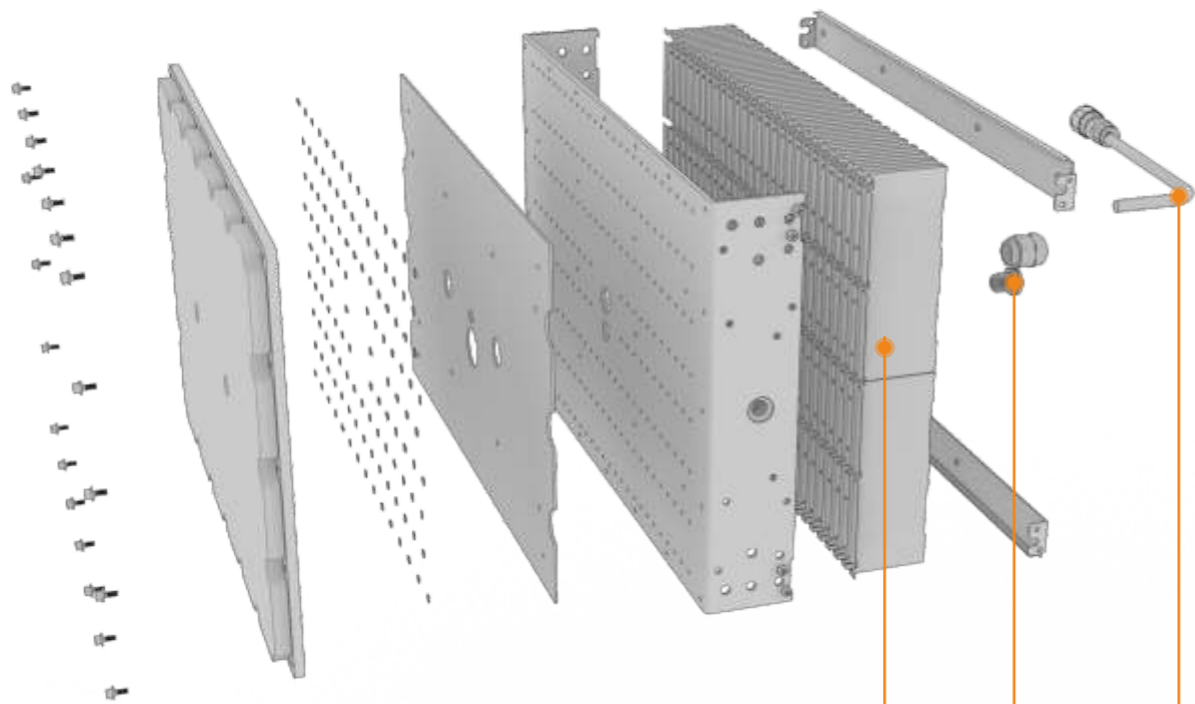

Pure aluminum heat sink

The modules can be rotated in a chain, which can meet the needs of large area lighting and achieve perfect area lighting



Breathable Protective Air Vent Plug

Each Module of comes with Waterproof Breathable Pressure Relief Vent Plug



M15 Quick Linker

The cable length is exposed 15cm, the default is M15 male plug, it can be customized according to different requirements.



Ultra

Folding Aluminum Fin SMD 5050 LED Module

185Lm/w 185Lm/w

500W 600W

Folding Aluminum fin design which are very light weight. Increase the heat dissipation surface area by air cooling to dissipate heat and expand the contact area with air! It speeds up the spread of heat! Thermal effect is good!



Ultra

Folding Aluminum Fin LED Module

- Light Source:Luminleds 5050
- Input Volt: 46-48VDC
- IP Rating IK Rating : IP66 & IK10
- Symmetrical Beam Angle: 10° /20° / 40°/60°
- Asymmetrical Beam Angle: P50-L / P60-L
- Color Temp:3000-6000K
- Plug: M15 2Pin Male Plug
- 5 years warranty

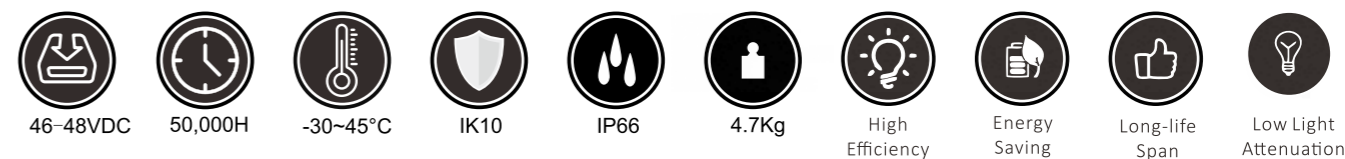

Technical Specifications

Part Number	Watt	Driver	Efficiency	Chip Brand	Lumen	CCT	Net Weight
LSM-500W-Ultra	500W	Not included	185lm/w±5%	Luminleds 5050	92,500Lm	3000~6000K	4.7KG
LSM-600W-Ultra	600W	Not included	180lm/w±5%	Luminleds 5050	108,000Lm	3000~6000K	4.7KG

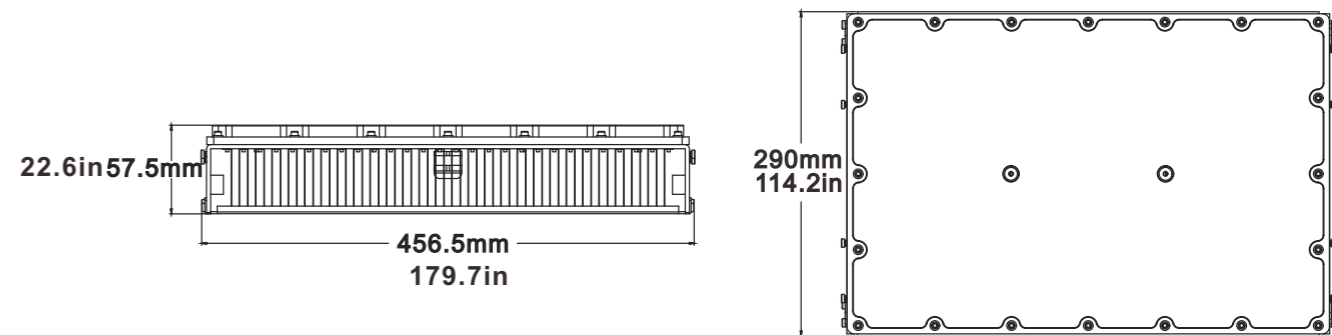

Beam Angle

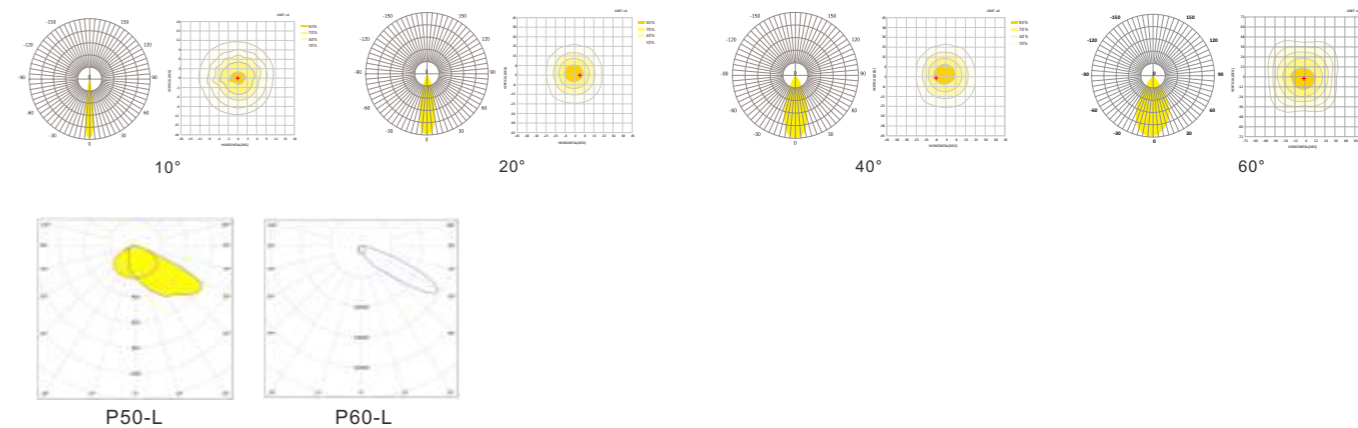

SHOEBOX SERIES AREA LIGHTS| LED PARKING LOT LIGHTS

- Optional photocontrol sensor for dusk to dawn operation
- LED pole light has standard arm mount for square and round poles
- Instant start, no flickering, no humming
- Low profile, corrosion resistant, heavy duty die-cast aluminum housing
- IP65 rated housing
- UV-resistant, multi-layer, architectural color, bronze powder coat finish
- Straight Pole Arm, Round Pole Mount, Slip fitter or Wall Mount.
- 5 years warranty

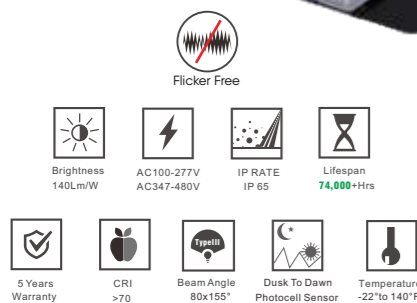

TECHNICAL PARAMETERS

Light Source	Lumileds 5050 / CREE 3030
Power Factor	>0.95
Input Voltage	100-277VAC / 347-480VAC
CCT	3000K/4000K/5000K/5700K/6500K
IP Rating	IP65
Beam Angle	80x155°(Typelll)
Lifetime	74,000+ hours
Certificate	ETL cETL DLC Premium CE RoHS



SPECIFICATIONS INFORMATION

Model	Watt	Input Voltage	Efficiency	Lumen	Driver	Chip Brand
LSSB-100W-LV(XXK)	100W	100-277VAC	130LM/W±3%	13,000Lm	SS-100VA-56	CREE 3030
LSSB-150W-LV(XXK)	150W	100-277VAC	130LM/W±3%	19,500Lm	SS-150VA-56	CREE 3030
LSSB-300W-LV(XXK)	300W	100-277VAC	130LM/W±3%	39,000Lm	2*SS-150VA-56	CREE 3030
LSSB-100W-HV(XXK)	100W	100-277VAC	170LM/W±3%	17,000Lm	SS-100VA-56	Lumileds 5050
LSSB-150W-HV(XXK)	150W	100-277VAC	170LM/W±3%	25,500Lm	SS-150VA-56	Lumileds 5050
LSSB-300W-HV(XXK)	300W	100-277VAC	170LM/W±3%	51,000Lm	2*SS-150VA-56	Lumileds 5050

Model	Watt	Input Voltage	Efficiency	Lumen	Driver	Dimensions (in)
LSSB-100W-LV(XXK)	100W	347-480VAC	140LM/W±3%	14,000Lm	SS-100M-56BH	CREE 3030
LSSB-150W-LV(XXK)	150W	347-480VAC	140LM/W±3%	21,000Lm	SS-150M-56BH	CREE 3030
LSSB-300W-LV(XXK)	300W	347-480VAC	140LM/W±3%	42,000Lm	SS-320M-56BH	CREE 3030
LSSB-100W-HV(XXK)	100W	347-480VAC	170LM/W±3%	17,000Lm	SS-100M-56BH	Lumileds 5050
LSSB-150W-HV(XXK)	150W	347-480VAC	170LM/W±3%	25,500Lm	SS-150M-56BH	Lumileds 5050
LSSB-300W-HV(XXK)	300W	347-480VAC	170LM/W±3%	51,000Lm	SS-320M-56BH	Lumileds 5050

HEXAGON SERIES LED PARKING LOT RETROFIT KITS

- With a big Sunon fan.
- With beam angle 120 degree.
- Original super bright 3030 LED
- Arm adjustable with any beam angle.
- With the most excellent quality meanwell driver.
- Available for street light fixtures application.
- Using aluminum fin heat sink which heat transfer faster than die cast.



TECHNICAL PARAMETERS

Light Source	Lumileds SMD 3030
Power Factor	>0.95
Input Voltage	100-277VAC / 347-480VAC
CCT	3000K/4000K/5000K/5700K/6500K
IP Rating	IP65
Beam Angle	120°
Lifetime	50,000+ hours
Certificate	ETL cETL CE RoHS

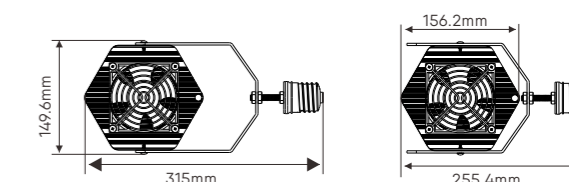
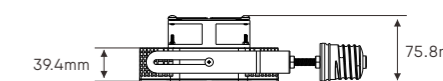
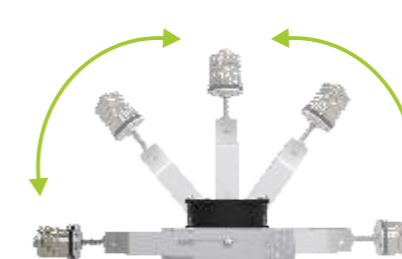
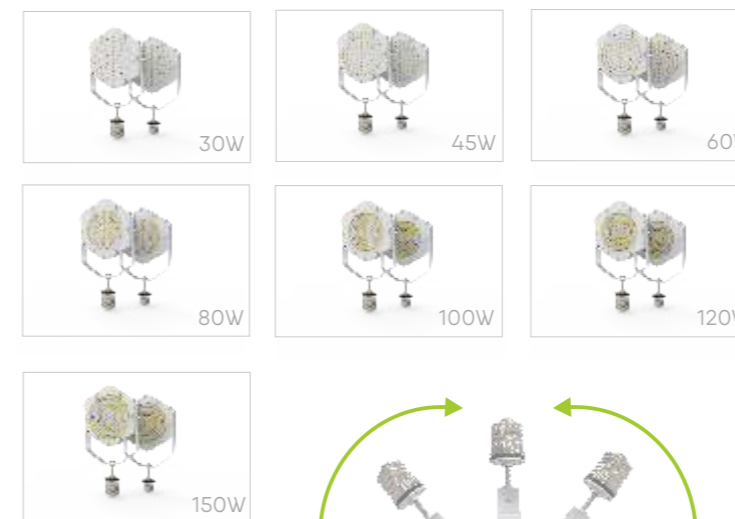

SPECIFICATIONS INFORMATION

Model	Watt	Input Voltage	Efficiency	Lumen	Driver	Replacement
LSRK-30WXY	30W	100-277VAC	130LM/W±3%	4,300Lm	FD-36H-038	75-105W MH HPS
LSRK-45WXY	45W	100-277VAC	130LM/W±3%	6,480Lm	FD-55H-038	105-125W MH HPS
LSRK-60WXY	60W	100-277VAC	130LM/W±3%	8,640Lm	FD-80H-038	150-175W MH HPS
LSRK-80WXY	80W	100-277VAC	130LM/W±3%	11,520Lm	ELG-100-48A	250-275W MH HPS
LSRK-100WXY	100W	100-277VAC	130LM/W±3%	14,400Lm	ELG-100-48A	300-350W MH HPS
LSRK-120WXY	120W	100-277VAC	130LM/W±3%	15,600Lm	ELG-150-48A	350-400W MH HPS
LSRK-150WXY	150W	100-277VAC	130LM/W±3%	21,000Lm	ELG-150-48A	450-500W MH HPS

LED CORN BULBS / LED RETROFIT BULBS



CORN SERIES LED RETROFIT LIGHT BULBS

- Long life span and less brightness degradation.
- Efficiency of power supply is more than 90%.
- No magnetic disturbance influence.
- No UV and near-IR radiation in the light beam.
- Driver is fulfilled with solid thermal grease.
- Free colorful inner box.
- Cooling fan built-in.
- 5 years warranty

TECHNICAL PARAMETERS

Light Source	SMD 2835
Base	E26 E27 E39 E40
Input Voltage	100-277VAC
CCT	3000K/4000K/5000K/5700K/6500K
CRI	>80
Beam Angle	360°
Lifetime	50,000+ hours
Certificate	ETL cETL DLC SAA CE RoHS



SPECIFICATIONS INFORMATION

Model	Watt	Input Voltage	Efficiency	Lumen	Replacement	Dimensions
LSCB-20WXY	20W	100-277VAC	130LM/W±3%	2,500Lm	75W MH HPS	Dia72*175mm
LSCB-30WXY	30W	100-277VAC	130LM/W±3%	3,750Lm	105W MH HPS	Dia72*200mm
LSCB-40WXY	40W	100-277VAC	130LM/W±3%	5,200Lm	125W MH HPS	Dia105*245mm
LSCB-40WXY-S	40W	100-277VAC	130LM/W±3%	5,200Lm	125W MH HPS	Dia105*185mm
LSCB-50WXY	50W	100-277VAC	130LM/W±3%	6,250Lm	150W MH HPS	Dia105*219mm
LSCB-60WXY	60W	100-277VAC	130LM/W±3%	7,800Lm	180W MH HPS	Dia105*255mm
LSCB-70WXY	70W	100-277VAC	130LM/W±3%	9,100Lm	250W MH HPS	Dia105*291mm
LSCB-100WXY	100W	100-277VAC	130LM/W±3%	13,000Lm	300W MH HPS	Dia128*287mm
LSCB-120WXY	120W	100-277VAC	130LM/W±3%	15,600Lm	350W MH HPS	Dia128*307mm
LSCB-150WXY	150W	100-277VAC	130LM/W±3%	19,500Lm	400W MH HPS	Dia128*337mm
LSCB-200WXY	200W	100-277VAC	130LM/W±3%	24,000Lm	500W MH HPS	Dia128*337mm
LSCB-240WXY	240W	100-277VAC	130LM/W±3%	28,000Lm	600W MH HPS	Dia128*357mm

LED CORN BULBS / LED RETROFIT BULBS



CORN SERIES LED RETROFIT LIGHT BULBS

- Long life span and less brightness degradation.
- Efficiency of power supply is more than 90%.
- No magnetic disturbance influence.
- No UV and near-IR radiation in the light beam.
- Driver is fulfilled with solid thermal grease.
- Free colorful inner box.
- Cooling fan built-in.
- 5 years warranty

TECHNICAL PARAMETERS



347-480V

Light Source	SMD 2835
Base	E26 E27 E39 E40
Input Voltage	347-480VAC
CCT	3000K/4000K/5000K/5700K/6500K
CRI	>80
Beam Angle	360°
Lifetime	50,000+ hours
Certificate	ETL cETL DLC SAA CE RoHS



SPECIFICATIONS INFORMATION

Model	Watt	Input Voltage	Efficiency	Lumen	Replacement	Dimensions
LSCB-20WXY	20W	347-480VAC	130LM/W±3%	2,500Lm	75W MH HPS	Dia72*175mm
LSCB-30WXY	30W	347-480VAC	130LM/W±3%	3,750Lm	105W MH HPS	Dia72*200mm
LSCB-40WXY	40W	347-480VAC	130LM/W±3%	5,200Lm	125W MH HPS	Dia105*245mm
LSCB-40WXY-S	40W	347-480VAC	130LM/W±3%	5,200Lm	125W MH HPS	Dia105*185mm
LSCB-50WXY	50W	347-480VAC	130LM/W±3%	6,250Lm	150W MH HPS	Dia105*219mm
LSCB-60WXY	60W	347-480VAC	130LM/W±3%	7,800Lm	180W MH HPS	Dia105*255mm
LSCB-70WXY	70W	347-480VAC	130LM/W±3%	9,100Lm	250W MH HPS	Dia105*291mm
LSCB-100WXY	100W	347-480VAC	130LM/W±3%	13,000Lm	300W MH HPS	Dia128*287mm
LSCB-120WXY	120W	347-480VAC	130LM/W±3%	15,600Lm	350W MH HPS	Dia128*307mm
LSCB-150WXY	150W	347-480VAC	130LM/W±3%	19,500Lm	400W MH HPS	Dia128*337mm
LSCB-200WXY	200W	347-480VAC	130LM/W±3%	24,000Lm	500W MH HPS	Dia128*337mm
LSCB-240WXY	240W	347-480VAC	130LM/W±3%	28,000Lm	600W MH HPS	Dia128*357mm



SKD

SEMI-KNOCK DOWN KIT

SKD Available to Save Maximum Stocks

Easily complete the local manufacturing of finished LED lamps and obtain higher profits.

SKD Solutions

Semi-Knock Down Kit Makes it Easy to Create High-Performing, High-Efficiency.



Simple and quick to assemble



Be friendly to back-up



Faster delivery time to end-user



Locally made is more valuable

- LED SPORTS & STADIUM LIGHT
- LED POST TOP LIGHTS
- LED STREET LIGHTS
- UFO LED HIGH BAY LIGHTS
- LINEAR LED HIGH BAY LIGHTS
- LED FLOODLIGHTS
- LED CONVEYOR LIGHT
- LED SHOEBOX LIGHT FIXTURES
- LED CANOPY LIGHT FIXTURES
- LED RETROFIT KIT
- LED CORN BULBS
- LED WALL PACK LIGHTS
- LED MODULES

Compatible components for fast and easy assembly.

All products in this catalog can be Semi knock down kit



Please visit our website for more detailed information
<https://www.lampshining.com/>
 william@lampshining.com

HOW WE CUSTOMIZE YOUR LED LIGHTS

We will keep you informed of every step and involved in every decision to create a product we know will bring you the most benefits.



1

Customized product requirement



2

Evaluation on the requirement by R & D team



3

Product proposal including quotation and drawing offered in 7 days



4

New product prototype can be provided for confirmation in 7 days



5

Discuss any improvement on the new product prototype



6

Start on new tools trial production mass production which takes around 20-50 days

CUSTOMIZATION

Made your LED lights fit for your own environment and local market not the other way around.



Heat sink housing Design Support

We can manufacture radiator housings in a variety of fabrication methods, allowing you to optimize your costs to complete your project.



Die-casting



Sheet metal



Stamping



Profile extrusion



Cold Forging

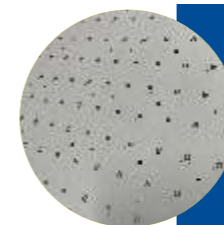

PCB Design Support

If you need specific lighting mode, controlling method or customized shape to fit your project, we provide custom-made PCB design to support.

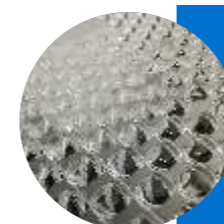

Optical Lens Design Support

If you need specific lighting areas, low glare values and high uniformity for a variety of lighting sites and lighting needs, we offer custom optical design and manufacturing to support.

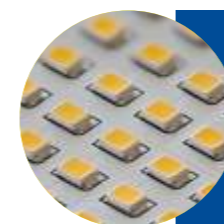

Drive power Design Support

If you need specific power drivers, intelligent controls or custom special voltage power supplies to fit your project, we offer custom drive power supply design and manufacturing to support.



Mounting bracket Design Support

If you need specific luminaire mounting brackets for various mounting environments and special finishes for specific environments, we offer custom mounting bracket design and manufacturing to support.

Lighting Applications

Lighting requirements vary by application. Lampshining Lighting offers lighting solutions that precisely meet the specific needs of the applications.



football field lighting Dragonfly LED High Mast Lights 900w Australian



High-pole area lighting PLUS LED High Mast Light 1500W Portugal



Tennis court lighting NEMO LED Flood Light 300W United Kingdom



High Mast lighting PRO LED HIGH MAST LIGHT 400W Russia



football field lighting PRO LED HIGH MAST LIGHT 240W United Arab Emirates

View All Case Studies
<https://www.lampshining.com/projects/william@lampshining.com>

