

LAMP SHINING

WWW.LAMP SHINING.COM

CONTACT

LAMP SHINING MANUFACTURING CO.,LTD



william@lampshining.com
sales@lampshining.com



0086-13612945445



0086-13612945445



0086-13612945445



lampshining87



www.lampshining.com
www.ledlampshining.com



4th floor Building K Yuanling Zhixuanhan industrial Area Yuanmei communityShiyan Town Bao'an District,Shenzhen China

ABOUT US

Lamp Shining Manufacturing Co.,Ltd was founded in 2010 who has been specializing in developping,manufacturing and selling LED lamps, we have won high reputation from our oversea clients.We have been focusing on the USA ,Europe and Australia markets. We are constantly developing and manufacturing new LED luminaires according to the needs of our customers and the needs of the environment, so we are always in the leading position in the industry.

2021-2022
Products Catalogs

LAMP SHINING

WWW.LAMP SHINING.COM

LAMP SHINING MANUFACTURING CO.,LTD
SHENZHEN LAMP SHINING TECHNOLOGY CO.,LTD

CERTIFICATION

Certification

We have certified DLC, ETL, TUV, SAA, CE, RoHS, ENEC, CB, IECEE, and more than 250 products have received DLC certification. The lighting efficiency is up to 160Lm/W. Suitable for the global lighting market.



EXHIBITION

Hong Kong Spring Lighting Fair



Hong Kong Autumn Lighting Fair



Panama Lighting Fair



SHIPMENT

Shipment



Fast



FAST DELIVERY

Customer satisfaction is our greatest pursuit

We have distributors in the US. Most products are made of semi-materials to meet the delivery time of fast production. We have 3 production lines with over 30 quality controls and workers to meet our fast delivery times and quality. Samples take 1-3 days, and bulk orders take only 10-15 days.

EXHIBITION



2018-2019 INTERNATIONAL LIGHT FAIR



NEW

DRAGONFLY SERIES

LED SPORTS FLOODLIGHT HIGH MAST LIGHT



DRAGONFLY SERIES

LED SPORTS FLOODLIGHT HIGH MAST LIGHT

- Light Source: Lumileds 5050
- Input Volt: 100-277VAC
- modules are 360° rotatable, arm comes with scale plate.
- IK & IP Rating : IK08 Ip66
- Wind rating: 51.0-56.0m/s
- Color Temp: 3000K 4000K 5000K 5700K
- 5 years warranty



LIGHT WEIGHT FLODED FIN

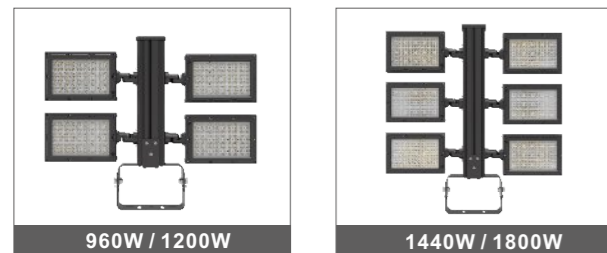
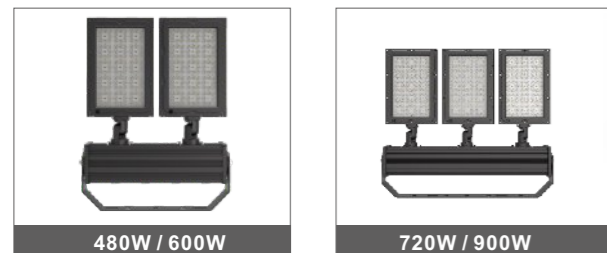
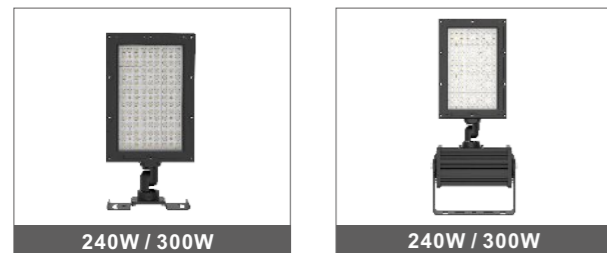

► LIGHT WEIGHT

The advantage of aluminum fin heat dissipation is that the weight is reduced by about 30% to 40%. This is an advantage compared to traditional die-cast aluminum lamps for sports field lighting installations. To reduce the loading weight of the pole and to reduce the workload of the installer.

► FLODED FIN

This allows you to improve thermal performance while adding a minimal amount of weight. Folded Fin heatsinks use a continuous strip of aluminum sheet metal affixed to an aluminum base plate. The advantage of Folded Fin as opposed to extruded heatsinks is higher aspect ratios and thinner fins, thus increasing surface area and lowering thermal resistance. The stamping riveting process is not welded so that it makes the aluminum fins fit more closely with the aluminum board, creating more surface touching area from LED chips heat to the heat sink and contributing to faster heat dissipation.

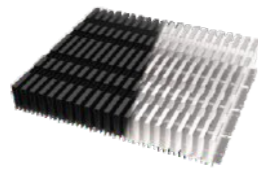

	1 Modules	1 Modules	2 Modules	3 Modules	4 Modules	6 Modules
Part Number	LSDHM-A240W-LV(XXK)	LSDHM-B240W-LV(XXK)	LSDHM-480W-LV(XXK)	LSDHM-720W-LV(XXK)	LSDHM-960W-LV(XXK)	LSDHM-1440W-LV(XXK)
Watt	240W	240W	480W	720W	960W	1440W
Efficiency	165LM/W±3%					
Dimensions (mm)	20.4"x10.61"x5.39"	29.34"x13.1"x6.77"	29.3"x33.37"x6.77"	35.86"x44.31"x7.14"	35.86"x44.31"x7.14"	46.89"x44.31"x7.14"
Lumen	39,600Lm	39,600Lm	79,200Lm	118,800Lm	158,400Lm	237,600Lm
Driver	ELG-240-48A	ELG-240-48A	2*ELG-240-48A	3*ELG-240-48A	4*ELG-240-48A	6*ELG-240-48A
Net weight	6.2Kg	8.9Kg	16.2Kg	22.8Kg	30.4Kg	39.6Kg

	1 Modules	1 Modules	2 Modules	3 Modules	4 Modules	6 Modules
Part Number	LSDHM-A300W-LV(XXK)	LSDHM-B300W-LV(XXK)	LSDHM-600W-LV(XXK)	LSDHM-900W-LV(XXK)	LSDHM-1200W-LV(XXK)	LSDHM-1800W-LV(XXK)
Watt	300W	300W	600W	900W	1200W	1800W
Efficiency	155LM/W±3%					
Dimensions (mm)	20.4"x10.61"x5.39"	29.34"x13.1"x6.77"	29.3"x33.37"x6.77"	35.86"x44.31"x7.14"	35.86"x44.31"x7.14"	46.89"x44.31"x7.14"
Lumen	46,500Lm	46,500Lm	93,000Lm	139,500Lm	186,000Lm	279,000Lm
Driver	ELGC-300-H-A	ELGC-300-H-A	2*ELGC-300-H-A	3*ELGC-300-H-A	4*ELGC-300-H-A	6*ELGC-300-H-A
Net weight	6.6Kg	9.3Kg	18Kg	24Kg	32Kg	42Kg

Beam Angle

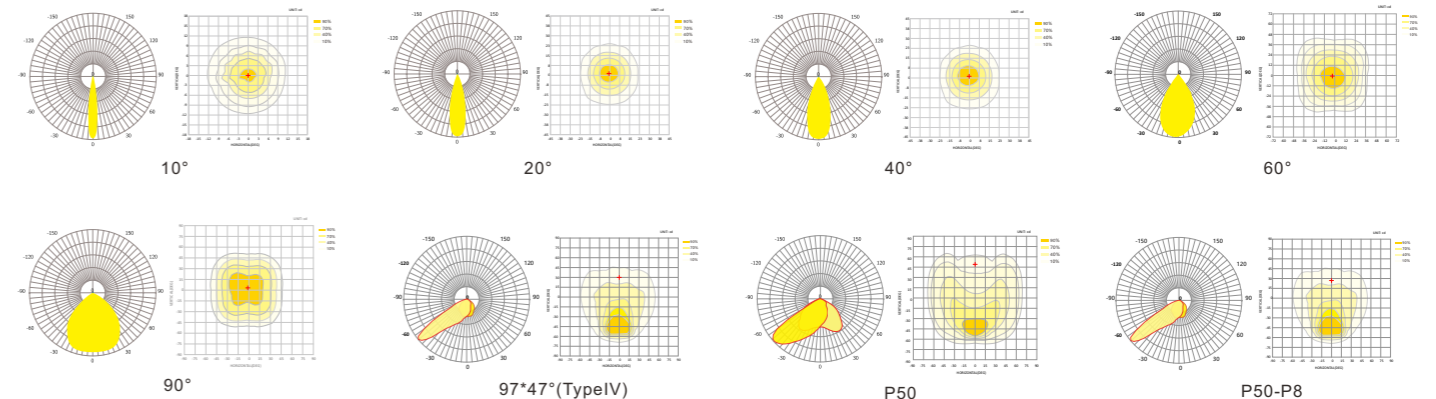

- High Efficiency
- Energy Saving
- Efficient Thermal
- Long-life Span
- Low Light Atenuaaron
- Various Angles

DRAGONFLY PRO SERIES

LED SPORTS FLOODLIGHT HIGH MAST LIGHT

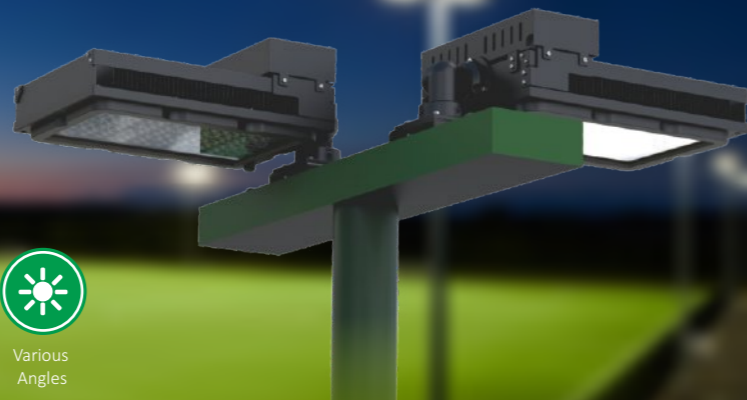

DRAGONFLY SERIES

LED SPORTS FLOODLIGHT HIGH MAST LIGHT

- Light Source: Lumileds 5050
- Input Volt: 100-277VAC or 347-480VAC
- modules are 360° rotatable, arm comes with scale plate.
- IK & IP Rating : IK08 IP66
- Wind rating: 51.0-56.0m/s
- Color Temp: 3000K 4000K 5000K 5700K
- 5 years warranty
- Drivers and modules come with female/male connectors



- 360° Rotatable
- 100-277V
- 50,000H
- Dimmable
- 30-45°C
- IK08
- IP66



Module rotatable 360°

Part Number	LSDHM-A240W-LV(XXK)-SKD	LSDHM-A240W-LV(XXK)-SKD	LSDHM-A300W-LV(XXK)-SKD
Watt	240W	240W	300W
Efficiency	165lm/w±3%	165lm/w±3%	155lm/w±3%
Dimensions (mm)	20.4x10.61x5.39 "	20.4x10.61x5.39 "	20.4x10.61x5.39 "
Lumen	39,600Lm	39,600Lm	46,500Lm
Driver	Meanwell Driver XLG-240-H-A	Meanwell Driver ELG-240-48A	Meanwell Driver ELGC-300-H-A
Net weight	5.6KG	5.8KG	6.2KG

Beam Angle

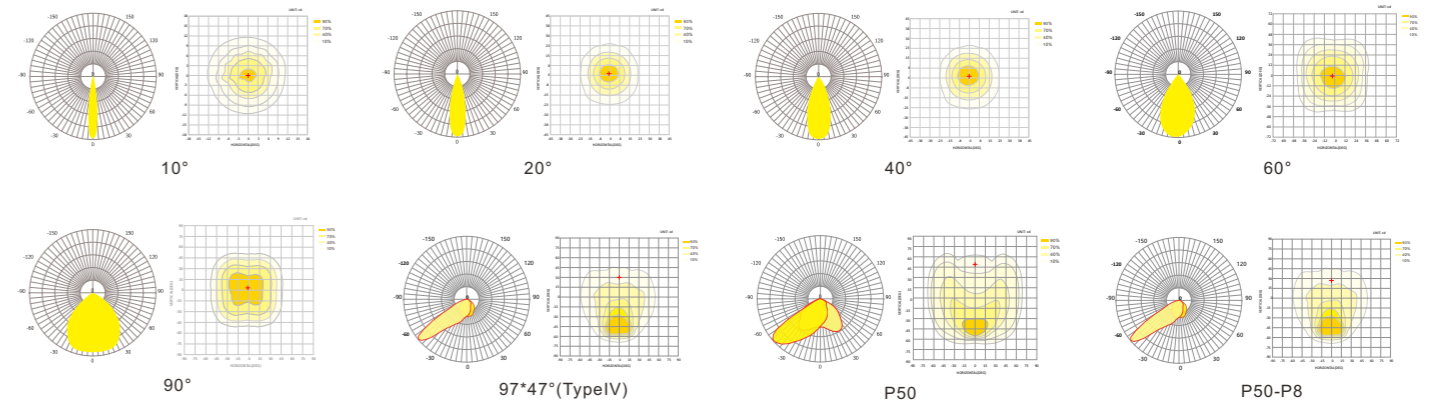

EASY Combination

5 Years Warranty
50000 Hour Long Service Life

1) 600W is assembled by 2pcs 300W, 900W is assembled by 3pcs 300W, 1200W is assembled by 4pcs 300W.

2) You can stock plenty of single modules to assemble them into 2 modules, 3 modules and 4 modules like LEGO by using different installation bracket and cable

X1
+
=

240W Weight: 6. 2kg
300W Weight: 6. 6kg

X2
+
=

480W weight: 12. 4kg
600W weight: 13. 2kg

X3
+
=

480W weight: 12. 4kg
600W weight: 13. 2kg

X4
+
=

960W weight: 24. 8kg
1200W weight: 26. 4kg

- High Efficiency
- Energy Saving
- Efficient Thermal
- Long-life Span
- Low Light Attenuation
- Various Angles

DRAGONFLY PLUS SERIES

LED SPORTS FLOODLIGHT HIGH MAST LIGHT



DRAGONFLY PLUS SERIES

LED SPORTS FLOODLIGHT HIGH MAST LIGHT



- Light Source: Lumileds 5050
- Input Volt: 100-277VAC or 347-480VAC
- modules are 360° rotatable, arm comes with scale plate.
- IK & IP Rating : IK08 IP66
- Wind rating: 51.0-56.0m/s
- Color Temp: 3000K 4000K 5000K 5700K
- 5 years warranty

- 360° Rotatable
- 100-277V
- 50,000H
- Dimmable
- 30~45°C
- IK08
- IP66



EASY Combination

5 Years Warranty
50000 Hour Long Service Life

Quick assembly of modules

To assemble 240W-1800W with 1-6 modules. Modules are packaged separately to reduce shipping costs. AC is connected with M15 waterproof quick connectors. One module can be quickly composed with only 6 screws



Part Number	LSDHM-A240W-LV(XXX)	LSDHM-A240W-LV(XXX)	LSDHM-A300W-LV(XXX)
Watt	240W	240W	300W
Efficiency	165lm/w±3%	165lm/w±3%	155lm/w±3%
Dimensions (mm)	438x390x281mm	438x390x281mm	438x390x281mm
Lumen	39,600Lm	39,600Lm	46,500Lm
Driver	Meanwell Driver XLG-240-H-A	Meanwell Driver ELG-240-48A	Meanwell Driver ELGC-300-H-A
Net weight	9.5KG	9.5KG	10KG

Beam Angle



DRAGONFLY MAX

LED HIGH MAST FLOOD LIGHTING

Features



Light Weight

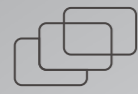

Modular



10KV 20KV



51.0-56.0m/s
Wind load



IP66



IK10



Visor

Reducing glare and upward light



Module fixing buckle

The fixed buckle of the module is made of stainless steel and the left and right direction of the module can be adjusted by $\pm 45^\circ$



Breathable Protective Air Vent Plug

Each Module of comes with Waterproof Breathable Pressure Relief Vent Plug

Tool-free for adjustment

Knob fixing which is for tool-free adjustment of module angle $\pm 45^\circ$

Pure aluminum heat sink

pure aluminum body with strong anticorrosion performance and excellent heat dissipation ability.

Driver box is separable

The module is separated from the driver, and the driver box can be installed separately under the light pole for easy maintenance in the future days. Drivers and modules come with female/male connectors

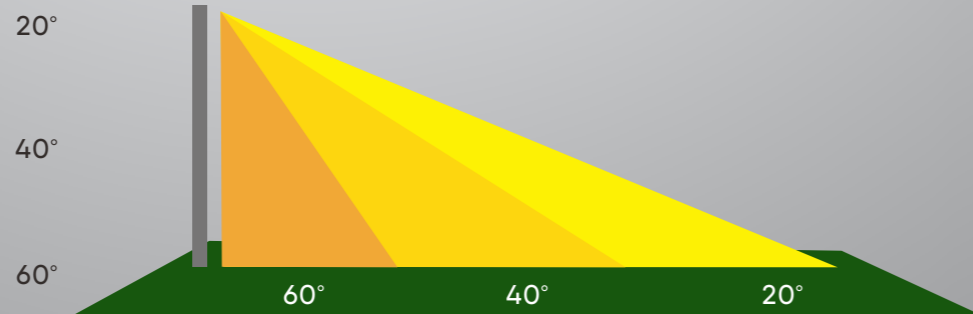
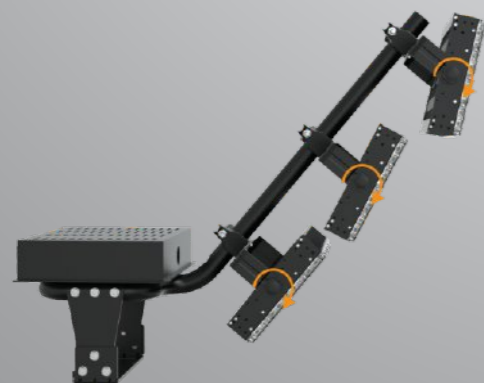

DRAGONFLY MAX

LED HIGH MAST LIGHTS



- Light Source: Lumileds 5050 / Osram 5050
- Input Volt: 100-277VAC / 347-480VAC
- IP & IK Rating : IP66 & IK10
- Dimmable: 1-10V
- SPD: 10KV / 20KV
- Beam Angle: 20° 40° 60°
- Color Temp: 3000K 4000K 5000K 5700K 6000K
- 5 years warranty



FLAME RETARDED



SALT SPRAY TEST



100-277V



347-480V



Dimmable



50,000H



Adjust



-30~45°C



IK10



IP66



Folding Aluminum Fin

Model	Watt	Efficiency	Lumen	Driver	Size (L x W x H)	Weight
LSDHM-240W-LV(XXK)MAX	240W	180lm/w $\pm 3\%$	43,200Lm	XLG-240-H-A	381.5x300x120mm	4.2Kg
LSDHM-300W-LV(XXK)MAX	300W	170lm/w $\pm 3\%$	51,000Lm	ELGC-300-H-A	381.5x300x120mm	4.2Kg
LSDHM-480W-LV(XXK)MAX	480W	180lm/w $\pm 3\%$	86,400Lm	2 x ELG-240-48A	420x787x540mm	14.5KG
LSDHM-600W-LV(XXK)MAX	600W	170lm/w $\pm 3\%$	102,000Lm	2 x ELGC-300-H-A	420x787x540mm	15KG
LSDHM-720W-LV(XXK)MAX	720W	180lm/w $\pm 3\%$	129,600Lm	3 x ELG-240-48A	420x960x754.5mm	19.5KG
LSDHM-900W-LV(XXK)MAX	900W	170lm/w $\pm 3\%$	153,000Lm	3 x ELGC-300-H-A	420x960x754.5mm	20.5KG
LSDHM-960W-LV(XXK)MAX	960W	180lm/w $\pm 3\%$	172,800Lm	4 x ELG-240-48A	818.5x788x555mm	25.5KG
LSDHM-1200W-LV(XXK)MAX	1200W	170lm/w $\pm 3\%$	204,000Lm	4 x ELGC-300-H-A	818.5x788x555mm	26.5KG
LSDHM-1440W-LV(XXK)MAX	1440W	180lm/w $\pm 3\%$	259,200Lm	6 x ELG-240-48A	818.5x962x785mm	34.5KG
LSDHM-1800W-LV(XXK)MAX	1800W	170lm/w $\pm 3\%$	306,000Lm	6 x ELGC-300-H-A	818.5x962x785mm	36.5KG

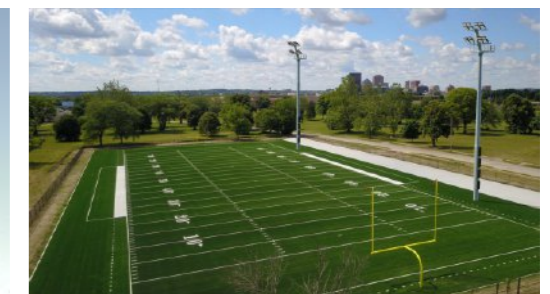

Beam Angle

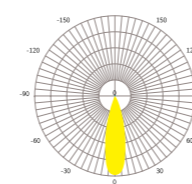

20°

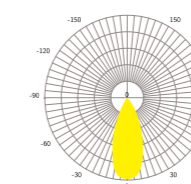

40°

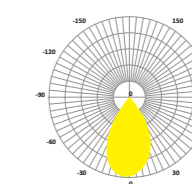

60°



SLIM PRO

LED HIGH MAST LIGHT 100W-1440W

5 Years Warranty
50000 Hour Long Service Life

SLIM PRO SERIES

LED HIGH MAST LIGHT & Flood Light

- Light Source: Lumileds 5050
- Input Volt: 100-277VAC / 374-480V
- Module rotatable 270°
- IK & IP RATING : IK10 IP66
- Housing: Marine grade aluminum
- Color Temp: 3000K 4000K 5000K 5700K
- 5 years warranty

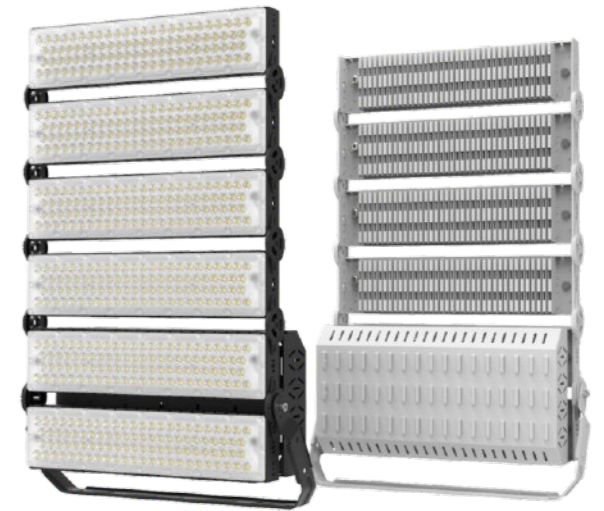

FLAME RETARDED

SALT SPRAY TEST

100-277V

347-480V

Dimmable

50,000H

Adjust

-30~45°C

IK10

IP66

Folding Aluminum Fin

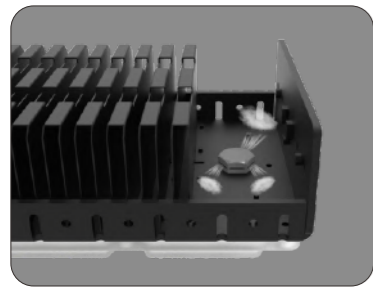

M20 Waterproof Breathable Pressure Relief Vent Plug

SILM PRO SERIES

SILM PRO series LED HIGH MAST LIGHT is built with robust Folding aluminum fin module housing and heavy duty anticorrosive surface treatment for sparking the beauty and improving lighting conditions of applied area. Originated by the demand for large field lighting applications, SILM PRO series flood lights can be extended to 1440W and fixture efficacy reaches to 160LPW, better brilliance, less energy consumption.

Folding aluminum fin design

Folding aluminum fin design which are very light weight. Increase the heat dissipation surface area by air cooling to dissipate heat and expand the contact area with air! It speeds up the spread of heat! Thermal effect is good! Compared with traditional die-cast aluminum and profile aluminum, which is heavier and there are certain safety risks. On the contrary, the aluminum fin heat sink are more secure.

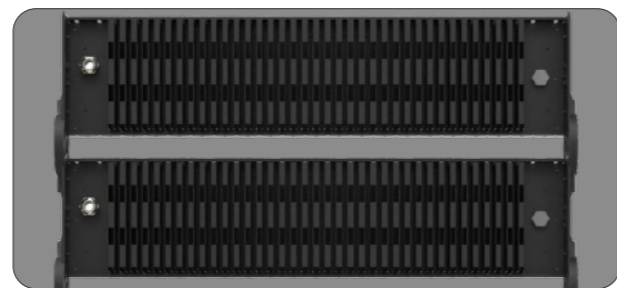

Model	Watt	Efficiency	Lumen	Chip Brand	Dimensions (mm)	Weight
LSHM-100W-LV(XXX)	100W	160LM/W±3%	16,000Lm	Luminleds 5050	297*263*132mm	2.2Kg
LSHM-120W-LV(XXX)	120W	155LM/W±3%	18,600Lm	Luminleds 5050	297*263*132mm	2.2Kg
LSHM-200W-LV(XXX)	200W	160LM/W±3%	32,000Lm	Luminleds 5050	342*362*132mm	5.5Kg
LSHM-240W-LV(XXX)	240W	155LM/W±3%	37,200Lm	Luminleds 5050	342*362*132mm	5.5Kg
LSHM-300W-LV(XXX)	300W	160LM/W±3%	48,000Lm	Luminleds 5050	475*362*132mm	7.5Kg
LSHM-400W-LV(XXX)	400W	160LM/W±3%	64,000Lm	Luminleds 5050	597*362*132mm	10.0Kg
LSHM-480W-LV(XXX)	480W	155LM/W±3%	74,400Lm	Luminleds 5050	597*362*132mm	10.0Kg
LSHM-B400W-LV(XXX)	400W	160LM/W±3%	64,000Lm	Luminleds 5050	529*362*132mm	13.2Kg
LSHM-B480W-LV(XXX)	480W	155LM/W±3%	74,400Lm	Luminleds 5050	529*362*132mm	13.2Kg
LSHM-B600W-LV(XXX)	600W	160LM/W±3%	96,000Lm	Luminleds 5050	649*375*132mm	12.5Kg
LSHM-B720W-LV(XXX)	720W	155LM/W±3%	111,600Lm	Luminleds 5050	649*375*132mm	12.5Kg
LSHM-B800W-LV(XXX)	800W	160LM/W±3%	128,000Lm	Luminleds 5050	650*597*132mm	16Kg
LSHM-B960W-LV(XXX)	960W	155LM/W±3%	148,000Lm	Luminleds 5050	650*597*132mm	16Kg
LSHM-B1000W-LV(XXX)	1000W	160LM/W±3%	160,000Lm	Luminleds 5050	729*650*132mm	20Kg
LSHM-B1200W-LV(XXX)	1200W	155LM/W±3%	186,600Lm	Luminleds 5050	729*650*132mm	20Kg
LSHM-B1440W-LV(XXX)	1440W	155LM/W±3%	223,200Lm	Luminleds 5050	860*650*132mm	22Kg

Beam Angle

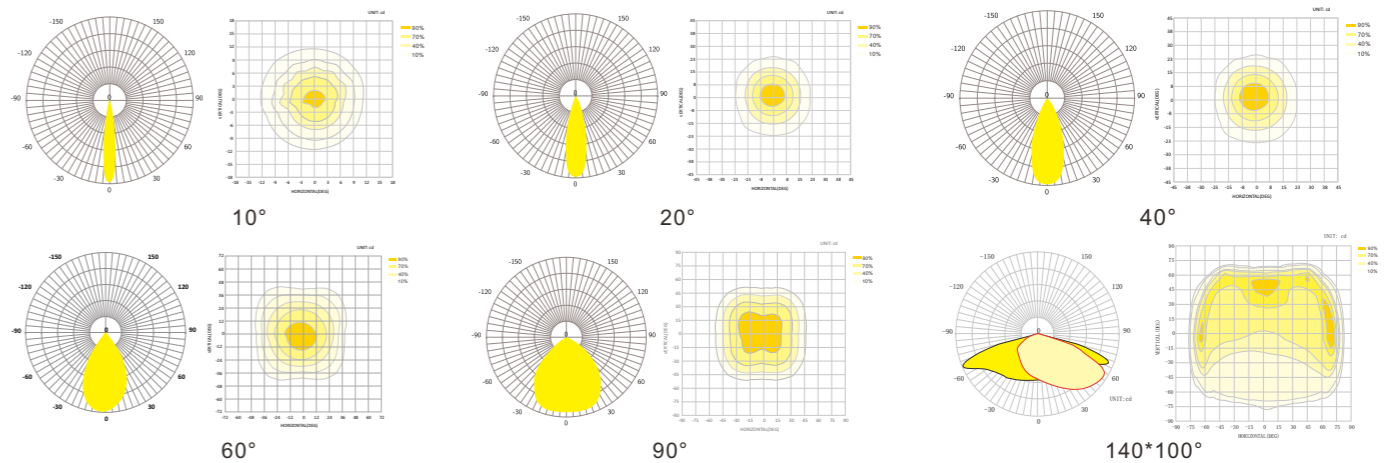

- All Applications**

 - Uniformity and light quality
 - Light pollution and spillage
 - Controls

Baseball, Softball

 - High levels of illumination
 - Lighted from all sides
 - Reducing glare

Harbors, Wharfs

 - Pole location (primarily sidelines)
 - Pole quantity
 - Number of fixtures per pole

Soccer, Lacrosse, Mixed Use

 - Pole location
 - Pole quantity
 - Number of fixtures per pole

Basketball, Tennis

 - Floodlight, or area-style fixtures
 - Court configuration (grouping)
 - Court access



PRO X

LED HIGH MAST FLOOD LIGHTING

Features



Light Weight



Modules can rotate continuously



10KV 20KV



51.0-56.0m/s
Wind load



IP66



IK10



Visor

Reducing glare and upward light

PRO X

LED HIGH MAST LIGHTS



- Light Source: Lumileds 5050 / Osram 5050
- Input Volt: 100-277VAC / 347-480VAC
- IP & IK Rating : IP66 & IK10
- Dimmable: 1-10V
- SPD: 10KV / 20KV
- Beam Angle: 10° 20° 40° 60° 90° 140x100° 135x60° (P50) 70x30°
- Color Temp: 3000K 4000K 5000K 5700K 6000K
- 5 years warranty



100-277V



347-480V



Dimmable



50,000H



Adjust



-30~45°C



IK10



IP66



Folding Aluminum Fin



FLAME RETARDED



SALT SPRAY TEST

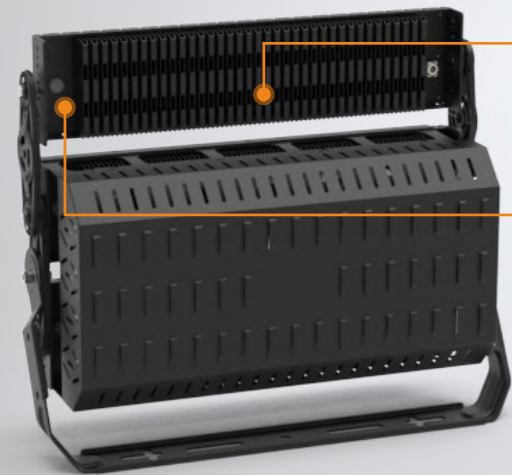

Pure aluminum heat sink

pure aluminum body with strong anticorrosion performance and excellent heat dissipation ability.



Breathable Protective Air Vent Plug

Each Module of comes with Waterproof Breathable Pressure Relief Vent Plug

Pure aluminum heat sink

The modules can be rotated in a chain, which can meet the needs of large area lighting and achieve perfect area lighting



Model	Watt	Efficiency	Lumen	Chip Brand	Size (L*W*H)	Weight
LSHM-200W-LV(XXX)ProX	200W	160LM/W±3%	32,000Lm	Luminleds 5050	342x362x132mm	5.5kg
LSHM-240W-LV(XXX)ProX	240W	155LM/W±3%	37,200Lm	Luminleds 5050	342x362x132mm	5.5kg
LSHM-300W-LV(XXX)ProX	300W	160LM/W±3%	48,000Lm	Luminleds 5050	475x362x132mm	7.5kg
LSHM-400W-LV(XXX)ProX	400W	160LM/W±3%	64,000Lm	Luminleds 5050	597x362x132mm	10kg
LSHM-480W-LV(XXX)ProX	480W	155LM/W±3%	74,400Lm	Luminleds 5050	597x362x132mm	10kg
LSHM-B400W-LV(XXX)ProX	400W	160LM/W±3%	64,000Lm	Luminleds 5050	529x362x188mm	10kg
LSHM-B480W-LV(XXX)ProX	480W	160LM/W±3%	76,800Lm	Luminleds 5050	529x362x188mm	10kg
LSHM-B600W-LV(XXX)ProX	600W	160LM/W±3%	96,000Lm	Luminleds 5050	649x375x188mm	12.5kg
LSHM-B720W-LV(XXX)ProX	720W	160LM/W±3%	115,200Lm	Luminleds 5050	649x375x188mm	12.5kg
LSHM-B800W-LV(XXX)ProX	800W	160LM/W±3%	128,000Lm	Luminleds 5050	650x597x188mm	16kg
LSHM-B960W-LV(XXX)ProX	960W	160LM/W±3%	153,600Lm	Luminleds 5050	650x597x188mm	16kg
LSHM-B1000W-LV(XXX)ProX	1000W	160LM/W±3%	160,000Lm	Luminleds 5050	729x650x188mm	20kg
LSHM-B1200W-LV(XXX)ProX	1200W	160LM/W±3%	192,000Lm	Luminleds 5050	729x650x188mm	20kg
LSHM-B1440W-LV(XXX)ProX	1440W	160LM/W±3%	230,400Lm	Luminleds 5050	860x650x188mm	22kg

Beam Angle

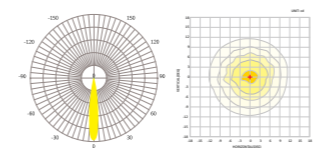

10°

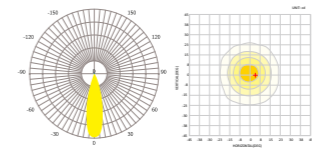

20°

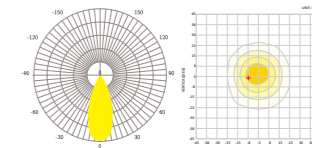

40°

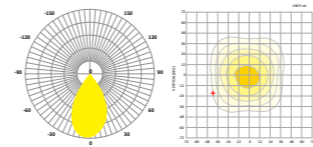

60°

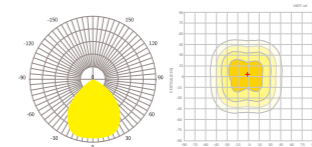

90°

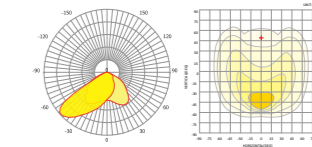

P50(135°60°)

NEW

SLIM PLUS SERIES

LED HIGH MAST LIGHT & Flood Light

- Light Source: Lumileds 5050
- Input Volt: 100-277VAC / 374-480V
- Module rotatable 270°
- IK & IP RATING : IK10 IP66
- Housing: Marine grade aluminum
- Color Temp: 3000K 4000K 5000K 5700K
- 5 years warranty



SLIM PLUS

LED HIGH MAST LIGHT 240W-1500W

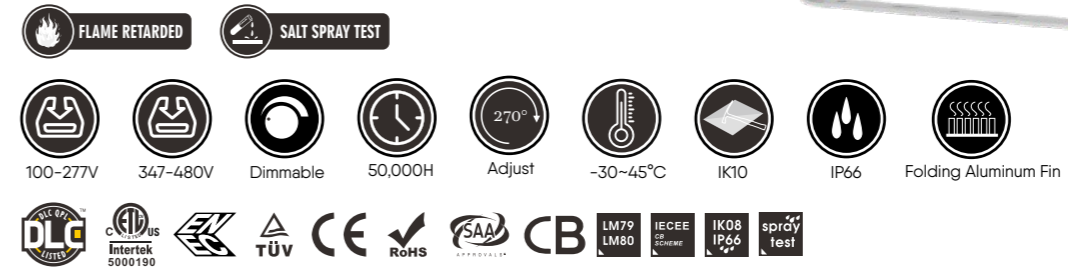

Professional high mast light is required more and more for applications where not only lux on ground is asked, but also homogeneity, small beam angle multiple, lifetime, resistance are even more important. "Slim pro" is the ideal solution.

180
LM/W



Model	Watt	Efficiency	Lumen	Chip Brand	Dimensions (mm)	Weight
LSHM-200W-LV(XXK)PLUS	200W	180LM/W±3%	36,000Lm	Luminleds 5050	565*308*155mm	7.0Kg
LSHM-240W-LV(XXK)PLUS	240W	170LM/W±3%	40,800Lm	Luminleds 5050	565*308*155mm	7.0Kg
LSHM-300W-LV(XXK)PLUS	300W	160LM/W±3%	48,000Lm	Luminleds 5050	565*308*155mm	7.5Kg
LSHM-400W-LV(XXK)PLUS	400W	180LM/W±3%	72,000Lm	Luminleds 5050	565*382*155mm	10Kg
LSHM-480W-LV(XXK)PLUS	480W	170LM/W±3%	81,600Lm	Luminleds 5050	565*382*155mm	10Kg
LSHM-600W-LV(XXK)PLUS	600W	160LM/W±3%	96,000Lm	Luminleds 5050	565*382*155mm	11Kg
LSHM-600W-LV(XXK)PLUS-B	600W	180LM/W±3%	144,000Lm	Luminleds 5050	565*434*155mm	13Kg
LSHM-720W-LV(XXK)PLUS	720W	170LM/W±3%	122,400Lm	Luminleds 5050	565*434*155mm	13Kg
LSHM-900W-LV(XXK)PLUS	900W	160LM/W±3%	144,000Lm	Luminleds 5050	565*434*155mm	14.5Kg
LSHM-800W-LV(XXK)PLUS	800W	180LM/W±3%	144,000Lm	Luminleds 5050	565*582*155mm	16Kg
LSHM-960W-LV(XXK)PLUS	960W	170LM/W±3%	163,200Lm	Luminleds 5050	565*582*155mm	16Kg
LSHM-1200W-LV(XXK)PLUS	1200W	160LM/W±3%	192,000Lm	Luminleds 5050	565*582*155mm	18Kg
LSHM-1000W-LV(XXK)PLUS	1000W	180LM/W±3%	180,000Lm	Luminleds 5050	565*730*155mm	20Kg
LSHM-1500W-LV(XXK)PLUS	1500W	160LM/W±3%	240,000Lm	Luminleds 5050	565*730*155mm	22Kg

Beam Angle

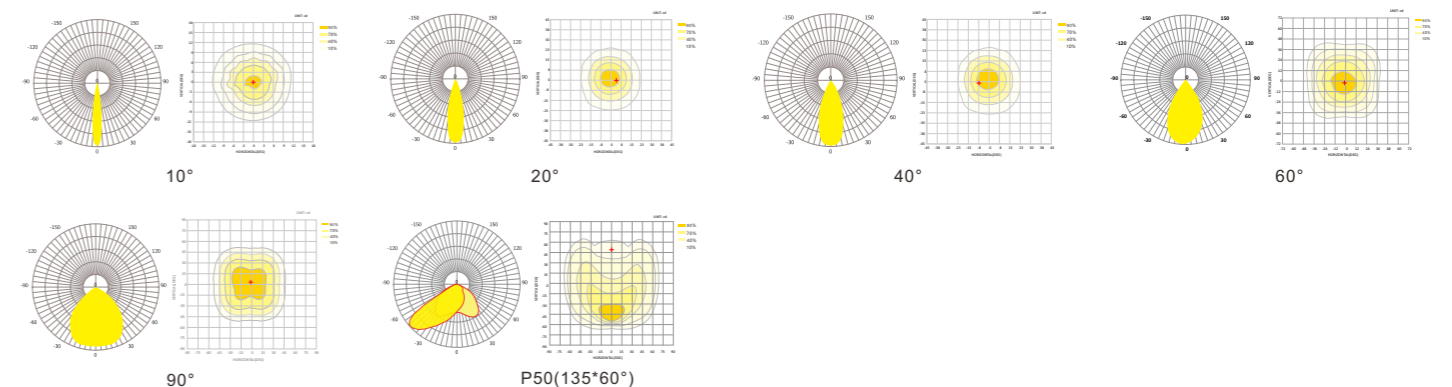

- All Applications**
- Uniformity and light quality
 - Light pollution and spillage
 - Controls



- Baseball, Softball**
- High levels of illumination
 - Lighted from all sides
 - Reducing glare



- Harbors, Wharfs**
- Pole location (primarily sidelines)
 - Pole quantity
 - Number of fixtures per pole



- Soccer, Lacrosse, Mixed Use**
- Pole location
 - Pole quantity
 - Number of fixtures per pole



- Basketball, Tennis**
- Floodlight, or area-style fixtures
 - Court configuration (grouping)
 - Court access

HTO

SLIM MAX SERIES

LED HIGH MAST LIGHT & Flood Light

- Light Source: Lumileds 5050
- Input Volt: 100-277VAC / 374-480V
- Module rotatable 270°
- IK & IP RATING : IK10 IP66
- Housing: Marine grade aluminum
- Color Temp: 3000K 4000K 5000K 5700K
- 5 years warranty



SLIM MAX

LED HIGH MAST LIGHT 240W-1500W

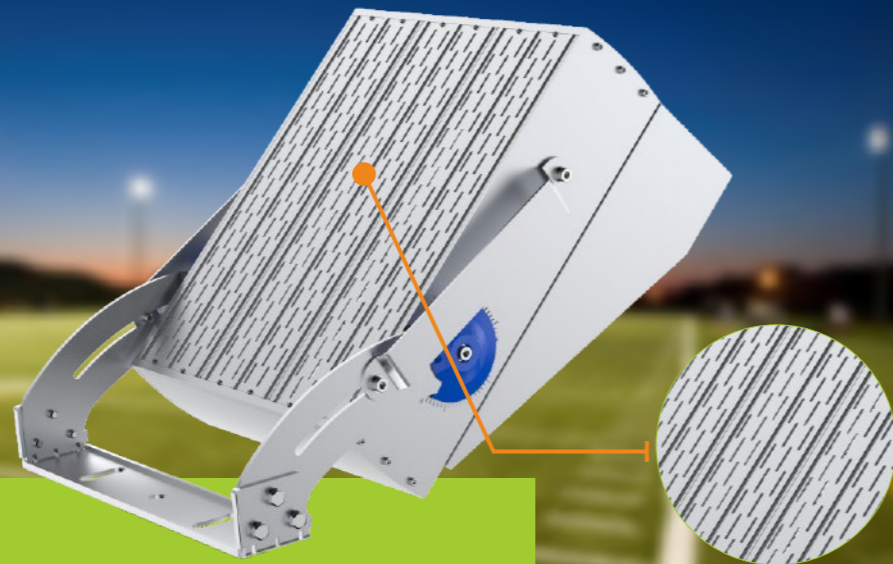

Dustproof Net Protect the lamp from other debris

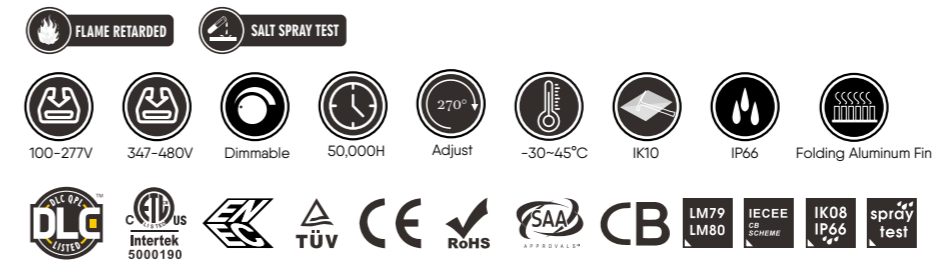

Slim MAX outdoor pole LED sport flood lighting fixtures replace traditional lighting fixtures and can immediately improve the quality of lighting in stadiums, large areas, roads, ports, and airports, and reduce energy consumption by as much as 75%.

180
LM/W



Model	Watt	Efficiency	Lumen	Chip Brand	Dimensions (mm)	Weight
LSHM-200W-LV(XXX)MAX	200W	180LM/W±3%	40,800Lm	Luminleds 5050	185*648.3*147mm	9.5Kg
LSHM-240W-LV(XXX)MAX	240W	170LM/W±3%	40,800Lm	Luminleds 5050	185*648.3*147mm	9.5Kg
LSHM-300W-LV(XXX)MAX	300W	160LM/W±3%	48,000Lm	Luminleds 5050	185*648.3*147mm	10Kg
LSHM-400W-LV(XXX)MAX	400W	180LM/W±3%	81,600Lm	Luminleds 5050	372*744.6*147mm	14.5Kg
LSHM-480W-LV(XXX)MAX	480W	170LM/W±3%	81,600Lm	Luminleds 5050	372*744.6*147mm	14.5Kg
LSHM-600W-LV(XXX)MAX	600W	160LM/W±3%	96,000Lm	Luminleds 5050	372*744.6*147mm	15.5Kg
LSHM-720W-LV(XXX)MAX-B	600W	180LM/W±3%	122,400Lm	Luminleds 5050	520.5*744.6*147mm	18Kg
LSHM-720W-LV(XXX)MAX	720W	170LM/W±3%	122,400Lm	Luminleds 5050	520.5*744.6*147mm	18Kg
LSHM-900W-LV(XXX)MAX	900W	160LM/W±3%	144,000Lm	Luminleds 5050	520.5*744.6*147mm	19.5Kg
LSHM-800W-LV(XXX)MAX	800W	180LM/W±3%	144,000Lm	Luminleds 5050	668.6*744.6*147mm	22Kg
LSHM-960W-LV(XXX)MAX	960W	170LM/W±3%	163,200Lm	Luminleds 5050	668.6*744.6*147mm	22Kg
LSHM-1200W-LV(XXX)MAX	1200W	160LM/W±3%	192,000Lm	Luminleds 5050	668.6*744.6*147mm	24.5Kg
LSHM-1000W-LV(XXX)MAX	1000W	180LM/W±3%	180,000Lm	Luminleds 5050	819*744.6*147mm	29Kg
LSHM-1500W-LV(XXX)MAX	1500W	160LM/W±3%	240,000Lm	Luminleds 5050	819*744.6*147mm	29Kg

Beam Angle

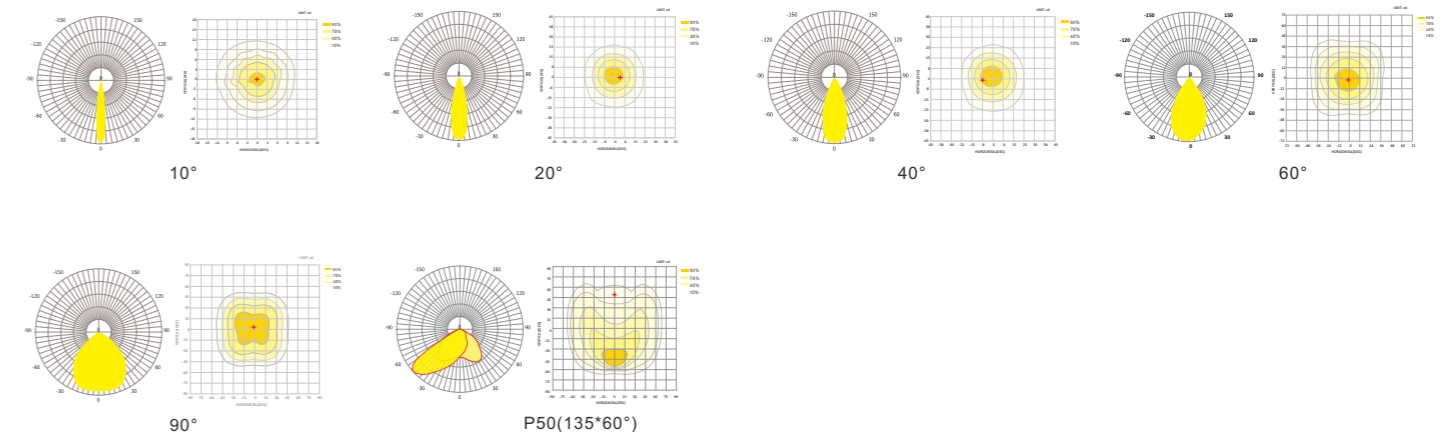

All Applications

- Uniformity and light quality
- Light pollution and spillage
- Controls

Baseball, Softball

- High levels of illumination
- Lighted from all sides
- Reducing glare

Harbors, Wharfs

- Pole location (primarily sidelines)
- Pole quantity
- Number of fixtures per pole

Soccer, Lacrosse, Mixed Use

- Pole location
- Pole quantity
- Number of fixtures per pole

Basketball, Tennis

- Floodlight, or area-style fixtures
- Court configuration (grouping)
- Court access



ULTRA SERIES

LED HIGH MAST LIGHT 480W-1800W

ULTRA SERIES LED SPORTS LIGHT

The Ultra series of LED high- mast lights are sturdy and durable with integrated aluminum alloy die-casting honeycomb heat dissipation design. And the surface has adopted black sand powder spray treatment, corrosion resistance, oxidation resistance, and salt spray resistance. What's more, it uses the stainless steel bracket and Silicone gaskets, and the screws are made of AISI 304 stainless steel.

190
LM/W

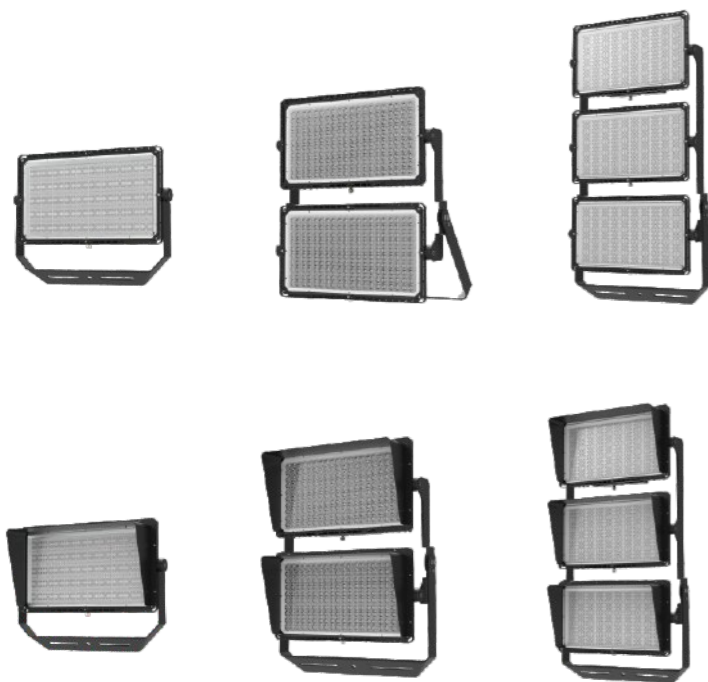

High Luminous Efficiency

The Ultra series led high-pole floodlights are aimed at the application needs of large area lighting. The Ultra series flood lights can be expanded from 480W to 1800W, with a luminous effect of up to 190LM/W and it can be used in various beam angle degree for the different area lighting requirements to achieve better lighting effects.

Ultra

LED HIGH MAST LIGHTS

- Light Source: Luminleds 5050 and 3030
- Input Volt: 100-277VAC / 347-480VAC
- IP Rating IK Rating : IP66 & IK08
- Beam Angle: 10° 20° 40° 60° 90° Type4 135°*60°(P50)
- Color Temp: 3000K 4000K 5000K 5700K 6000K
- 5 years warranty



100-277VAC
347-480VAC

50,000H

Modules

-30~45°C

IK08

IP66

FLAME RETARDED

SALT SPRAY TEST

Model	Watt	Efficiency	Lumen	Chip Brand	Size (LxWxH)	Weight
LSHM-480W-LV(XXX)Ultra	480W	190LM/W±3%	91,200Lm	Luminleds 5050	637x462x134mm	15Kg
LSHM-600W-LV(XXX)Ultra	600W	180LM/W±3%	108,000Lm	Luminleds 5050	637x462x134mm	15Kg
LSHM-960W-LV(XXX)Ultra	960W	190LM/W±3%	182,400Lm	Luminleds 5050	869x678x152mm	32Kg
LSHM-1200W-LV(XXX)Ultra	1200W	180LM/W±3%	216,000Lm	Luminleds 5050	869x678x152mm	32Kg
LSHM-1440W-LV(XXX)Ultra	1440W	190LM/W±3%	273,600Lm	Luminleds 5050	1267x678x152mm	48Kg
LSHM-1800W-LV(XXX)Ultra	1800W	180LM/W±3%	324,000Lm	Luminleds 5050	1267x678x152mm	48Kg

Beam Angle

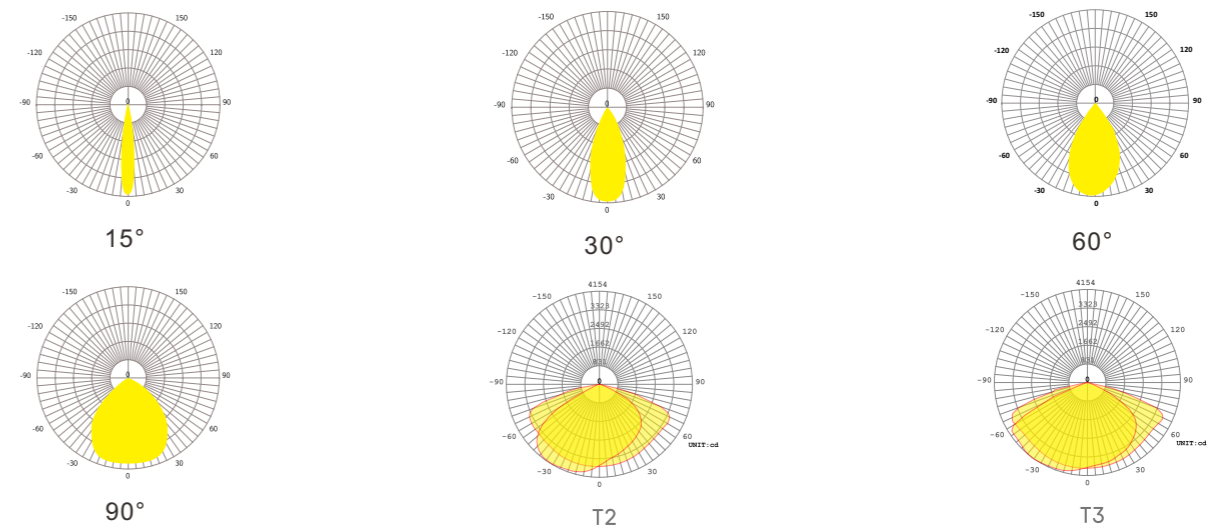



Slim Round

LED HIGH MAST LIGHTS
480W 600W 960W 1200W

- Light Source: Luminleds 5050
- Input Volt: 100-277VAC / 347-480VAC
- IP Rating IK Rating : IP66 & IK10
- Beam Angle: 10° 25° 45° 60°
- Color Temp: 3000K 4000K 5000K 5700K 6000K
- Dimmable: 1-10V
- SPD: 10KV or 20KV
- 5 years warranty

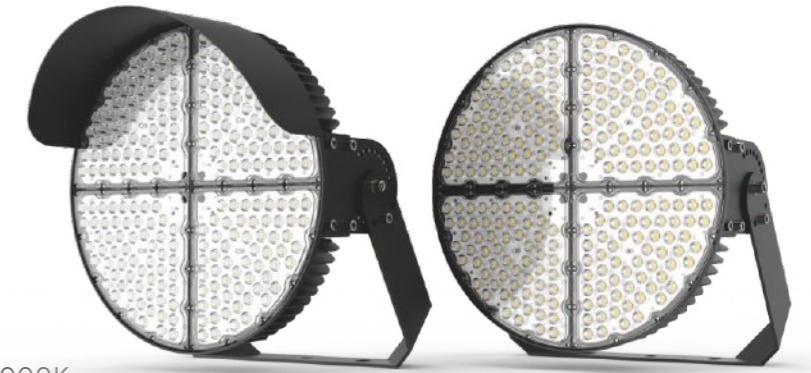

Without anti-glare plate



With anti-glare plate



Slip fitter



Rotatable Arm



100-277V
347-480V



50,000H

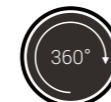

360°
Modules



-40~45°C



IK10



IP66



Wind load
51.0-56.0m/s



FLAME RETARDED



SALT SPRAY TEST

Model	Watt	Efficiency	Lumen	Chip Brand	Size (LxWxH)	Weight
LSRHM-480W-LV(XXK)	480W	160lm/w±3%	76,800Lm	Luminleds 5050	380x620x645mm	19.5Kg
LSRHM-600W-LV(XXK)	600W	160lm/w±3%	96,000Lm	Luminleds 5050	380x620x645mm	19.5Kg
LSRHM-960W-LV(XXK)	960W	160lm/w±3%	153,600Lm	Luminleds 5050	330x460x490mm	34kg
LSRHM-1200W-LV(XXK)	1200W	160lm/w±3%	192,000Lm	Luminleds 5050	330x460x490mm	34kg

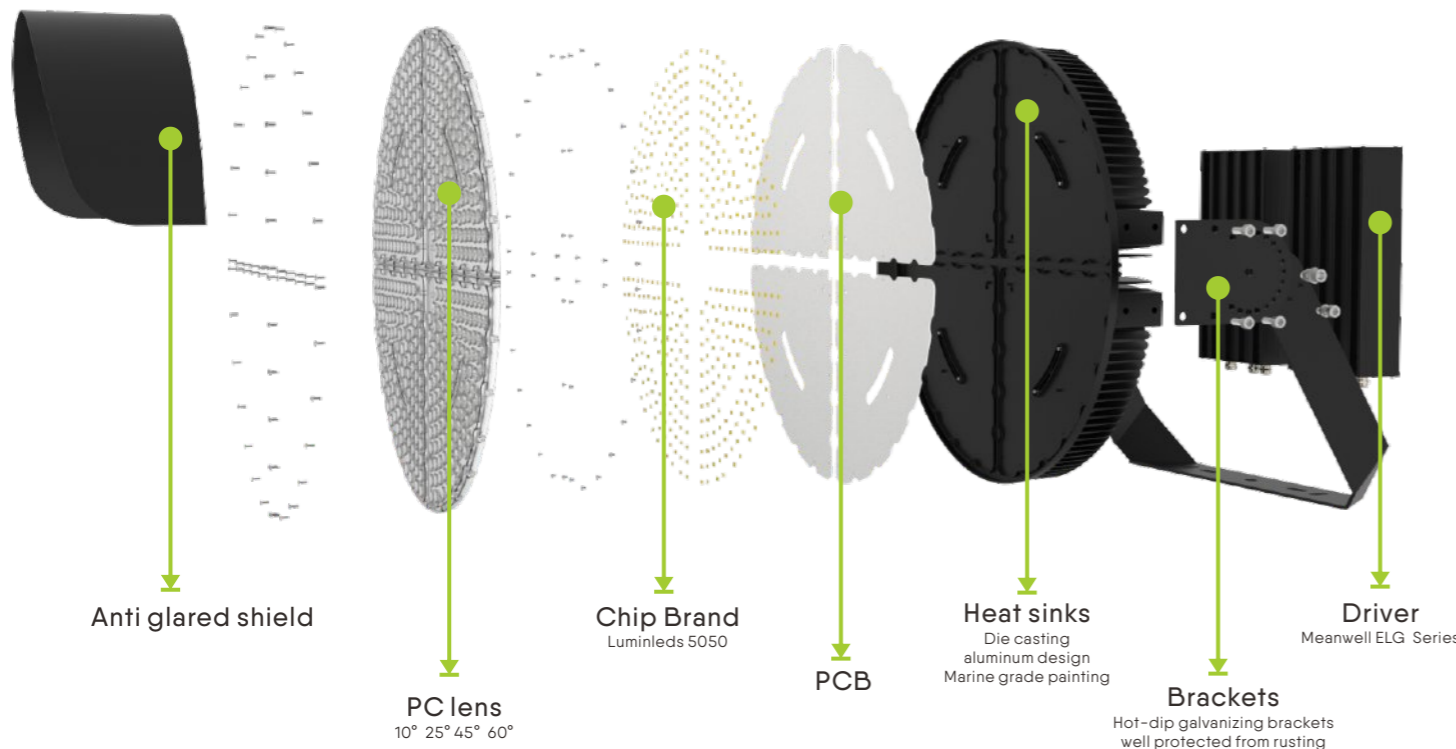

Beam Angle

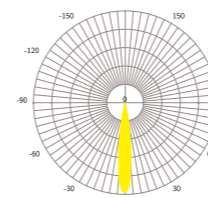

15°

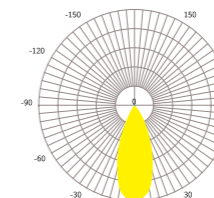

30°

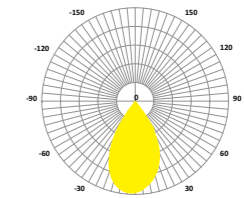

60°

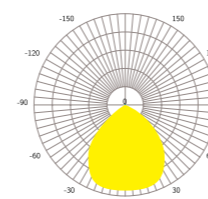

90°

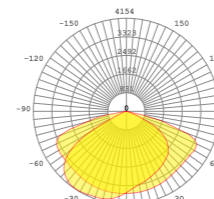

T2

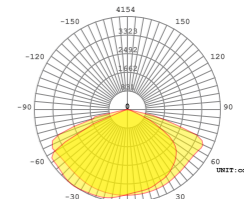

T3

NEW

TRANSFORMER SERIES

LED High Mast Lights

- Light Source: Lumileds 5050
- Input Volt: 100-277VAC
- Module rotatable up & down 360°
- IK & IP Rating : IK10 IP65
- Housing: Marine grade aluminum
- Color Temp: 3000K 4000K 5000K 5700K
- 5 years warranty



TRANSFORMER SERIES

LED HIGH MAST LIGHT 600W-1440W

Model	Watt	Efficiency	Lumen	Driver	Dimensions (mm)	Net weight
LSTHM-B600W-LV(XXX)	600W	160LM/W±3%	96,000Lm	SS-100VA-56	723*694*268	23Kg
LSTHM-B720W-LV(XXX)	720W	155LM/W±3%	111,600Lm	SS-150VA-56	723*694*268	23Kg
LSTHM-B800W-LV(XXX)	800W	160LM/W±3%	128,000Lm	SS-200VA-56	597*650*132	27Kg
LSTHM-B960W-LV(XXX)	960W	155LM/W±3%	148,800Lm	SS-240VA-56	597*650*132	27Kg
LSTHM-B1000W-LV(XXX)	1000W	160LM/W±3%	160,000Lm	SS-320V-54	729*650*132	31.5Kg
LSTHM-B1200W-LV(XXX)	1200W	155LM/W±3%	186,000Lm	2*SS-200VA-56	729*650*132	31.5Kg
LSTHM-B1440W-LV(XXX)	1440W	160LM/W±3%	230,400Lm	2*SS-240VA-56	860*650*132	37Kg

LIGHT WEIGHT FLODED FIN

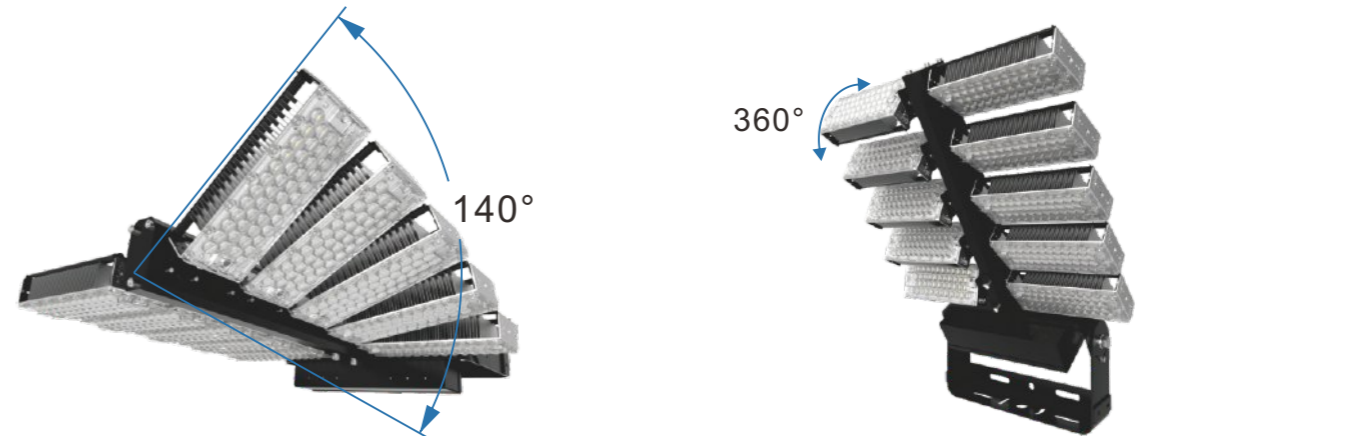
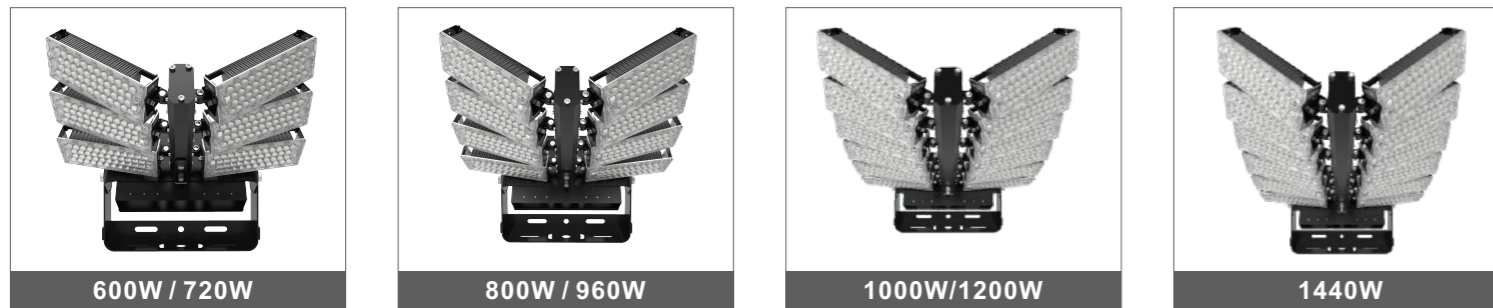

- All Applications**
 - Uniformity and light quality
 - Light pollution and spillage
 - Controls
- Soccer, Lacrosse, Mixed Use**
 - Pole location
 - Pole quantity
 - Number of fixtures per pole
- Baseball, Softball**
 - High levels of illumination
 - Lighted from all sides
 - Reducing glare
- Basketball, Tennis**
 - Floodlight, or area-style fixtures
 - Court configuration (grouping)
 - Court access
- Harbors, Wharfs**
 - Pole location (primarily sidelines)
 - Pole quantity
 - Number of fixtures per pole

Beam Angle

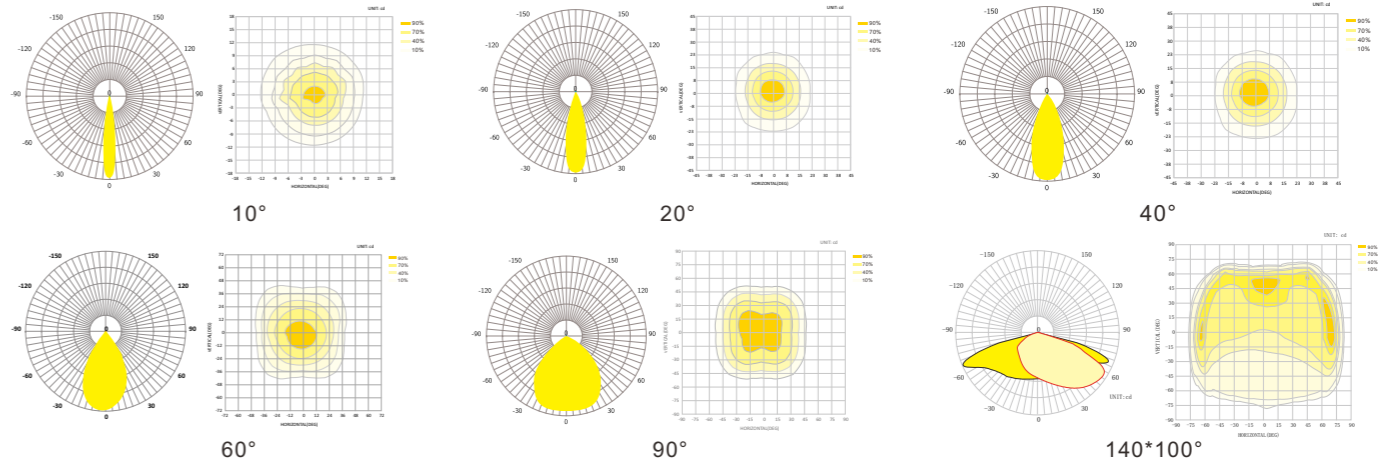

NEW

SLIM SERIES

LED HIGH MAST LIGHT 100W-1440W



SLIM SERIES

LED HIGH MAST LIGHT

- Light Source: Lumileds 3030 / 5050
- Input Volt: 100-277VAC
- Module rotatable up & down 15°
- IK & IP RATING : IK10 IP65
- Housing: Marine grade aluminum
- Color Temp: 3000K 4000K 5000K 5700K
- 5 years warranty



Model	Watt	Efficiency	Lumen	Driver	Dimensions (mm)	Net weight
LSHM-100W-LV(XXK)	100W	160LM/W±3%	16,000Lm	SS-100VA-56	297*362*132	2.4Kg
LSHM-120W-LV(XXK)	120W	160LM/W±3%	19,200Lm	SS-150VA-56	297*362*132	2.7Kg
LSHM-200W-LV(XXK)	200W	160LM/W±3%	32,000Lm	SS-200VA-56	342*362*132	6.0Kg
LSHM-240W-LV(XXK)	240W	160LM/W±3%	38,400Lm	SS-240VA-56	342*362*132	6.0Kg
LSHM-300W-LV(XXK)	300W	160LM/W±3%	48,000Lm	SS-320V-54	475*362*132	8.0Kg
LSHM-400W-LV(XXK)	400W	160LM/W±3%	64,000Lm	2*SS-200VA-56	597*362*132	10.0Kg
LSHM-480W-LV(XXK)	480W	160LM/W±3%	76,800Lm	2*SS-240VA-56	597*362*132	10.0Kg
LSHM-600W-LV(XXK)	600W	160LM/W±3%	96,000Lm	2*SS-320VA-56	861*362*132	13.2Kg
LSHM-720W-LV(XXK)	720W	160LM/W±3%	115,200Lm	3*SS-240VA-56	861*362*132	13.2Kg
LSHM-B400W-LV(XXK)	400W	160LM/W±3%	90,000Lm	2*SS-200VA-56	529*362*132	11Kg
LSHM-B480W-LV(XXK)	480W	160LM/W±3%	76,800Lm	2*SS-240VA-56	529*362*132	11Kg
LSHM-B600W-LV(XXK)	600W	160LM/W±3%	96,000Lm	3*SS-240VA-56	649*375*132	14Kg
LSHM-B720W-LV(XXK)	720W	160LM/W±3%	115,200Lm	3*SS-240VA-56	649*375*132	14Kg
LSHM-B800W-LV(XXK)	800W	160LM/W±3%	128,000Lm	4*SS-240VA-56	597*650*132	18Kg
LSHM-B960W-LV(XXK)	960W	160LM/W±3%	153,600Lm	4*SS-240V-54	597*650*132	18Kg
LSHM-B1000W-LV(XXK)	1000W	160LM/W±3%	160,000Lm	5*SS-240VA-56	729*650*132	21.5Kg
LSHM-B1200W-LV(XXK)	1200W	160LM/W±3%	192,000Lm	5*SS-240VA-56	729*650*132	21.5Kg
LSHM-B1440W-LV(XXK)	1440W	160LM/W±3%	230,400Lm	6*SS-240VA-56	860*650*132	25.0Kg

Beam Angle

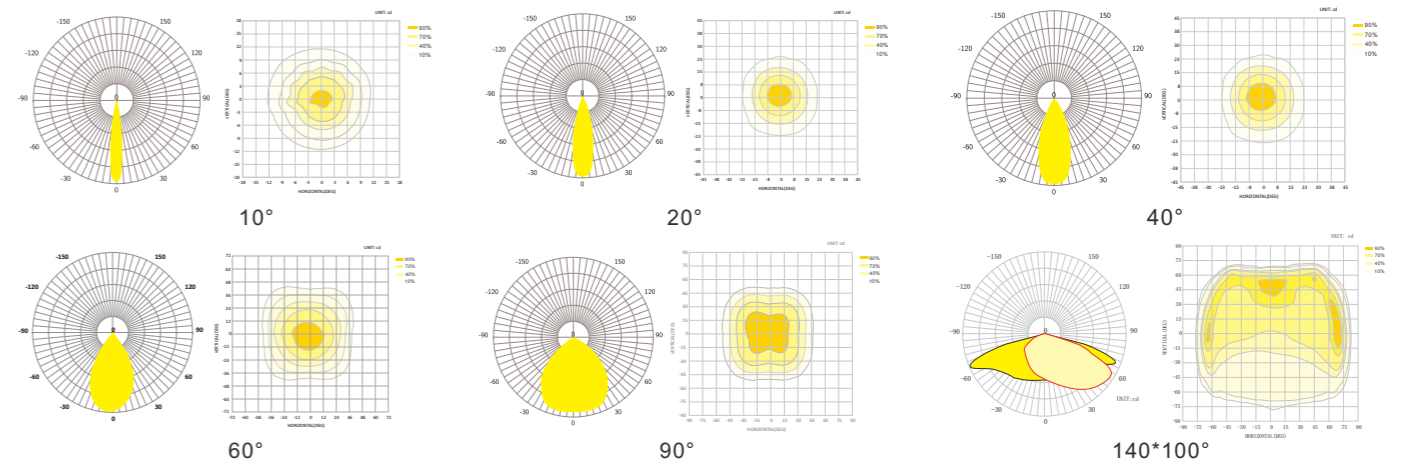

LIGHT WEIGHT FLODED FIN



- All Applications**
 - Uniformity and light quality
 - Light pollution and spillage
 - Controls
- Baseball, Softball**
 - High levels of illumination
 - Lighted from all sides
 - Reducing glare
- Harbors, Wharfs**
 - Pole location (primarily sidelines)
 - Pole quantity
 - Number of fixtures per pole
- Soccer, Lacrosse, Mixed Use**
 - Pole location
 - Pole quantity
 - Number of fixtures per pole
- Basketball, Tennis**
 - Floodlight, or area-style fixtures
 - Court configuration (grouping)
 - Court access





SLIM FIN SERIES







UFO LED HIGH BAY LIGHT

SLIM FIN SERIES

UFO LED HIGH BAY LIGHT

- Light Source: Osram 2835
- Input Volt: 100-277VAC
- IP Rating: IP65
- Lifespan: > 50,000 hours
- Color Temp: 4000K 5000K 5700K
- 5 years warranty



-  100-277V
347-480V
-  50,000H
-  Dimmable
-  -30~45°C
-  Ik10
-  IP65

Folding Aluminum Fin Design

Which Are Very Light Weight

5
Years
Warranty

50000
Hour
Long Service Life

Part Number	LSUFO-100WXY-LVS(XXK)	LSUFO-150WXY-LVSS(XXK)	LSUFO-200WXY-LVSS(XXK)	LSUFO-240WXY-LVSS(XXK)
Watt	100W	150W	200W	240W
Efficiency	130Lm/W / 160Lm/W	130Lm/W / 160Lm/W	130Lm/W / 160Lm/W	130Lm/W / 160Lm/W
Dimensions (mm)	Dia234 x H145mm	Dia234 x H145mm	Dia277 x H145mm	420*133mm
Lumen	13,000Lm / 16,000Lm	19,500Lm / 24,000Lm	26,000Lm / 32,000Lm	31,200Lm / 38,400Lm
Driver	SS-120CNL-130	SS-150CNL-260	SS-200CNL-260	SS-240CNL-260
Net weight	1.65Kg	1.65Kg	2.2Kg	5.6Kg



- High luminaire efficiency up to 160lm/w, CRI > 80
- Mounting Height: 6-20meter
- IP65 and Ik10 protection rate
- Folding aluminum fin design which are very light weight
- 5 years warranty

XY stands for D , which is short for Dimmable . XY stands for ND , which is short for Non-dimmable
 LVS stands for Low Voltage, S stands for Slim, S stands for Sosen driver
 XXK stands for color temperature 3000K, 4000K, 4500K, 5000K, 5700K







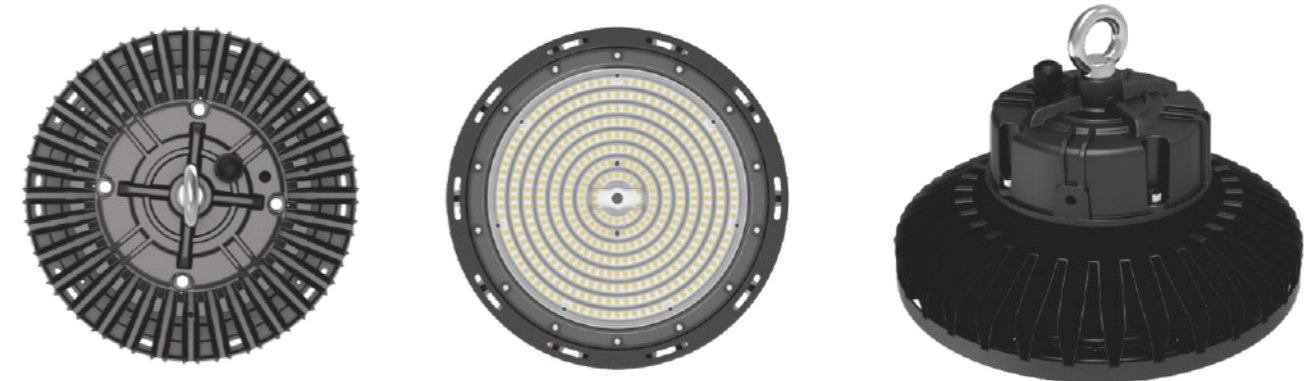

Beam Angle

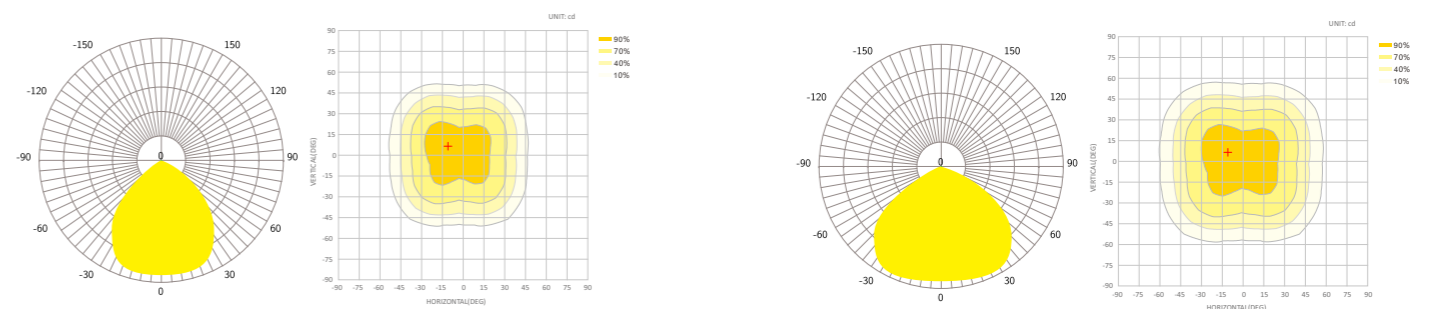

90°

120°

NEW

SLIM SERIES

UFO LED HIGH BAY LIGHT

- Light Source: Osram 2835
- Input Volt: 100-277VAC
- IP Rating: IP65
- Lifespan: > 50,000 hours
- Color Temp: 4000K 5000K 5700K
- 5 years warranty



SLIM SERIES

UFO LED HIGH BAY LIGHT



- 100-277V / 347-480V
- 50,000H
- Dimmable
- 30~45°C
- IK10
- IP65

LIGHTER IN WEIGHT SMALLER IN SIZE
SAVE SHIPPING COST HIGH LUMENS EFFICACY

5
Years
Warranty

50000
Hour
Long Service Life

Part Number	LSUFO-100WXY-LVSS(XXK)	LSUFO-150WXY-LVSS(XXK)	LSUFO-200WXY-LVSS(XXK)	LSUFO-240WXY-LVSS(XXK)
Watt	100W	150W	200W	240W
Efficiency	160Lm/W	150Lm/W / 160Lm/W	150Lm/W	150Lm/W
Dimensions (mm)	300*114mm	300*114mm	360*124mm	420*133mm
Lumen	16,000Lm	22,500Lm / 24,000Lm	30,000Lm	36,000Lm
Driver	SS-120CNL-130	SS-150CNL-260	SS-200CNL-260	SS-240CNL-260
Net weight	2.35Kg	2.65Kg	4.5Kg	5.6Kg



Dali dimmable

- The lightest UFO high bay in the market. Only 2.5kg for standards, and diameter is 300mm.
- Top performance & Less 40-50% size than other, can save more freight cost.
- Black & Aluminum grey, Transparent cover for option.
- Long life span and less brightness degradation.
- Efficiency of power supply is more than 90%.
- No UV and near-IR radiation in the light beam.
- Merryteck sensors and Zigbee system compliable.
- Tempered glass, PC reflector, Aluminum reflector, Yoke Bracket, milky cover are available
- Certificates ETL cETL DLC Premium TUV CE RoHS SAA c-tick CB Lm79 LM80

Save **50%** on shipping costs



other UFO led high bay light can only put 1000pcs at 20ft containers.



Our slim UFO LED High Bay Light can put **1,500pcs** at a 20ft container.

Beam Angle

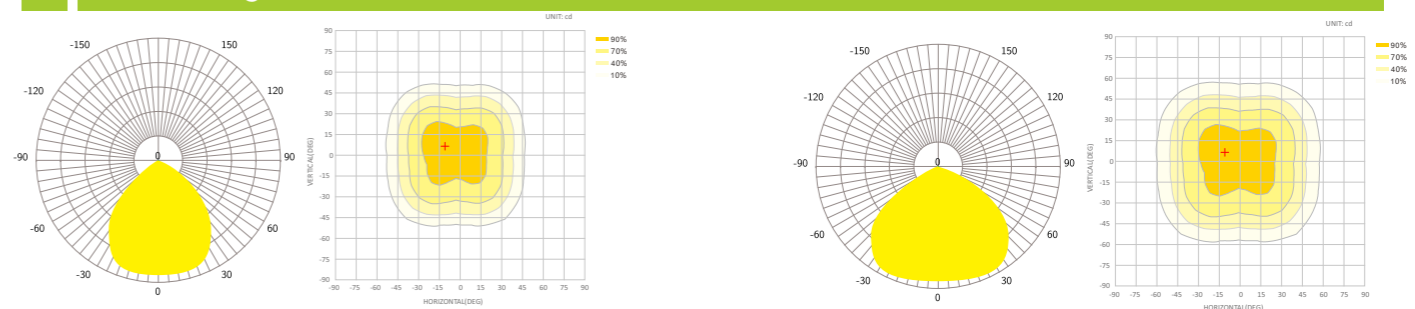

90°

120°







NEW

RGO SERIES

Built-in induction sensor UFO led high bay light

- Light Source: Osram 2835
- Input Volt: 100-277VAC
- IP Rating: IP65
- Lifespan: > 50,000 hours
- Color Temp: 4000K 5000K 5700K
- 5 years warranty



 100-277V 347-480V	 50,000H	 Dimmable	 -30~45°C	 IK10	 IP65
---	--	---	---	---	---

RGO SERIES

GRAPHENE UFO LED HIGH BAY LIGHT



GRAPHENE HEAT SINK

The heat sink is made of graphene material, and graphene has excellent thermal conductivity. The thermal conductivity is up to 5300W/m.k. Its thermal conductivity is higher than that of copper, aluminum, iron and other metals.

5
Years
Warranty

50000
Hour
Long Service Life



Intermediate embedded induction sensor which helps reduce package size

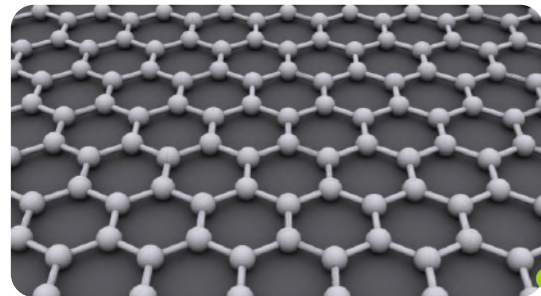
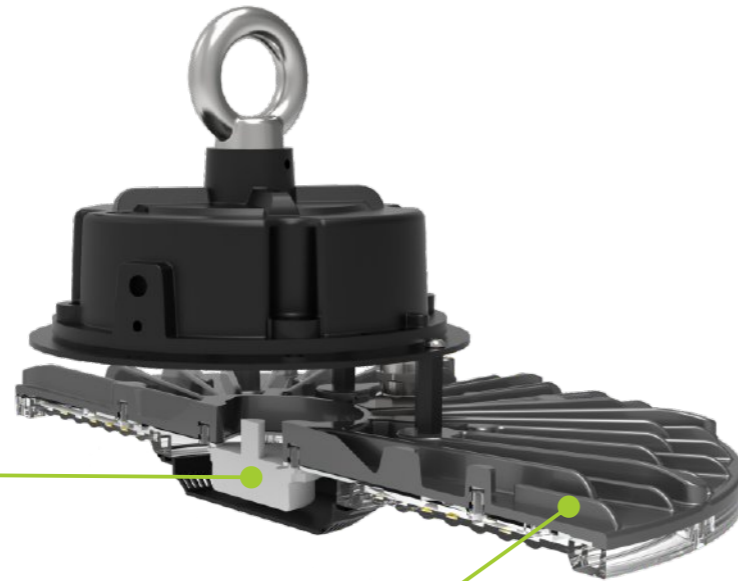

The heat sink uses graphene material to improve heat dissipation

Part Number	LSUFO-100WXY-GS(XXK)	LSUFO-150WXY-GS(XXK)
Watt	100W	150W
Efficiency	150Lm/W	150Lm/W
Dimensions (mm)	288.5*105.4mm	320*109.9mm
Lumen	15,000Lm	22,500Lm
Driver	SS-120CNL-130	SS-150CNL-260
Net weight	2.27Kg	2.64Kg

Lux on/off

Preconditions to use the Lux-off function:

1. Standby period is +∞;
2. Standby dimming level is on 10%, 20% or 30%;
3. Daylight threshold is on 30Lux, 50Lux, 80Lux or 120Lux.

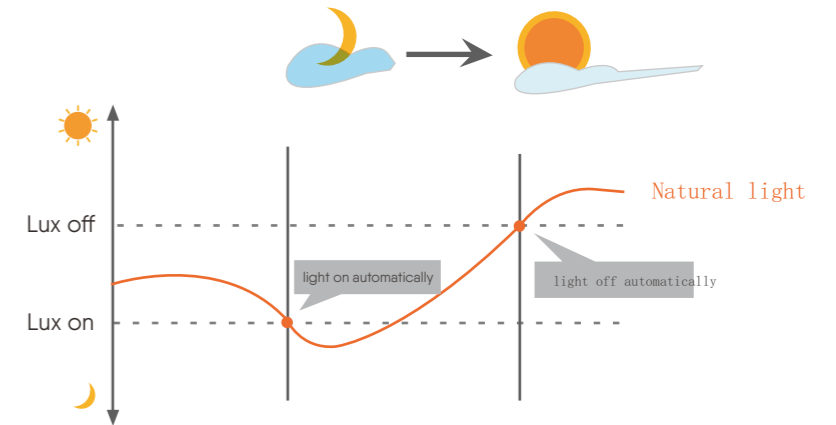

Application—Lux on/off



Light automatically on when ambient brightness is lower than preset lux level.



With insufficient ambient brightness, light dims to 100% when motion detected.

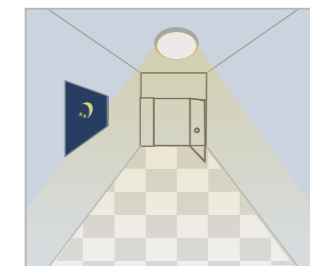

Light dims to standby level if no motion detected after holdtime.

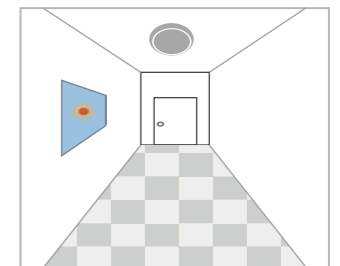

Light off when ambient lux level is higher than preset lux amount.









Anti-Glared Tennis court lighting

NEMO SERIES 180Lm/W LED FLOODLIGHTING



NEMO SERIES LED FLOODLIGHTING

- Light Source: Lumileds 5050
- Input Volt: 100-277VAC / 200-240VAC
- IP Rating: IP65 IK08
- Certificates: ETL DLC ENEC TUV CE RoHS CB SAA
- Color Temp: 4000K 5000K 5700K
- Buckle design, tool free open and maintenance
- Buckle and tempered glass all hang to the lamp when opens
- Various lens, PCB board and drivers changeable
- 5 years warranty



▲ Linkable Floodlights available

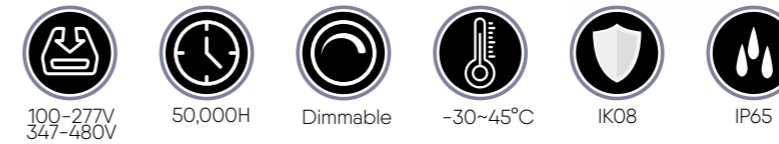

TENNIS COURT LIGHTING

Anti-Glaring Special for tennis court



Part Number	LSNFL-100W(XXK)	LSNFL-150W(XXK)	LSNFL-200W(XXK)	LSNFL-240W(XXK)	LSNFL-300W(XXK)
Watt	100W	150W	200W	240W	300W
Efficiency	160Lm/W or 180Lm/W	155Lm/W or 185Lm/W	150Lm/W or 180Lm/W	145Lm/W or 180Lm/W	155Lm/W or 180Lm/W
Dimensions (mm)	441x357x60mm	441x357x60mm	447x387x60mm	447x387x60mm	518x477x60mm
Lumen	16,000Lm / 18,000Lm	23,250Lm / 27,750Lm	30,000Lm / 36,000Lm	34,800Lm / 43,200Lm	46,500Lm / 54,000Lm
Driver	XLG-100-H-A	XLG-150-H-A	XLG-240-H-A	XLG-240-H-A	2*XLG-150-H-A



Beam Angle

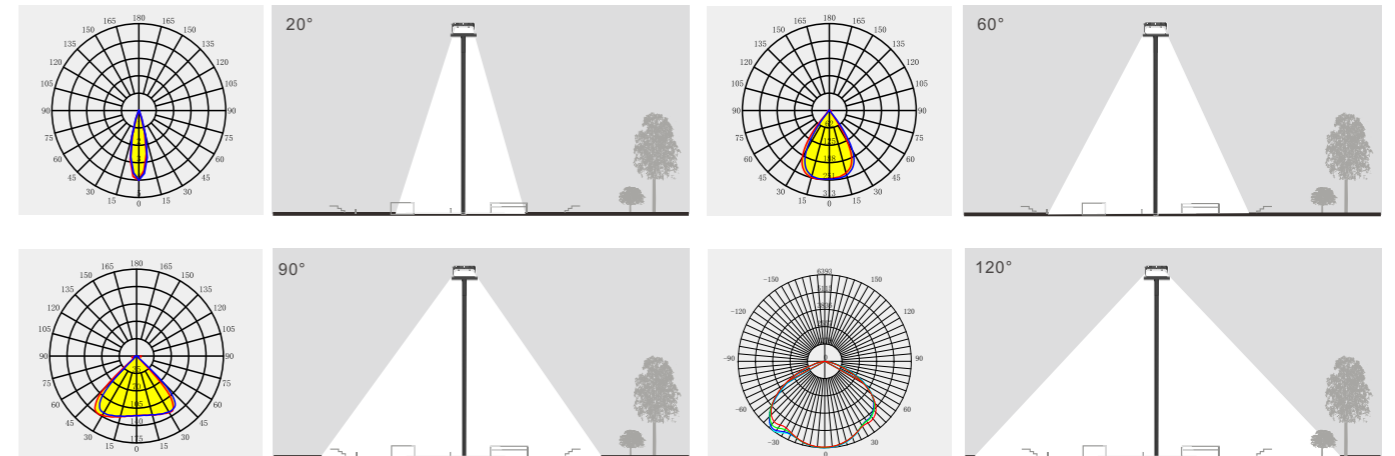

Special for tennis court (Anti-Glaring)

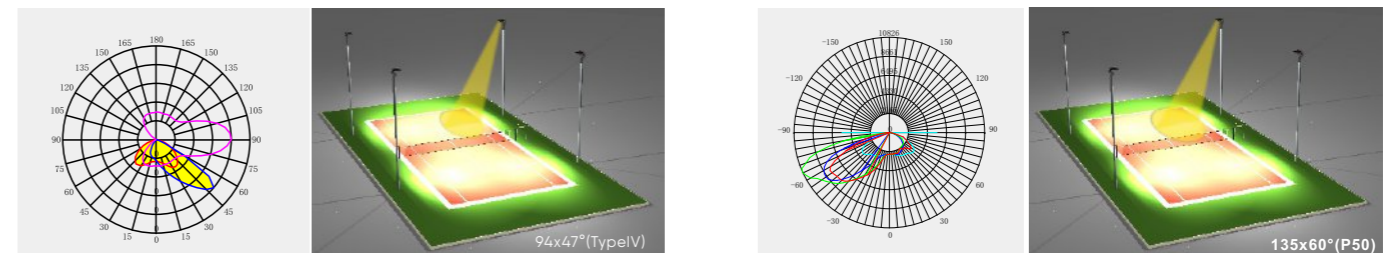

ACCESSORY: PHOTOCELL Optional

This fixture is optional with photocell sensor
 • Photocell integration controls 120-277Volt



Photocell
On at Dusk and Off at Dawn.

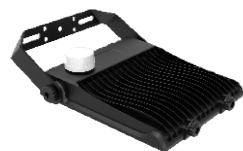

0-10V NEMA dimming



Anti-glare plate

ACCESSORY: SURGE PROTECTION DEVICE

This fixture is optional with 10KV or 20KV SPD.

SPD surge protection devices is perfectly adapted for outdoor lighting to provide single phase protection for line/neutral, line/ground and neutral/ground in accordance with IEEE C62.41 2002 C High, UL1449 and IEC61643-11



Optional



Slip Fitter



SLIM SERIES

LED FLOODLIGHT 10W - 400W

LED FLOOD LIGHT

die-cast aluminum enclosure resists corrosion, dust, insects, and weather

5
Years
Warranty

50000
Hour
Long Service Life



SILM SERIES

LED FLOODLIGHT

- Light Source: Lumileds 3030
- Input Volt: 100-277VAC
- IP Rating : IP65
- Beam Angle: 120°
- Color Temp: 3000K 4000K 5000K 5700K
- Certificate: CE RoHS SAA ETL DLC
- Optional Beam Angle: 8° 15° 30° 60° 90°
- 5 years warranty



White housing
Black housing



Part Number	LSSFL-10W	LSSFL-20W	LSSFL-30W	LSSFL-50W	LSSFL-80W
Watt	10W	20W	30W	50W	80W
Efficiency	100LM/W±3%	100LM/W±3%	100LM/W±3%	100LM/W±3%	120LM/W / 150LM/W
Dimensions (mm)	6.5*4.6*1.3"	8.5*6.0*1.6"	8.9*6.6*1.6"	12.2*8.7*2.0"	13.9*9.6*2.2"
Lumen	1,000Lm	2,000Lm	3,000Lm	5,000Lm	9,600Lm / 12,000Lm
Driver	TUV CE Driver	TUV CE Driver	TUV CE Driver	TUV CE Driver	XLG-100-H-A
Weight	0.48Kg	0.85Kg	1.17Kg	1.89Kg	4.7Kg

Part Number	LSSFL-100W	LSSFL-150W	LSSFL-200W	LSSFL-300W	LSSFL-400W
Watt	100W	150W	200W	300W	400W
Efficiency	120LM/W / 150LM/W	120LM/W / 150LM/W	120LM/W / 150LM/W	130LM/W / 150LM/W	130LM/W / 150LM/W
Dimensions (in)	15.8*11.6*2.4"	16.9*13*2.4"	18.5*14.2*2.4"	18"x2.55"x22.24"	22"x2.75"x23"
Lumen	12,000Lm / 15,000Lm	18,000Lm / 22,500Lm	24,000Lm / 30,000Lm	39,000Lm / 45,000Lm	52,000Lm / 60,000Lm
Driver	XLG-100-H-A	XLG-150-H-A	XLG-240-H-A	2*XLG-150-H-A	2*XLG-240-H-A
Weight	5.48Kg	6.90Kg	8.26Kg	10.6Kg	15.3Kg



Beam Angle

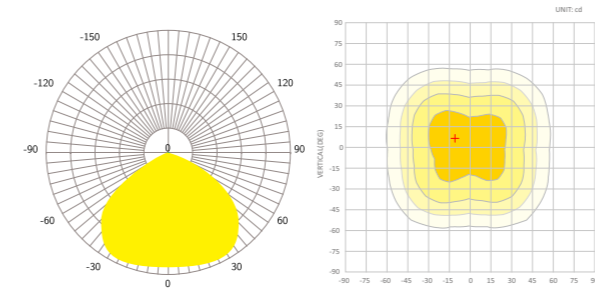

120°



MARS SERIES

LED STREET LIGHT 40W - 200W

NEW

MARS SERIES

LED STREET LIGHT

- Light Source: Lumileds 3030
- Input Volt: 100-277VAC / 200-240VAC
- IP Rating: IP66 IK08
- Beam Angle: Type2, Type3
- Color Temp: 4000K 5000K 5700K
- Arm Dia: 60mm / 76mm
- Complete illumination across the entire roadway
- No external reflectors required
- 5 years warranty



100-277V
 50,000H
 Dimmable
 -30~45°C
 IK08
 IP66

FLAME RETARDED
 SALT SPRAY TEST

LM79
 LM80
 ISTMT
 TM21

LED STREET LIGHT

LED Cobra Head Street Light

5 Years Warranty
 50000 Hour Long Service Life



Constitute



Installation



	TINY MODEL	TINY MODEL	SMALL MODEL	SMALL MODEL
Part Number	LSMSL-T40W-LV(XXK)	LSMSL-T60W-LV(XXK)	LSMSL-S80W-LV(XXK)	LSMSL-S100W-LV(XXK)
Watt	40W	60W	80W	100W
Efficiency	145LM/W±3%	135LM/W±3%	135LM/W±3%	130LM/W±3%
Dimensions (in)	17.28**7.2**5.27"	17.28**7.2**5.27"	18.7**10.2**3.74"	18.7**10.2**3.74"
Lumen	5,800Lm	8,100Lm	10,800Lm	13,000Lm
Driver	XLG-50-H-A	XLG-75-H-A	ELG-100-48A	ELG-100-48A
Surge protection	6KV	6KV	10KV	10KV

	MEDIUM MODEL	MEDIUM MODEL	LARGE MODEL	LARGE MODEL
Part Number	LSMSL-M120W-LV(XXK)	LSMSL-M150W-LV(XXK)	LSMSL-L180W-LV(XXK)	LSMSL-L200W-LV(XXK)
Watt	120W	150W	180W	200W
Efficiency	140LM/W±3%	130LM/W±3%	140LM/W±3%	135LM/W±3%
Dimensions (in)	22.07**12**3.97"	22.07**12**3.97"	24**12.99**4.37"	24**12.99**4.37"
Lumen	16,800Lm	22,500Lm	25,200Lm	27,000Lm
Driver	ELG-100-48A	ELG-150-48A	ELG-240-48A	ELG-240-48A
Surge protection	10KV	10KV	10KV	10KV



Beam Angle

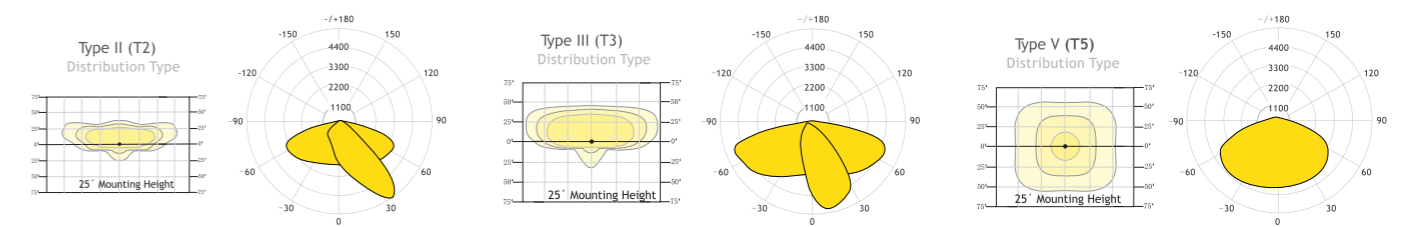



PLUTO SERIES

LED STREET LIGHT 40W-200W

PLUTO SERIES

LED STREET LIGHT

- Light Source: Lumileds 5050
- Input Volt: 100-277VAC
- IP Rating: IP66 IK08
- Beam Angle: Type2, Type3
- Color Temp: 3000K 4000K 5000K 5700K
- Arm Dia: 60mm
- Housing thickness: 2.5mm
- Photocell: On at Dusk and Off at Dawn. 0-10V NEMA dimming
- 5 years warranty

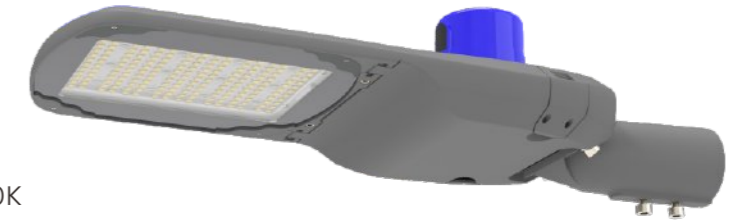

100-277V
 50,000H
 Dimmable
 -30~45°C
 IK08
 IP66

FLAME RETARDED
 SALT SPRAY TEST
 LM79
 LM80
 ISTMT
 TM21

LED STREET LIGHT

LED Cobra Head Street Light

5 Years Warranty
 50000 Hour Long Service Life

40W/60W	80W/100W	120W/150W	180/200W

▼ MOUNTING OPTIONS / Photocell

The Mars fixture can be mounted horizontally or vertically with our universal slip fit system. Simply detach and rotate the slip fitter 180°. to achieve the vertical orientation. Both orientation options include the ability to rotate 15° or more.



Horizontal MOUNTING
Post-top position
(rotates ±15°)



Vertical MOUNTING
Side-entry position
(rotates ±15°)

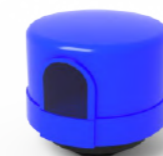

Photocell
On at Dusk and Off at Dawn.

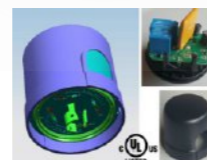

Photocell
0-10V NEMA dimming

	TINY MODEL	TINY MODEL	SMALL MODEL	SMALL MODEL
Part Number	LSPSL-40W-LV(XXK)	LSPSL-60W-LV(XXK)	LSPSL-80W-LV(XXK)	LSPSL-100W-LV(XXK)
Watt	40W	60W	80W	100W
Efficiency	150LM / 145LM/W±3%	150LM / 135LM/W±3%	150LM / 130LM/W±3%	150LM/W±3% / 130LM/W±3%
Dimensions (in)	17.16"x7.87"x9.57"	17.16"x7.87"x9.57"	19.29"x9.17"x9.57"	19.29"x9.17"x9.57"
Lumen	6,000Lm / 5,800Lm	9,000Lm / 8,100Lm	12,000Lm / 10,400Lm	15,000Lm / 13,000Lm
Driver	XLG-50-H-A	XLG-75-H-A	XLG-100-H-A	XLG-100-H-A
Surge protection	6KV	6KV	10KV	10KV

	MEDIUM MODEL	MEDIUM MODEL	LARGE MODEL	LARGE MODEL
Part Number	LSPSL-120W-LV(XXK)	LSPSL-150W-LV(XXK)	LSPSL-180W-LV(XXK)	LSPSL-200W-LV(XXK)
Watt	120W	150W	180W	200W
Efficiency	150LM or 130LM/W±3%	150LM or 130LM/W±3%	150LM or 130LM/W±3%	150LM or 130LM/W±3%
Dimensions (in)	21.77"x10.24"x9.57"	21.77"x10.24"x9.57"	30.5"x12.59"x4.72"	30.5"x12.59"x4.72"
Lumen	18,000Lm / 15,600Lm	22,500Lm / 19,500Lm	27,000Lm / 23,400Lm	30,000Lm / 26,000Lm
Driver	XLG-150-H-A	XLG-150-H-A	XLG-240-H-A	XLG-240-H-A
Surge protection	10KV	10KV	10KV	10KV

Beam Angle

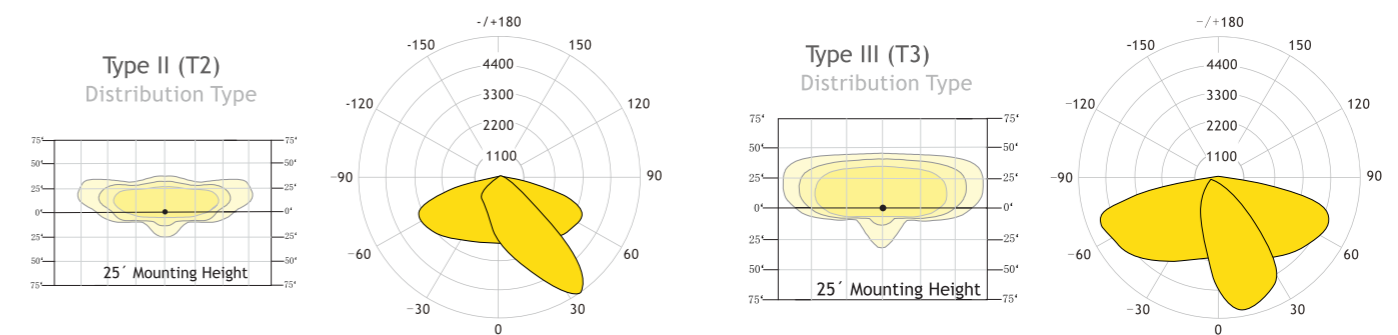

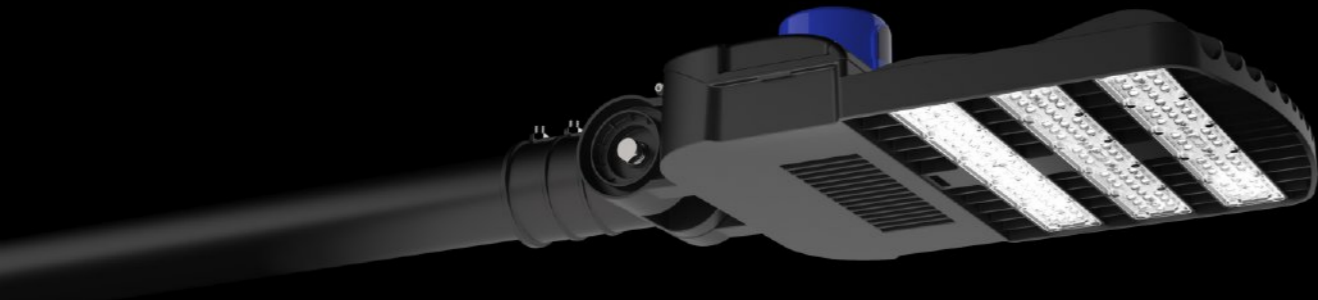

VENUS SERIES

LED STREET LIGHT 50W-240W

LED STREET LIGHT

LED Outdoor Street Light

5 Years Warranty
50,000 Hour Long Service Life



▼ MOUNTING OPTIONS

The Venus led street light fixture includes simple installation with convenient adjustability.
The Venus led street light fixture can be mounted horizontally or vertically.

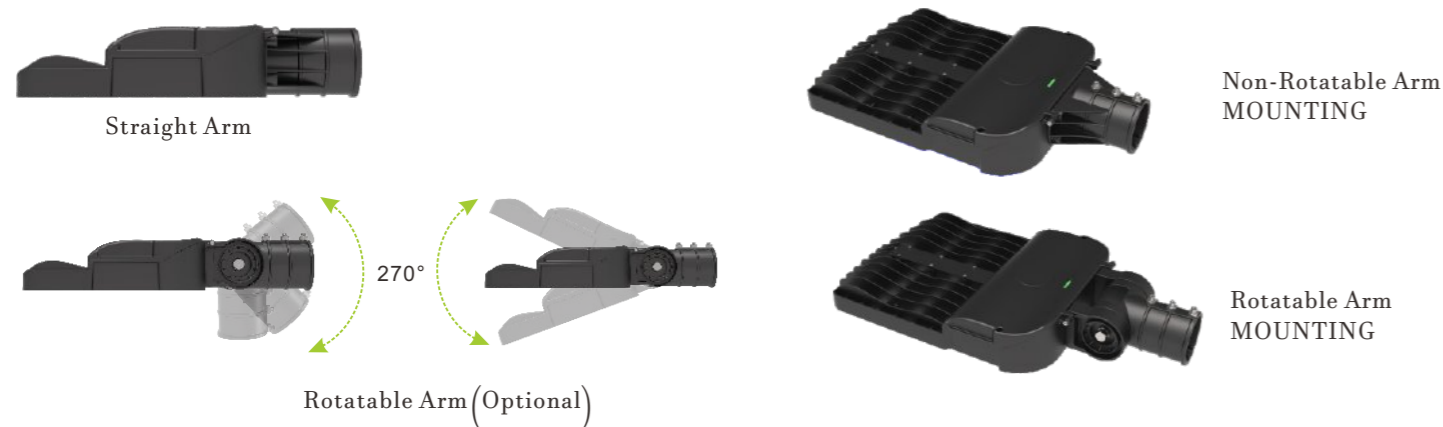

VENUS SERIES

LED STREET LIGHTS

- Light Source: Lumileds 3030
- Input Volt: 100-277VAC
- IP Rating IK Rating : IP67 IK08
- Beam Angle: Type3 80°*155°
- Color Temp: 3000K 4000K 5000K 5700K
- Arm Dia: 60mm
- 5 years warranty



□ White housing
■ Black housing

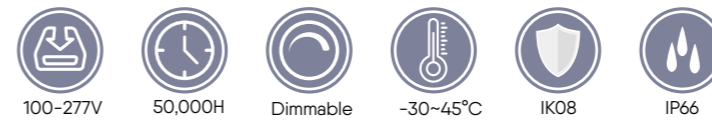

Part Number	LSVSL-50W-LV(XXK)	LSVSL-60W-LV(XXK)	LSVSL-80W-LV(XXK)	LSVSL-100W-LV(XXK)
Watt	50W	60W	80W	100W
Efficiency	150LM/W±3%	150LM/W±3%	150LM/W±3%	150LM/W±3%
Dimensions (mm)	406*320*86mm	406*320*86mm	417*320*86mm	417*320*86mm
Lumen	7,500Lm	9,000Lm	12,000Lm	15,000Lm
Driver	XLG-50-H-A	XLG-75-H-A	XLG-100-H-A	XLG-100-H-A

Part Number	LSPSL-120W-LV(XXK)	LSVSL-150W-LV(XXK)	LSPSL-180W-LV(XXK)	LSPSL-200W-LV(XXK)	LSPSL-240W-LV(XXK)
Watt	100W	120W	180W	200W	240W
Efficiency	150LM/W±3%	150LM/W±3%	150LM/W±3%	150LM/W±3%	150LM/W±3%
Dimensions (in)	548*320*86mm	548*320*86mm	619*320*86mm	619*320*86mm	690*320*86mm
Lumen	15,000Lm	18,000Lm	27,000Lm	30,000Lm	36,000Lm
Driver	XLG-150-H-A	XLG-150-H-A	XLG-240-H-A	XLG-240-H-A	XLG-240-H-A



Beam Angle

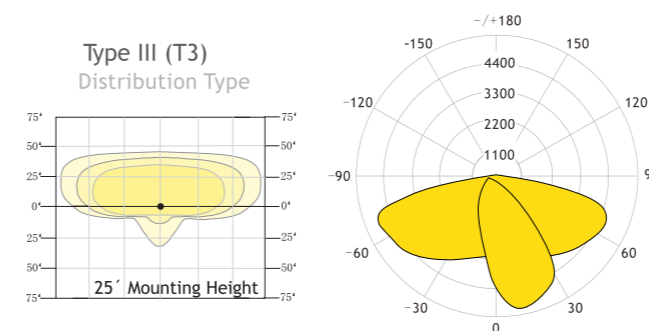

SATURN SERIES

LED STREET LIGHT 20W-200W



SATURN SERIES

LED STREET LIGHTS

- Light Source: Lumileds 3030
- Input Volt: 100-240VAC
- IP Rating IK Rating : IP67 IK08
- Beam Angle: Type2 Type3 Type4
- Color Temp: 3000K 4000K 5000K 5700K 6000K
- Arm Dia: 60mm / 42mm(20-60W)
- 5 years warranty



- White housing
- Gray housing
- Black housing



100-277V



50,000H



Dimmable



-30~45°C



IK08



IP67



LM79

LM80

ISTMT

TM21

LED STREET LIGHT

LED Outdoor Street Light



20W/30W/40W/50W/60W



80W/100W



120W/150W/180W/200W

Installation Accessories



2 Lights Adaptor
Coner bracket



L bracket for 60mm
pole post top

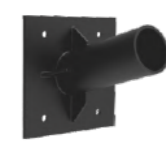

Wall Mount Bracket
adaptor for dia 60mm
spigot



Corner Adaptor



Rotatable adaptor
(dia 60mm to dia 60mm)
(dia 60mm to dia 76mm)



Photocell sensor



NEMA 5pins



NEMA 7pins



NEMA short cap



10KV SPD

Part Number	LSSSL-20W(XXK)	LSSSL-30W(XXK)	LSSSL-40W(XXK)	LSSSL-50W(XXK)	LSSSL-60W(XXK)	LSSSL-80W(XXK)
Watt	20W	30W	40W	50W	60W	80W
Efficiency	140LM/W±3%	135LM/W±3%	135LM/W±3%	130LM/W±3%	130LM/W±3%	135LM/W±3%
Dimensions (mm)	491*190*82mm	491*190*82mm	491*190*82mm	491*190*82mm	491*190*82mm	547*240*82mm
Lumen	2,800Lm	4,050Lm	5,400Lm	6,500Lm	7,800Lm	10,800Lm
Driver	SS-30VA-56	SS-30VA-56	SS-50VA-56	SS-50VA-56	SS-60H-54	SS-100GA-56

Part Number	LSSSL-100W(XXK)	LSSSL-120W(XXK)	LSSSL-150W(XXK)	LSSSL-180W(XXK)	LSSSL-200W(XXK)
Watt	100W	120W	150W	180W	200W
Efficiency	135LM/W±3%	135LM/W±3%	135LM/W±3%	130LM/W±3%	125LM/W±3%
Dimensions (in)	547*240*82mm	549*280*92mm	549*280*92mm	549*280*92mm	549*280*92mm
Lumen	13,500Lm	16,200Lm	20,250Lm	23,400Lm	26,000Lm
Driver	SS-150GA-56	SS-150GA-56	SS-150GA-56	SS-200GA-56	SS-200GA-56



Beam Angle

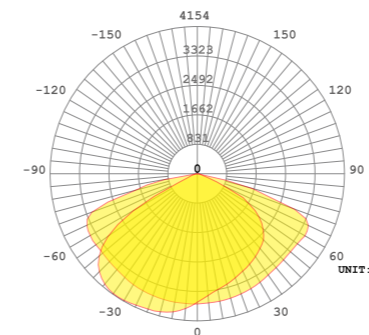

T2M

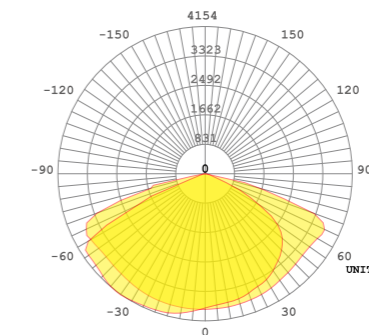

T3M

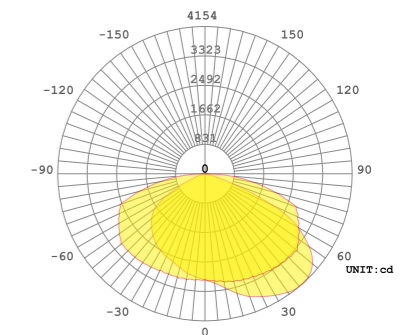

T4M



PRO SERIES LED POST TOP LIGHT

The Pro Post Top Fixture provides high quality illumination ideal for outdoor locations requiring energy-savings and a long life which is great for both security and decorative post top lighting for commercial applications such as parking lots or large walkways or parks.

TECHNICAL PARAMETERS

Light Source	OSRAM 2835
IP Rating	IP65
Input Voltage	100-277VAC / 347-480VAC
CCT	3000K/4000K/5000K/5700K/6500K
CRI	>80
Beam Angle	120°
Lifetime	50,000+ hours
Arm Dia	76mm / 3"

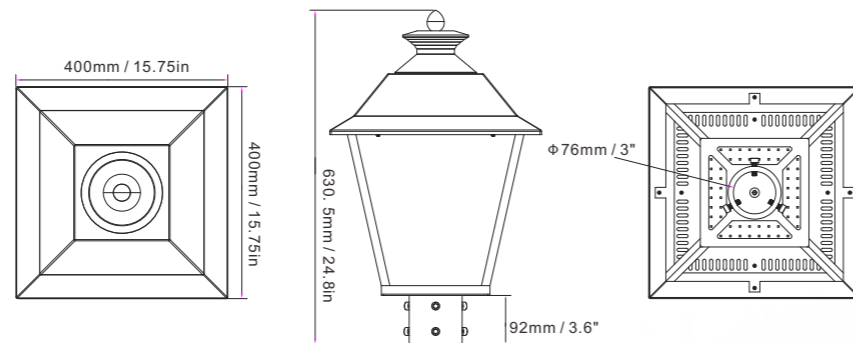

SPECIFICATIONS INFORMATION

Model	Watt	Input Voltage	Efficiency	Lumen	Driver
LSPT-20W(XXK)PRO	20W	100-277VAC	140LM/W±3%	2,800Lm	SS-30VA-56
LSPT-30W(XXK)PRO	30W	100-277VAC	140LM/W±3%	4,200Lm	SS-30VA-56
LSPT-40W(XXK)PRO	40W	100-277VAC	135LM/W±3%	5,400Lm	SS-50VA-56
LSPT-50W(XXK)PRO	50W	100-277VAC	135LM/W±3%	6,750Lm	SS-50VA-56
LSPT-60W(XXK)PRO	60W	100-277VAC	135LM/W±3%	7,800Lm	SS-60H-54

PRO

LED POST TOP LIGHT FIXTURES

Led Post Top Pole Lights LED Circular Area Light 20W-60W,Outdoor Lamp Top Pathway Pole Light Fixture for School Street Garden Yard Commercial Area Light,An IP65 Rating for Water-Resistance Our LED post-top/garden light being IP65 rated is protected against dust and moisture (or water from a nozzle), making the lighting fixture suitable to damp locations.



Green



Grey



Black



Dusk To Dawn Sensor

Our LED post-top/garden light comes with an inbuilt photocell or dusk to dawn sensor, when the primary role of any photocell sensor is to get turned OFF after detecting an ambient light while getting turned ON during darkness. That is why this post-top/garden light is known as dusk to dawn sensor light.

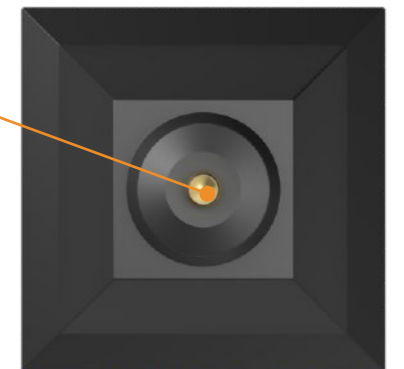

Arm Dia 76mm / 3"

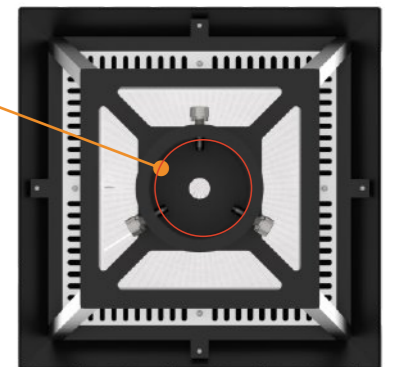



SHOEBOX SERIES AREA LIGHTS | LED PARKING LOT LIGHTS

- Optional photocontrol sensor for dusk to dawn operation
- LED pole light has standard arm mount for square and round poles
- Instant start, no flickering, no humming
- Low profile, corrosion resistant, heavy duty die-cast aluminum housing
- IP65 rated housing
- UV-resistant, multi-layer, architectural color, bronze powder coat finish
- Straight Pole Arm, Round Pole Mount, Slip fitter or Wall Mount.
- 5 years warranty

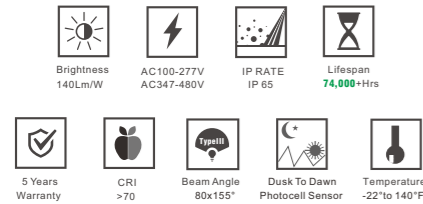

TECHNICAL PARAMETERS

Light Source	CREE 3030
Power Factor	>0.95
Input Voltage	100-277VAC / 347-480VAC
CCT	3000K/4000K/5000K/5700K/6500K
IP Rating	IP65
Beam Angle	80x155°(TypeIII)
Lifetime	74,000+ hours
Certificate	ETL cETL DLC Premium CE RoHS

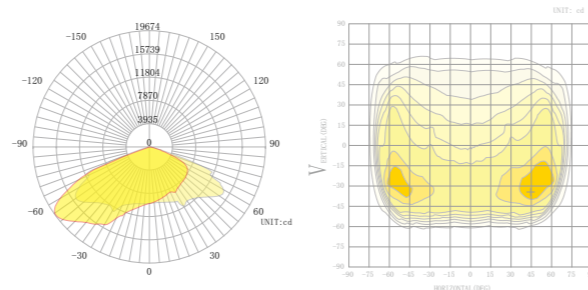

SPECIFICATIONS INFORMATION

Model	Watt	Input Voltage	Efficiency	Lumen	Driver	Dimensions (in)
LSSB-100W-LV(XXK)	100W	100-277VAC	130LM/W±3%	13,000Lm	ELG-100-48A	18.97**12.83**3.15"
LSSB-150W-LV(XXK)	150W	100-277VAC	130LM/W±3%	19,500Lm	ELG-150-48A	20.35**16.0**3.15"
LSSB-300W-LV(XXK)	300W	100-277VAC	130LM/W±3%	39,000Lm	ELG-100-48A	26.14**16.0**3.15"
LSSB-100W-HV(XXK)	100W	347-480VAC	130LM/W±3%	13,000Lm	FD-100V-50	18.97**12.83**3.15"
LSSB-150W-HV(XXK)	150W	347-480VAC	130LM/W±3%	19,500Lm	FD-150V-50	20.35**16.0**3.15"
LSSB-300W-HV(XXK)	300W	347-480VAC	130LM/W±3%	39,000Lm	2*FD-150V-50	26.14**16.0**3.15"



HEXAGON SERIES LED PARKING LOT RETROFIT KITS

- With a big Sunon fan.
- With beam angle 120 degree.
- Original super bright 3030 LED
- Arm adjustable with any beam angle.
- With the most excellent quality meanwell driver.
- Available for street light fixtures application.
- Using aluminum fin heat sink which heat transfer faster than die cast.

TECHNICAL PARAMETERS

Light Source	Lumileds SMD 3030
Power Factor	>0.95
Input Voltage	100-277VAC / 347-480VAC
CCT	3000K/4000K/5000K/5700K/6500K
IP Rating	IP65
Beam Angle	120°
Lifetime	50,000+ hours
Certificate	ETL cETL CE RoHS

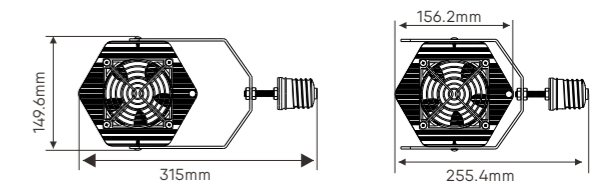
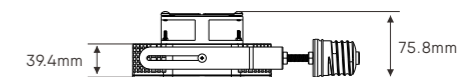
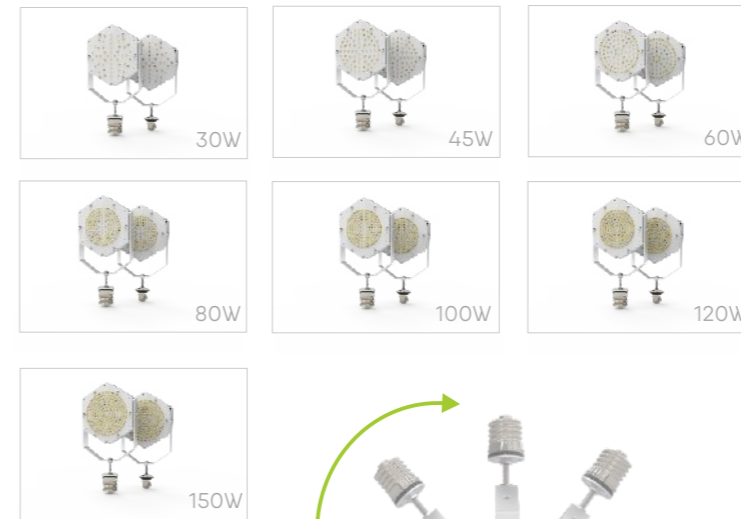

SPECIFICATIONS INFORMATION

Model	Watt	Input Voltage	Efficiency	Lumen	Driver	Replacement
LSRK-30WXY	30W	100-277VAC	130LM/W±3%	4,300Lm	FD-36H-038	75-105W MH HPS
LSRK-45WXY	45W	100-277VAC	130LM/W±3%	6,480Lm	FD-55H-038	105-125W MH HPS
LSRK-60WXY	60W	100-277VAC	130LM/W±3%	8,640Lm	FD-80H-038	150-175W MH HPS
LSRK-80WXY	80W	100-277VAC	130LM/W±3%	11,520Lm	ELG-100-48A	250-275W MH HPS
LSRK-100WXY	100W	100-277VAC	130LM/W±3%	14,400Lm	ELG-100-48A	300-350W MH HPS
LSRK-120WXY	120W	100-277VAC	130LM/W±3%	15,600Lm	ELG-150-48A	350-400W MH HPS
LSRK-150WXY	150W	100-277VAC	130LM/W±3%	21,000Lm	ELG-150-48A	450-500W MH HPS





LINEAR SERIES LINEAR LED HIGH BAY LIGHT FIXTURES

- Original Philips SMD 3030 which up to 120Lm/W.
- They are assembled by module light weight aluminum fin.
- IP65 waterproof ,dust-proof ,explosion-proof and anti-corrosion.
- Using aluminum fin heat sink which heat transfer faster than die cast.
- Tiny package and lighter,lower freight cost,more competitive in the market.
- UV-resistant, multi-layer, architectural color, bronze powder coat finish.
- Available for warehouse,advertisement ,gas station and factory lighting etc.
- 5 years warranty



TECHNICAL PARAMETERS

Light Source	Osram 2835
Efficiency	160lm/w
Input Voltage	100-277VAC / 347-480VAC
CCT	3000K/4000K/5000K/5700K/6500K
IP Rating	IP65
Beam Angle	60° / 90° / 120° (Symmetrical Angle)
Beam Angle	30x70° / 90x140° / 80x155° (Polarization Angle)
Certificate	TUV CE RoHS ETL DLC



Grey

Sandy Black

SPECIFICATIONS INFORMATION

Model	Watt	Input Voltage	Efficiency	Lumen	Driver	Dimensions (in)
LSLHBL-50W	50W	100-277VAC	160LM/W±3%	8,000Lm	SS-50VA-56	13.90* 4.53* 5.67
LSLHBL-100W	100W	100-277VAC	160LM/W±3%	16,000Lm	XLG-100-H-A	24.41* 4.53* 5.67
LSLHBL-150W	150W	100-277VAC	160LM/W±3%	24,000Lm	XLG-150-H-A	34.92* 4.53* 5.67
LSLHBL-200W	200W	100-277VAC	160LM/W±3%	32,000Lm	XLG-240-H-A	45.43 * 4.53 * 5.67
LSLHBL-240W	240W	100-277VAC	160LM/W±3%	38,400Lm	XLG-240-H-A	55.94 * 4.53 * 5.67



Our adjustable LED wall pack allows to adjust the angle of the fixture to illuminate a specific area without having to change the area or the base of the fixture.

WALL PACK SERIES

SEMI-CUTOFF / FULL-CUTOFF LED WALL PACK LIGHTS

- Die Cast Aluminum Housing.
- Sealed, corrosion-resistant.
- die-cast aluminum enclosure
- IP65 waterproof enclosure rating.
- Glare free, uniform lighting.
- Easy installation and operation.
- Instant on-no flickering or humming.
- 5-year warranty.

Full-cutoff



Semi-cutoff



TECHNICAL PARAMETERS

Light Source	Lumileds SMD 3030
Power Factor	>0.95
Input Voltage	100-277VAC / 347-480VAC
CCT	3000K/4000K/5000K/5700K/6500K
IP Rating	IP65
Photocell	Photo Cell (Optional)
Lifetime	50,000+ hours
Certificate	CE RoHS ETL DLC

SPECIFICATIONS INFORMATION

Model	Watt	Input Voltage	Efficiency	Lumen	Replacement	Dimensions (in)
LSSWP-40W	40W	100-277VAC	120LM/W±3%	4,800Lm	150-175W MH HPS	14.21x9.25x7.36
LSSWP-60W	60W	100-277VAC	120LM/W±3%	7,200Lm	200-250W MH HPS	14.21x9.25x7.36
LSSWP-75W	75W	100-277VAC	120LM/W±3%	9,000Lm	300W MH HPS	14.21x9.25x7.36
LSSWP-100W	100W	100-277VAC	120LM/W±3%	12,000Lm	400W MH HPS	14.21x9.25x7.36
LSFWP-25W	25W	100-277VAC	105LM/W±3%	2,600Lm	105W MH HPS	7.99x6.54x4.25
LSFWP-50W	50W	100-277VAC	115LM/W±3%	5,750Lm	150-175W MH HPS	11.42x9.45x6.22
LSFWP-75W	75W	100-277VAC	110LM/W±3%	8,400Lm	250W MH HPS	11.42x9.45x6.22





CORN SERIES LED RETROFIT LIGHT BULBS

- Long life span and less brightness degradation.
- Efficiency of power supply is more than 90%.
- No magnetic disturbance influence.
- No UV and near-IR radiation in the light beam.
- Driver is fulfilled with solid thermal grease.
- Free colorful inner box.
- Cooling fan built-in.
- 5 years warranty

TECHNICAL PARAMETERS

Light Source	SMD 2835
Base	E26 E27 E39 E40
Input Voltage	100-277VAC / 347-480VAC
CCT	3000K/4000K/5000K/5700K/6500K
CRI	>80
Beam Angle	360°
Lifetime	50,000+ hours
Certificate	ETL cETL DLC SAA CE RoHS



SPECIFICATIONS INFORMATION

Model	Watt	Input Voltage	Efficiency	Lumen	Replacement	Dimensions
LSCB-20WXY	20W	100-277VAC	130LM/W±3%	2,500Lm	75W MH HPS	Dia72*175mm
LSCB-30WXY	30W	100-277VAC	130LM/W±3%	3,750Lm	105W MH HPS	Dia72*200mm
LSCB-40WXY	40W	100-277VAC	130LM/W±3%	5,200Lm	125W MH HPS	Dia105*245mm
LSCB-40WXY-S	40W	100-277VAC	130LM/W±3%	5,200Lm	125W MH HPS	Dia105*185mm
LSCB-50WXY	50W	100-277VAC	130LM/W±3%	6,250Lm	150W MH HPS	Dia105*219mm
LSCB-60WXY	60W	100-277VAC	130LM/W±3%	7,800Lm	180W MH HPS	Dia105*255mm
LSCB-70WXY	70W	100-277VAC	130LM/W±3%	9,100Lm	250W MH HPS	Dia105*291mm
LSCB-100WXY	100W	100-277VAC	130LM/W±3%	13,000Lm	300W MH HPS	Dia128*287mm
LSCB-120WXY	120W	100-277VAC	130LM/W±3%	15,600Lm	350W MH HPS	Dia128*307mm
LSCB-150WXY	150W	100-277VAC	130LM/W±3%	19,500Lm	400W MH HPS	Dia128*337mm
LSCB-200WXY	200W	100-277VAC	130LM/W±3%	24,000Lm	500W MH HPS	Dia128*337mm
LSCB-240WXY	240W	100-277VAC	130LM/W±3%	28,000Lm	600W MH HPS	Dia128*357mm



GARDEN SERIES LED POST TOP GARDEN LIGHT

- 5 years warranty
- No camera flickering
- Photocell sensor available
- Available in tempered glass or LENS
- Long life span and less brightness degradation
- Efficiency of power supply is more than 90%.
- No UV and near-IR radiation in the light beam

TECHNICAL PARAMETERS

Light Source	Lumileds SMD 3030
Arm Diameter	2" & 3"
Input Voltage	100-277VAC / 347-480VAC
CCT	3000K/4000K/5000K/5700K/6500K
IP Rating	IP65
Beam Angle	60 / 90 / 120 degree
Lifetime	50,000+ hours
Certificate	ETL cETL DLC TUV CE RoHS SAA CB

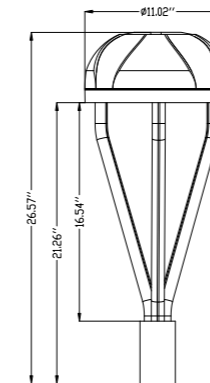
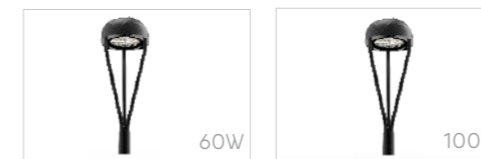

SPECIFICATIONS INFORMATION

Model	Watt	Input Voltage	Efficiency	Lumen	Driver	Replacement
LSPT-60W(XXK)	60W	100-277VAC	110LM/W±3%	6,600Lm	SS-60H-54	150W MH HPS
LSPT-100W(XXK)	100W	100-277VAC	110LM/W±3%	11,000Lm	ELG-100-48A	250W MH HPS

