

CONTACT

LAMP SHINING MANUFACTURING CO.,LTD



william@lampshining.com
sales@lampshining.com



0086-13612945445



0086-13612945445



0086-13612945445



lampshining87



www.lampshining.com



4th floor Building K Yuanling Zhixuanhan industrial Area Yuanmei
communityShiyan Town Bao'an District,Shenzhen China

ABOUT US

Lamp Shining Manufacturing Co.,Ltd was founded in 2010 who has been specializing in developping,manufacturing and selling LED lamps, we have won high reputation from our oversea clients.We have been focusing on the USA ,Europe and Australia markets. We are constantly developing and manufacturing new LED luminaires according to the needs of our customers and the needs of the environment, so we are always in the leading position in the industry.

2022-2023 Products Catalogs



**FUNCTIONAL,
RELIABLE,
FUTURE-PROOF**

Content

LED HIGH MAST LIGHT / STADIUM LIGHTING



P5-6
SLIM PRO
LED HIGH MAST LIGHTS



P7-8
SLIM PRO E
LED HIGH MAST LIGHTS



P9-10
SLIM PLUS
LED HIGH MAST LIGHTS



P10-12
SLIM MAX
LED HIGH MAST LIGHTS



P13-14
ALPHA
LED STADIUM LIGHTS



P15-16
DRAGONFLY
LED HIGH MAST LIGHTS



P17-18
DRAGONFLY MAX
LED STADIUM LIGHTS



P19-20
TRANSFORMER
LED HIGH MAST LIGHTS



P21-22
ULTRA
LED HIGH MAST LIGHTS



P23-24
ROUND
LED STADIUM LIGHTS

LED POST TOP LIGHTS



P25-26
SKYSCRAPER
LED POST TOP LIGHT



P27-28
SKYLINE
LED POST TOP LIGHT

LED STREET LIGHTS



P29-30
MARS
LED STREET LIGHTS



P31-34
PLUTO
LED STREET LIGHTS



P35-36
VENUS
LED STREET LIGHTS



P37-38
SATURN
LED STREET LIGHTS

LED HIGH BAY LIGHTS



P39-40
SLIM SERIES
UFO LED HIGH BAY LIGHT



P41-42
MOTION SENSOR
UFO LED HIGH BAY LIGHT



P43-44
LINEAR
LED HIGH BAY LIGHT

LED STREET LIGHTS



P45-46
NEMO
LED FLOOD LIGHTS



P47-48
NEMO EKO
LED FLOOD LIGHTS



P49-52
SLIM
LED FLOOD LIGHTS



P53-54
SLIM EKO
LED FLOOD LIGHTS

LED FIN MODULE LIGHT



P55-56
PRO E
LED FIN MODULE LIGHT



P57-58
PRO A
LED FIN MODULE LIGHT



P59-60
PRO B
LED FIN MODULE LIGHT



P61-62
PLUS
LED FIN MODULE LIGHT



P63-64
MAX
LED FIN MODULE LIGHT

LED SHOEBOX LIGHTS / PARKING LOT RETROFIT KITS / LED CORN BULBS



P65
SHOEBOX SERIES
LED SHOEBOX LIGHTS



P66
HEXAGON
LED PARKING LOT RETROFIT KITS



P67-68
ALUMINUM FINS
LED CORN BULBS

CERTIFICATION

LAMP SHINING[®]
WWW.LAMP SHINING.COM

Certification

We have certified DLC, ETL, TUV, SAA, CE, RoHS, ENEC, CB, IECEE, and more than 250 products have received DLC certification. The lighting efficiency is up to 160Lm/W. Suitable for the global lighting market.



EXHIBITION

Hong Kong Spring Lighting Fair



Hong Kong Autumn Lighting Fair



Panama Lighting Fair



SHIPMENT

Shipment



Fast



FAST DELIVERY

Customer satisfaction is our greatest pursuit

We have distributors in the US. Most products are made of semi-materials to meet the delivery time of fast production. We have 3 production lines with over 30 quality controls and workers to meet our fast delivery times and quality. Samples take 1-3 days, and bulk orders take only 10-15 days.



EXHIBITION



2018-2019 INTERNATIONAL LIGHT FAIR



SLIM PRO

LED HIGH MAST LIGHT & Flood Light

- Light Source: Lumileds 5050 • Housing: Marine grade aluminum • Input Volt: 100-277VAC / 374-480V
- Color Temp: 3000K 4000K 5000K 5700K • IK & IP RATING : IK10 IP66 • 5 years warranty
- Beam Angle: 10° 20° 40° 60° 90° 140°*100° 135x60°(P50) 140x25°(P65)

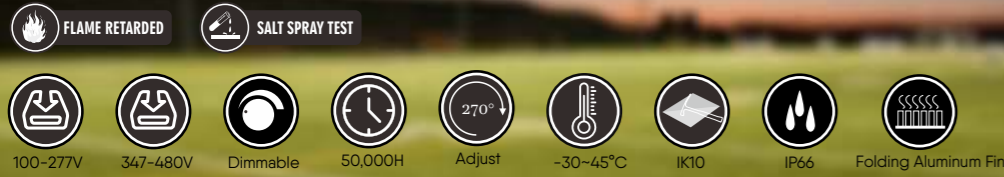

SLIM PRO

LED HIGH MAST LIGHT 100W-1440W

175 Lm/W

Folding Aluminum Fin
High pure thermal conductive module Folding Aluminum Fin Heat sink is made with high pressure Folding technology.

Professional optics
The optical lens is made of PC, and the transmittance reaches 92%, reducing light loss, maximize the lumens on where it should be lit up and evenness, minimize lighting pollution to nature and human life.

Module Rotatable
Module Rotatable ±25°, Separate module can be mounted on the same robust bracket to offer the utmost flexibility.

Installation Versatility
The fixing bracket is made of high-strength material and is bent at an angle of 45° to make the lamp body better installed.

5 Years Warranty **50000 Hour Long Service Life**

Model None Rotatable **Module Rotatable ±25°**

- All Applications**

 - Uniformity and light quality
 - Light pollution and spillage
 - Controls

Baseball, Softball

 - High levels of illumination
 - Lighted from all sides
 - Reducing glare

Harbors, Wharfs

 - Pole location (primarily sidelines)
 - Pole quantity
 - Number of fixtures per pole

Soccer, Lacrosse, Mixed Use

 - Pole location
 - Pole quantity
 - Number of fixtures per pole

Basketball, Tennis

 - Floodlight, or area-style fixtures
 - Court configuration (grouping)
 - Court access

Model	Watt	Lumen	Efficiency	Input Volt	Size	Driver	Weight
LSHM-100W-LV(XXX)	100W	16,000Lm	160lm/w±3%	100-277Vac	297x263x132mm	XLG-100-H-A	2.2kg
		17,500Lm	175lm/w±3%			XLG-150-H-A	
LSHM-120W-LV(XXX)	120W	18,600Lm	155lm/w±3%	100-277Vac	297x263x132mm	XLG-100-H-A	
		20,400Lm	170lm/w±3%			XLG-150-H-A	
LSHM-200W-LV(XXX)	200W	32,000Lm	160lm/w±3%	100-277Vac	342x362x132mm	XLG-240-H-A	5.5kg
		35,000Lm	175lm/w±3%			XLG-240-H-A	
LSHM-240W-LV(XXX)	240W	37,200Lm	155lm/w±3%	100-277Vac	342x362x132mm	XLG-240-H-A	
		40,800Lm	170lm/w±3%			XLG-240-H-A	
LSHM-300W-LV(XXX)	300W	48,000Lm	160lm/w±3%	100-277Vac	475x362x132mm	ELGC-300-H-A	7.5kg
		52,500Lm	175lm/w±3%			ELGC-300-H-A	
LSHM-400W-LV(XXX)	400W	64,000Lm	160lm/w±3%	100-277Vac	597x362x132mm	2pcs XLG-240-H-A	10kg
		70,000Lm	175lm/w±3%				
LSHM-480W-LV(XXX)	480W	74,400Lm	155lm/w±3%	100-277Vac	597x362x132mm	2pcs XLG-240-H-A	10kg
		81,600Lm	170lm/w±3%				
LSHM-B400W-LV(XXX)	400W	64,000Lm	160lm/w±3%	100-277Vac	529x362x188mm	2pcs XLG-240-H-A	10kg
		70,000Lm	175lm/w±3%				
LSHM-B480W-LV(XXX)	480W	74,400Lm	155lm/w±3%	100-277Vac	529x362x188mm	2pcs XLG-240-H-A	10kg
		81,600Lm	170lm/w±3%				
LSHM-B600W-LV(XXX)	600W	96,000Lm	160lm/w±3%	100-277Vac	649x375x188mm	3pcs XLG-240-H-A	12.5kg
		105,000Lm	175lm/w±3%				
LSHM-B720W-LV(XXX)	720W	111,600Lm	155lm/w±3%	100-277Vac	649x375x188mm	3pcs XLG-240-H-A	12.5kg
		122,400Lm	170lm/w±3%				
LSHM-B800W-LV(XXX)	800W	128,000Lm	160lm/w±3%	100-277Vac	650x597x188mm	4pcs XLG-240-H-A	16kg
		140,000Lm	175lm/w±3%				
LSHM-B1000W-LV(XXX)	1000W	160,000Lm	160lm/w±3%	100-277Vac	650x597x188mm	4pcs XLG-240-H-A	16kg
		175,000Lm	175lm/w±3%				
LSHM-B1200W-LV(XXX)	1200W	192,000Lm	160lm/w±3%	100-277Vac	729x650x188mm	5pcs XLG-240-H-A	20kg
		204,000Lm	170lm/w±3%				
LSHM-B1440W-LV(XXX)	1440W	230,400Lm	160lm/w±3%	100-277Vac	860x650x188mm	6pcs XLG-240-H-A	22kg
		244,800Lm	170lm/w±3%				

Beam Angle

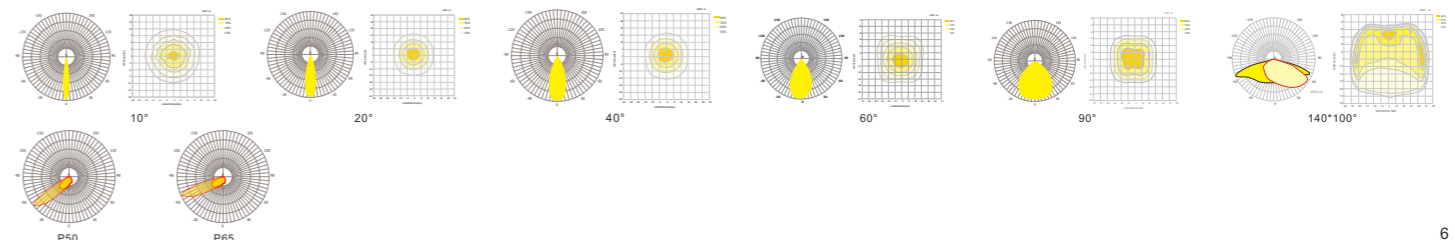

170 Lm/W



SLIM PROE
LED FLOOD LIGHT 50W-240W



50W

100W

150W

200W

240W



PRO E

Slim ProE LED Flood Light

140LM/W 170LM/W

50W 100W 150W 200W 240W

Folding Aluminum fin design which are very light weight. Increase the heat dissipation surface area by air cooling to dissipate heat and expand the contact area with air! It speeds up the spread of heat! Thermal effect is good!



PRO E
LED FIN MODULE LIGHT
FOLDING ALUMINUM FIN DESIGN

- Light Source: Luminleds 3030
- Input Volt: 100-277Vac
- IP Rating IK Rating : IP66 & IK10
- Beam Angle: 15° 25° 40° 60° 90° 120°
30x70° 49x21° 136x78°
- Color Temp: 3000K 4000K 5000K 5700K 6000K
- 5 years warranty

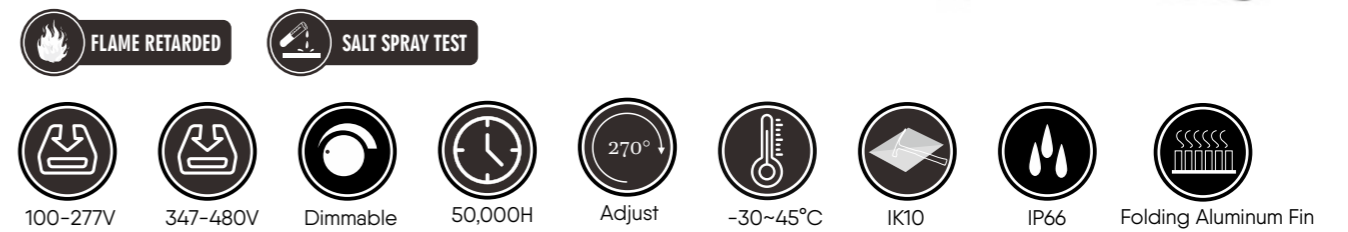

Technical Specifications

Model	Watt	Efficiency #1	Lumen #1	Efficiency #2	Lumen #2	Driver	Net Weight
LSHM-50W-LV(XXX)ProE	50W	140LM/W±3%	7,000Lm	170LM/W±3%	8,500Lm	SS-50VA-56	1.4kg
LSHM-100W-LV(XXX)ProE	100W	140LM/W±3%	14,000Lm	170LM/W±3%	17,000Lm	XLG-100-H-A	2.7KG
LSHM-150W-LV(XXX)ProE	150W	140LM/W±3%	21,000Lm	170LM/W±3%	25,500Lm	XLG-150-H-A	3.5KG
LSHM-200W-LV(XXX)ProE	200W	140LM/W±3%	28,000Lm	170LM/W±3%	34,000Lm	XLG-240-H-A	4.2KG
LSHM-240W-LV(XXX)ProE	240W	140LM/W±3%	33,600Lm	170LM/W±3%	40,800Lm	XLG-240-H-A	4.8KG



Wall Installation



Ground Installation



Pole Installation

Beam Angle

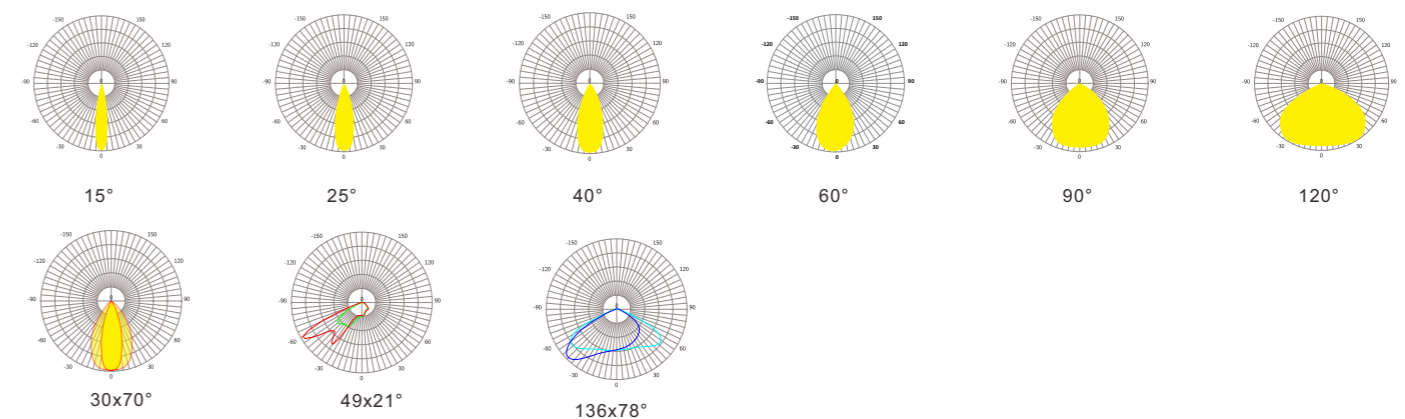

HOT

190 Lm/W

SLIM PLUS

LED HIGH MAST LIGHT 240W-1500W



SLIM PLUS

LED HIGH MAST LIGHT & Flood Light

- Light Source: Lumileds 5050
- Input Volt: 100-277VAC / 374-480V
- Module rotatable 270°
- IK & IP RATING : IK10 IP66
- Housing: Marine grade aluminum
- Color Temp: 3000K 4000K 5000K 5700K
- 5 years warranty



SLIM PLUS SERIES LED HIGH MAST LIGHT

Professional high mast light is required more and more for applications where not only lux on ground is asked, but also homogeneity, small beam angle multiple, lifetime, resistance are even more important. "Slim Plus" is the ideal solution.



All Applications

- Uniformity and light quality
- Light pollution and spillage
- Controls

Baseball, Softball

- High levels of illumination
- Lighted from all sides
- Reducing glare

Harbors, Wharfs

- Pole location (primarily sidelines)
- Pole quantity
- Number of fixtures per pole

Soccer, Lacrosse, Mixed Use

- Pole location
- Pole quantity
- Number of fixtures per pole

Basketball, Tennis

- Floodlight, or area-style fixtures
- Court configuration (grouping)
- Court access

5 Years Warranty
50000 Hour Long Service Life

Model	Model	Watt	Efficiency	Lumen	CCT	Driver	Weight
	LSHM-200W-LV(XXK)PLUS	200W	190lm/w±3%	38,000Lm	4000K 5000K	XLG-240-H-A	7.0KG
	LSHM-200W-LV(XXK)PLUS	200W	180lm/w±3%	36,000Lm		XLG-240-H-A	
	LSHM-240W-LV(XXK)PLUS	240W	170lm/w±3%	40,800Lm	3000K-6000K	XLG-240-H-A	7.5KG
	LSHM-300W-LV(XXK)PLUS	300W	160lm/w±3%	48,000Lm		ELGC-300-H-A	
	LSHM-400W-(XXK)PLUS	400W	190lm/w±3%	76,000Lm	4000K 5000K	2pcs ELG-240-48A	10KG
	LSHM-400W-(XXK)PLUS	400W	180lm/w±3%	72,000Lm		2pcs ELG-240-48A	
	LSHM-480W-(XXK)PLUS	480W	170lm/w±3%	81,600Lm	3000K-6000K	2pcs ELG-240-48A	11KG
	LSHM-600W-(XXK)PLUS	600W	160lm/w±3%	96,000Lm		2pcs ELGC-300-H-A	
	LSHM-600W-LV(XXK)PLUS-B	600W	190lm/w±3%	114,000Lm	4000K 5000K	3pcs ELG-240-48A	13KG
	LSHM-600W-LV(XXK)PLUS-B	600W	180lm/w±3%	108,000Lm		3pcs ELG-240-48A	
	LSHM-720W-LV(XXK)PLUS	720W	170lm/w±3%	112,400Lm	3000K-6000K	3pcs ELG-240-48A	14.5KG
	LSHM-900W-LV(XXK)PLUS	900W	160lm/w±3%	144,000Lm		3pcs ELGC-300-H-A	
	LSHM-800W-LV(XXK)PLUS	800W	190lm/w±3%	152,000Lm	4000K 5000K	4pcs ELG-240-48A	16KG
	LSHM-800W-LV(XXK)PLUS	800W	180lm/w±3%	144,000Lm		4pcs ELG-240-48A	
	LSHM-960W-LV(XXK)PLUS	960W	170lm/w±3%	163,200Lm	3000K-6000K	4pcs ELG-240-48A	18KG
	LSHM-1200W-LV(XXK)PLUS	1200W	160lm/w±3%	192,000Lm		4pcs ELGC-300-H-A	
	LSHM-1000W-LV(XXK)PLUS	1000W	190lm/w±3%	190,000Lm	4000K 5000K	5pcs ELG-240-48A	18KG
	LSHM-1000W-LV(XXK)PLUS	1000W	180lm/w±3%	180,000Lm	3000K-6000K	5pcs ELG-240-48A	
	LSHM-1500W-LV(XXK)PLUS	1500W	170lm/w±3%	255,500Lm		5pcs ELGC-300-H-A	22KG

Beam Angle

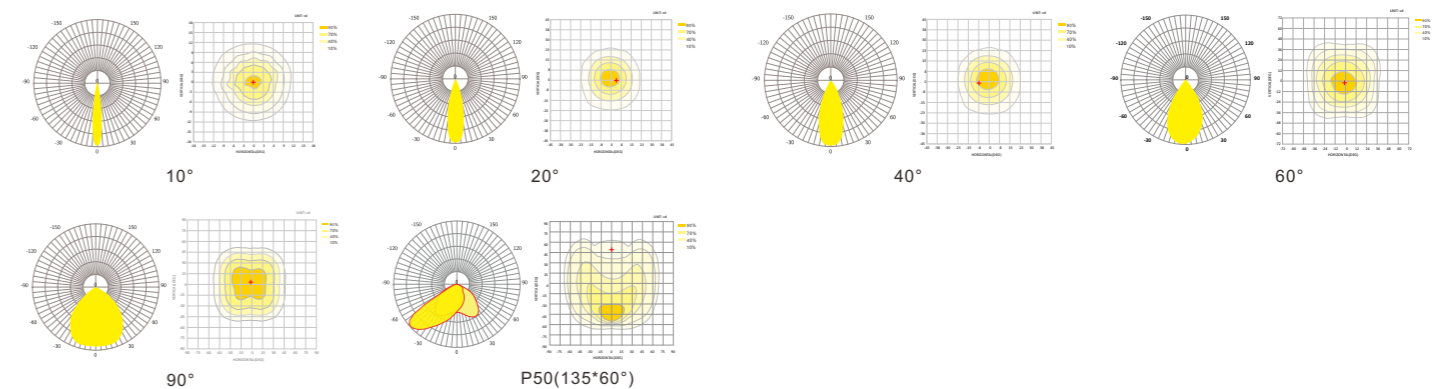

190 Lm/W

SLIM MAX

LED HIGH MAST LIGHT 240W-1500W

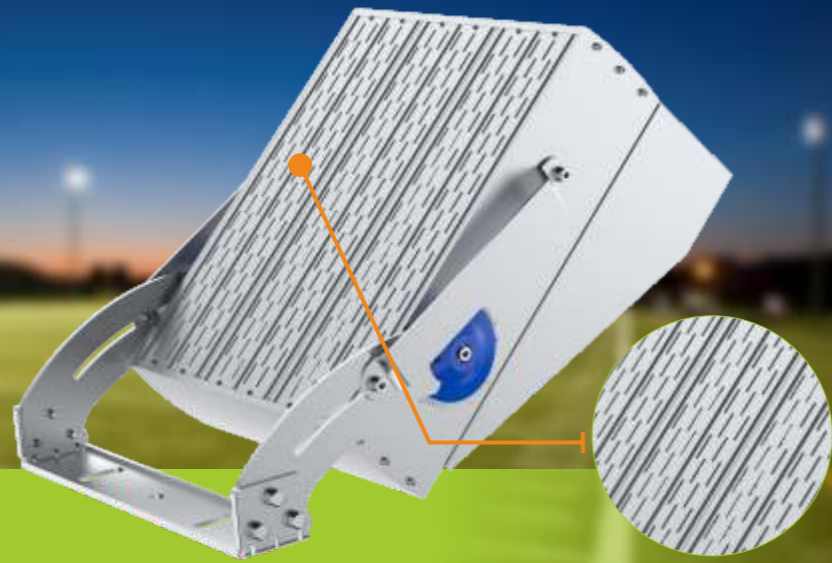

Dustproof Net Protect the lamp from other debris

SLIM MAX

LED HIGH MAST LIGHT & Flood Light

- Light Source: Lumileds 5050
- Input Volt: 100-277VAC / 374-480V
- Module rotatable 270°
- IK & IP RATING : IK10 IP66
- Housing: Marine grade aluminum
- Color Temp: 3000K 4000K 5000K 5700K
- 5 years warranty



FLAME RETARDED
 SALT SPRAY TEST
 100-277V
 374-480V
 Dimmable
 50,000H
 Adjust
 270°
 -30~45°C
 IK10
 IP66
 Folding Aluminum Fin

SLIM MAX SERIES LED HIGH MAST LIGHT

Slim MAX outdoor pole LED sport flood lighting fixtures replace traditional lighting fixtures and can immediately improve the quality of lighting in stadiums, large areas, roads, ports, and airports, and reduce energy consumption by as much as 75%.



Model	Watt	Efficiency	Lumen	Chip Brand	Dimensions (mm)	Weight
LSHM-200W-LV(XXK)MAX	200W	180LM/W±3%	40,800Lm	Luminleds 5050	185*648.3*147mm	9.5Kg
LSHM-240W-LV(XXK)MAX	240W	170LM/W±3%	40,800Lm	Luminleds 5050	185*648.3*147mm	9.5Kg
LSHM-300W-LV(XXK)MAX	300W	160LM/W±3%	48,000Lm	Luminleds 5050	185*648.3*147mm	10Kg
LSHM-400W-LV(XXK)MAX	400W	180LM/W±3%	81,600Lm	Luminleds 5050	372*744.6*147mm	14.5Kg
LSHM-480W-LV(XXK)MAX	480W	170LM/W±3%	81,600Lm	Luminleds 5050	372*744.6*147mm	14.5Kg
LSHM-600W-LV(XXK)MAX	600W	160LM/W±3%	96,000Lm	Luminleds 5050	372*744.6*147mm	15.5Kg
LSHM-720W-LV(XXK)MAX-B	600W	180LM/W±3%	122,400Lm	Luminleds 5050	520.5*744.6*147mm	18Kg
LSHM-720W-LV(XXK)MAX	720W	170LM/W±3%	122,400Lm	Luminleds 5050	520.5*744.6*147mm	18Kg
LSHM-900W-LV(XXK)MAX	900W	160LM/W±3%	144,000Lm	Luminleds 5050	520.5*744.6*147mm	19.5Kg
LSHM-800W-LV(XXK)MAX	800W	180LM/W±3%	144,000Lm	Luminleds 5050	668.6*744.6*147mm	22Kg
LSHM-960W-LV(XXK)MAX	960W	170LM/W±3%	163,200Lm	Luminleds 5050	668.6*744.6*147mm	22Kg
LSHM-1200W-LV(XXK)MAX	1200W	160LM/W±3%	192,000Lm	Luminleds 5050	668.6*744.6*147mm	24.5Kg
LSHM-1000W-LV(XXK)MAX	1000W	180LM/W±3%	180,000Lm	Luminleds 5050	819*744.6*147mm	29Kg
LSHM-1500W-LV(XXK)MAX	1500W	160LM/W±3%	240,000Lm	Luminleds 5050	819*744.6*147mm	29Kg

All Applications

- Uniformity and light quality
- Light pollution and spillage
- Controls

Baseball, Softball

- High levels of illumination
- Lighted from all sides
- Reducing glare

Harbors, Wharfs

- Pole location (primarily sidelines)
- Pole quantity
- Number of fixtures per pole

Soccer, Lacrosse, Mixed Use

- Pole location
- Pole quantity
- Number of fixtures per pole

Basketball, Tennis

- Floodlight, or area-style fixtures
- Court configuration (grouping)
- Court access



Beam Angle

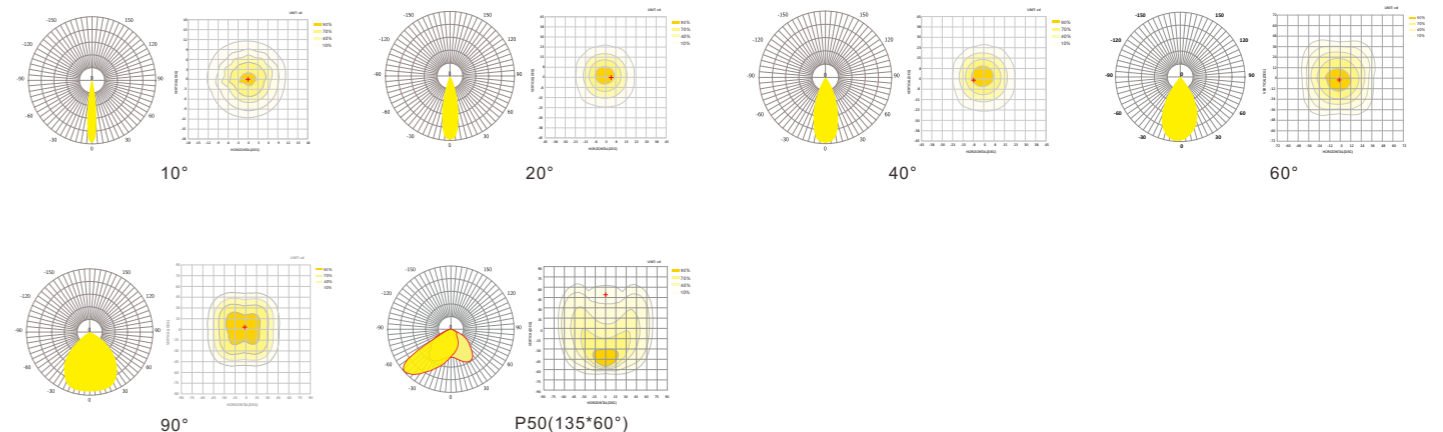

ALPHA

ANTI GLARED LED STADIUM FLOOD LIGHT

Features

170 Lm/W

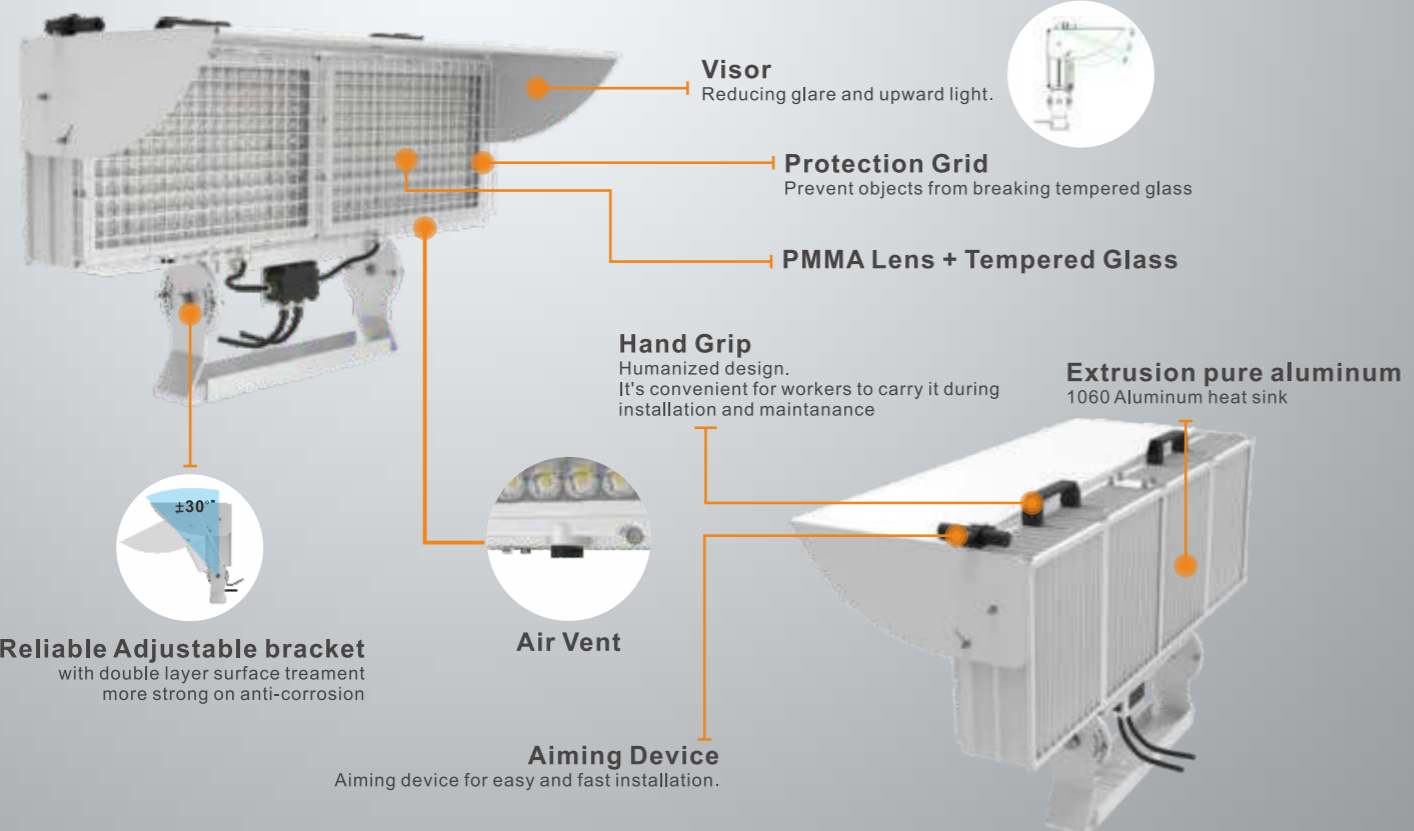
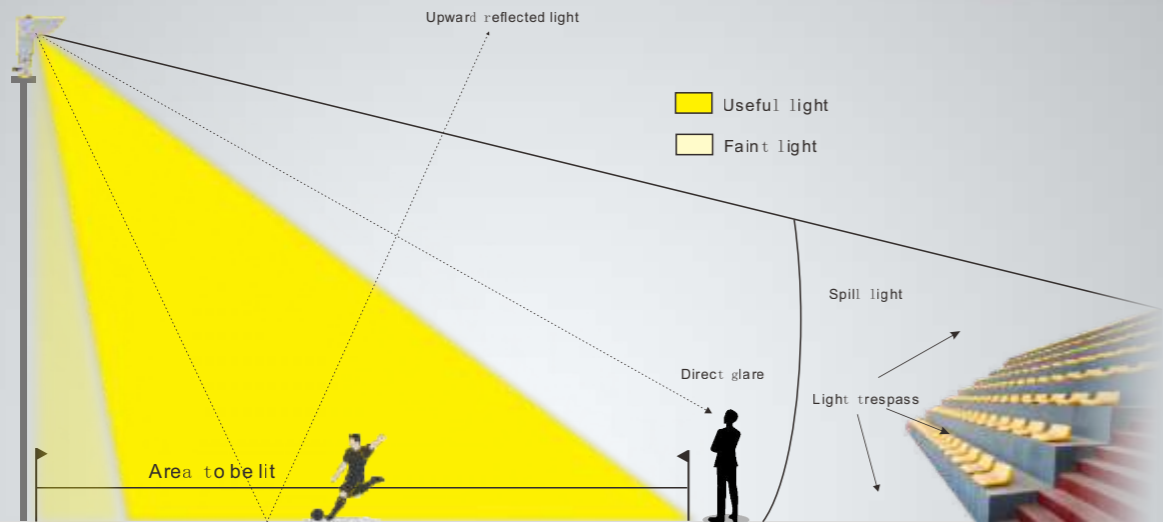

ALPHA

ANTI GLARED LED STADIUM FLOOD LIGHT

500W 600W 1000W 1200W

HOT

- Light Source: Lumileds 5050
- Input Volt: 176-305VAC
- IP & IK Rating : IP66 & IK08
- Dimmable: non-dimmable (Dimmable Optional)
- SPD: 10KV (20KV Optional)
- Beam Angle: P70 P45 30° 60° 90° T2M T3M
- Color Temp: 3000-6000K
- CRI: CRI>70 (CRI>80 optional)
- GR: <40
- Anti glared Visor: Rotatable
- Reflector driver box: External Driver Box & Internal driver



51.0-56.0m/s Wind load IP66 IK08 Light Weight Salt Spray Test 10KV 20KV China Patent design Europe Patent design

Model	Watt	Lumen	Efficiency	CCT	Size	Driver	Weight
LSASL-500W-LV(XXK)	500W	70,000Lm	140Lm/w±3%	3000-6000K	470x382x525mm	Inventronics EUD-600S280DV	16kg
		85,000Lm	170Lm/w±3%				
LSASL-600W-LV(XXK)	600W	81,000Lm	135Lm/w±3%	3000-6000K	470x382x525mm	Inventronics EUD-600S280DV	16kg
		99,000Lm	165Lm/w±3%				
LSASL-1000W-LV(XXK)	1000W	140,000Lm	140Lm/w±3%	3000-6000K	920x382x545mm	Inventronics EBM-1K2S740MG	28kg
		170,000Lm	170Lm/w±3%				
LSASL-1200W-LV(XXK)	1200W	162,000Lm	135Lm/w±3%	3000-6000K	920x382x545mm	Inventronics EBM-1K2S740MG	28kg
		198,000Lm	165Lm/w±3%				

Beam Angle

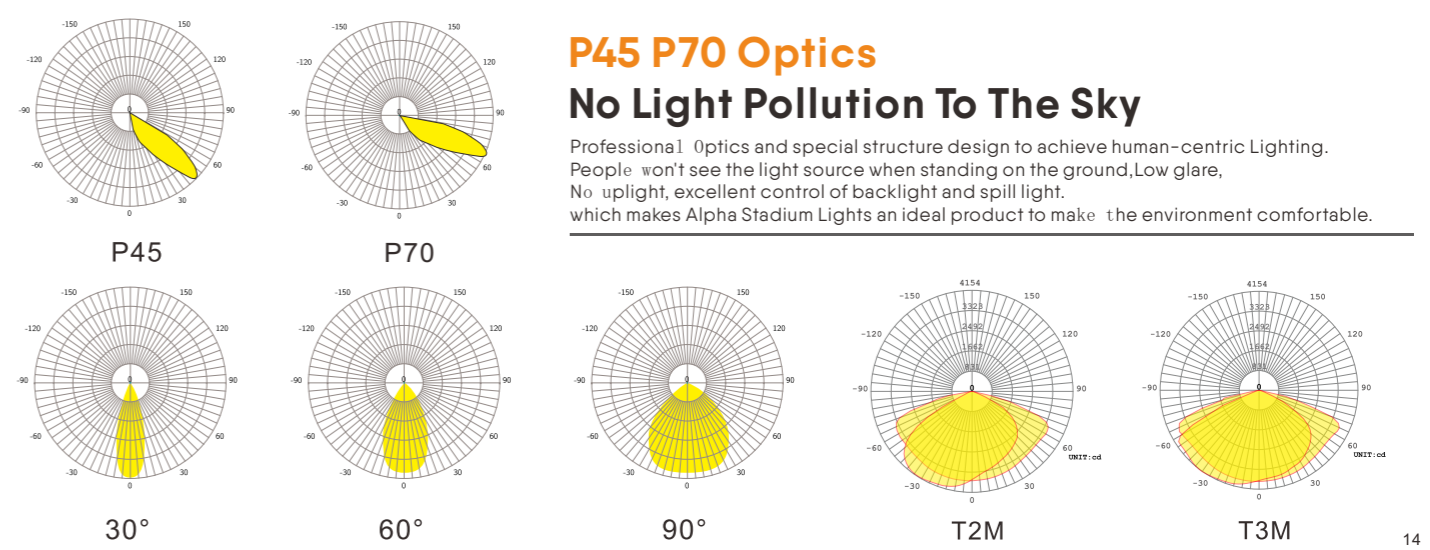

165 Lm/W

DRAGONFLY SERIES

LED SPORTS FLOODLIGHT HIGH MAST LIGHT



DRAGONFLY

LED SPORTS FLOODLIGHT HIGH MAST LIGHT

- Light Source: Lumileds 5050
- Input Volt: 100-277VAC
- modules are 360° rotatable, arm comes with scale plate.
- IK & IP Rating : IK08 IP66
- Wind rating: 51.0-56.0m/s
- CCT: 3000-6500K
- 5 years warranty



LIGHT WEIGHT FLODED FIN



240W / 300W



480W / 600W

▶ LIGHT WEIGHT

The advantage of aluminum fin heat dissipation is that the weight is reduced by about 30% to 40%. This is an advantage compared to traditional die-cast aluminum lamps for sports field lighting installations. To reduce the loading weight of the pole and to reduce the workload of the installer.



720W / 900W



960W / 1200W

▶ FLODED FIN

This allows you to improve thermal performance while adding a minimal amount of weight. Folded Fin heatsinks use a continuous strip of aluminum sheet metal affixed to an aluminum base plate. The advantage of Folded Fin as opposed to extruded heatsinks is higher aspect ratios and thinner fins, thus increasing surface area and lowering thermal resistance. The stamping riveting process is not welded so that it make the aluminum fins fit more closely with the aluminum board, creating more surface touching area from led chips heat to the heat sink and contributing to faster heat dissipation.



1440W / 1800W

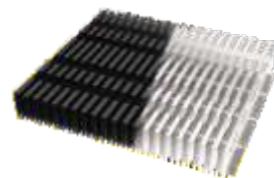

Model	Watt	Lumen	Efficiency	Input Volt	Size	Driver	Weight
LSDHM-B240W-LV(XXX)	240W	39,600Lm	165lm/w±3%	100-277Vac	544x253x126.5mm	XLG-240-H-A	8.9kg
LSDHM-B300W-LV(XXX)	300W	46,500Lm	155lm/w±3%	100-277Vac		ELGC-300-H-A	9.3kg
LSDHM-480W-LV(XXX)	480W	79,200Lm	165lm/w±3%	100-277Vac	685x553x173mm	2pcs XLG-240-H-A	16.2KG
LSDHM-600W-LV(XXX)	600W	93,000Lm	155lm/w±3%	100-277Vac		2pcs ELGC-300-H-A	17KG
LSDHM-720W-LV(XXX)	720W	118,800Lm	165lm/w±3%	100-277Vac	685x853x172mm	3pcs XLG-240-H-A	22.8KG
LSDHM-900W-LV(XXX)	900W	139,500Lm	155lm/w±3%	100-277Vac		3pcs ELGC-300-H-A	24KG
LSDHM-960W-LV(XXX)	960W	158,400Lm	165lm/w±3%	100-277Vac	999.7x923x221.2mm	4pcs XLG-240-H-A	30.4KG
LSDHM-1200W-LV(XXX)	1200W	186,00Lm	155lm/w±3%	100-277Vac		4pcs ELGC-300-H-A	32kg
LSDHM-1440W-LV(XXX)	1440W	237,600Lm	165lm/w±3%	100-277Vac	1319.7x923x221.2mm	6pcs XLG-240-H-A	39.6kg
LSDHM-1800W-LV(XXX)	1800W	279,000Lm	155lm/w±3%	100-277Vac		6pcs ELGC-300-H-A	42kg

Beam Angle

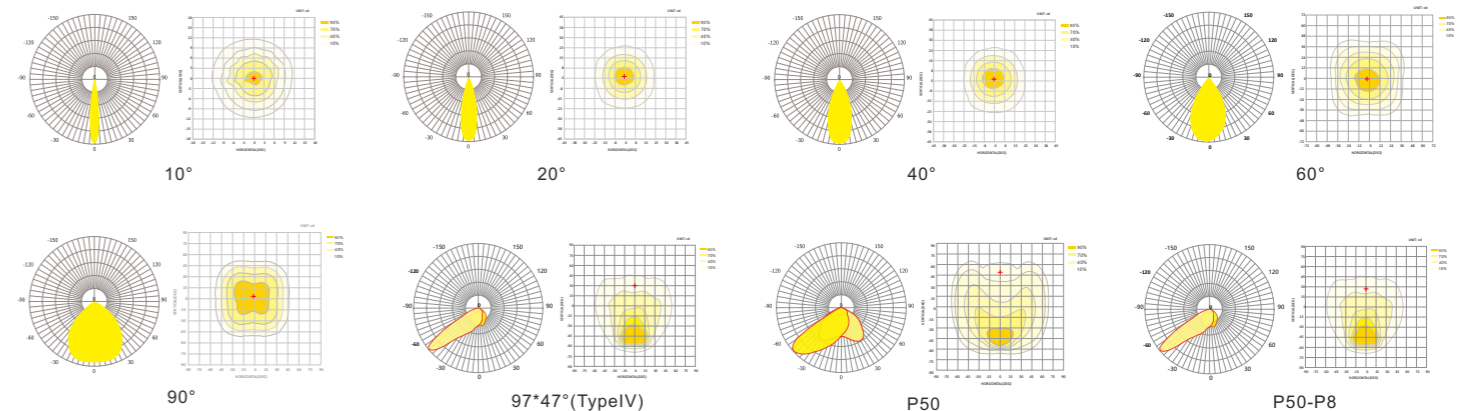

DRAGONFLY MAX

LED HIGH MAST FLOOD LIGHTING

Features



Light Weight



Modular



10KV 20KV



51.0-56.0m/s
Wind load



IP66



IK10

CB LM79 LM80 TM21

180 Lm/W



Visor
Reducing glare and upward light

5 Years Warranty
50000 Hour Long Service Life



Module fixing buckle

The fixed buckle of the module is made of stainless steel and the left and right direction of the module can be adjusted by $\pm 45^\circ$



Breathable Protective Air Vent Plug

Each Module of comes with Waterproof Breathable Pressure Relief Vent Plug

Tool-free for adjustment

Knob fixing which is for tool-free adjustment of module angle $\pm 45^\circ$

Pure aluminum heat sink

pure aluminum body with strong anticorrosion performance and excellent heat dissipation ability.

Driver box is separable

The module is separated from the driver, and the driver box can be installed separately under the light pole for easy maintenance in the future days. Drivers and modules come with female/male connectors

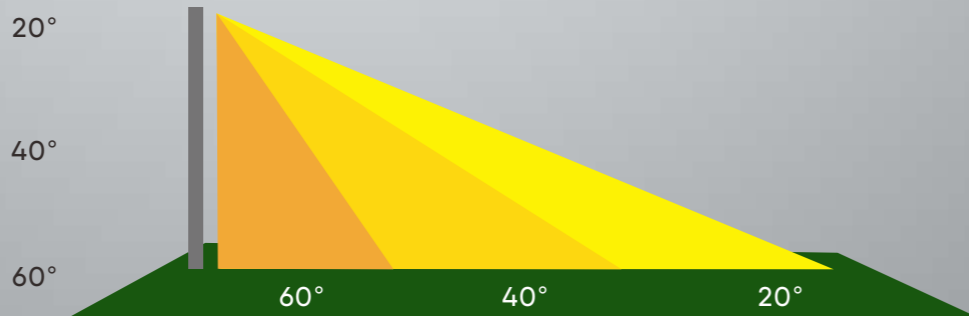

DRAGONFLY MAX

LED HIGH MAST LIGHTS

- Light Source: Lumileds 5050 / Osram 5050
- Input Volt: 100-277VAC / 347-480VAC
- IP & IK Rating : IP66 & IK10
- Dimmable: 1-10V
- SPD: 10KV / 20KV
- Beam Angle: 20° 40° 60°
- Color Temp: 3000K 4000K 5000K 5700K 6000K
- 5 years warranty



FLAME RETARDED
 SALT SPRAY TEST

100-277V
 347-480V
 Dimmable
 50,000H
 Adjust
 270°
 -30~45°C
 IK10
 IP66
 Folding Aluminum Fin

Model	Watt	Efficiency	Lumen	Driver	Size (L x W x H)	Weight
LSDHM-240W-LV(XXX)MAX	240W	180lm/w $\pm 3\%$	43,200Lm	ELG-240-48A	381.5x300x120mm	4.2Kg
LSDHM-300W-LV(XXX)MAX	300W	170lm/w $\pm 3\%$	51,000Lm	ELGC-300-H-A	381.5x300x120mm	4.2Kg
LSDHM-480W-LV(XXX)MAX	480W	180lm/w $\pm 3\%$	86,400Lm	2 x ELG-240-48A	420x787x540mm	14.5KG
LSDHM-600W-LV(XXX)MAX	600W	170lm/w $\pm 3\%$	102,000Lm	2 x ELGC-300-H-A	420x787x540mm	15KG
LSDHM-720W-LV(XXX)MAX	720W	180lm/w $\pm 3\%$	129,600Lm	3 x ELG-240-48A	420x960x754.5mm	19.5KG
LSDHM-900W-LV(XXX)MAX	900W	170lm/w $\pm 3\%$	153,000Lm	3 x ELGC-300-H-A	420x960x754.5mm	20.5KG
LSDHM-960W-LV(XXX)MAX	960W	180lm/w $\pm 3\%$	172,800Lm	4 x ELG-240-48A	818.5x788x555mm	25.5KG
LSDHM-1200W-LV(XXX)MAX	1200W	170lm/w $\pm 3\%$	204,000Lm	4 x ELGC-300-H-A	818.5x788x555mm	26.5KG
LSDHM-1440W-LV(XXX)MAX	1440W	180lm/w $\pm 3\%$	259,200Lm	6 x ELG-240-48A	818.5x962x785mm	34.5KG
LSDHM-1800W-LV(XXX)MAX	1800W	170lm/w $\pm 3\%$	306,000Lm	6 x ELGC-300-H-A	818.5x962x785mm	36.5KG

Model	Watt	Efficiency	Lumen	Driver	Size (L x W x H)	Weight
LSDHM-200W-LV(XXX)MAX	200W	200lm/w $\pm 3\%$	40,000Lm	ELG-240-48A	381.5x300x120mm	4.2Kg
LSDHM-400W-LV(XXX)MAX	400W	200lm/w $\pm 3\%$	80,000Lm	2 x ELG-240-48A	420x787x540mm	14.5KG
LSDHM-600W-LV(XXX)MAX-C	600W	200lm/w $\pm 3\%$	120,000Lm	3 x ELGC-300-H-A	420x960x754.5mm	19.5KG
LSDHM-800W-LV(XXX)MAX	800W	200lm/w $\pm 3\%$	160,000Lm	4 x ELG-240-48A	818.5x788x555mm	25.5KG
LSDHM-1200W-LV(XXX)MAX-C	1200W	200lm/w $\pm 3\%$	240,000Lm	6 x ELGC-300-H-A	818.5x962x785mm	34.5KG

Beam Angle

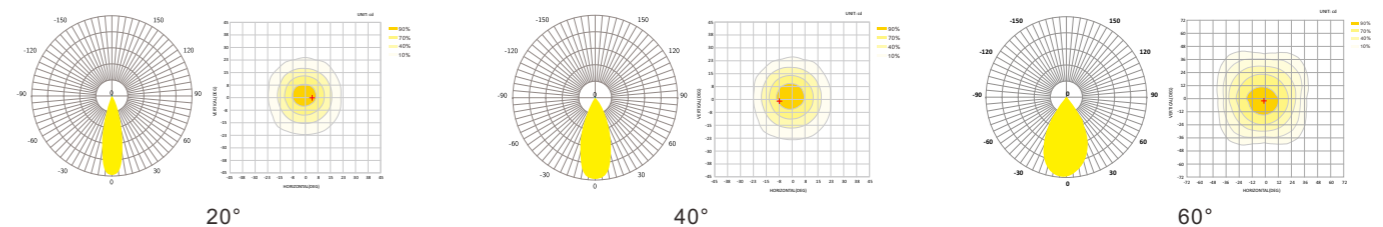



165 Lm/W

TRANSFORMES SERIES
LED HIGH MAST LIGHT 600W-1440W

TRANSFORMER

LED HIGH MAST LIGHTS

- Light Source: Lumileds 5050
- Input Volt: 100-277VAC
- Module rotatable up & down 360°
- IK & IP Rating : IK10 IP65
- Housing: Marine grade aluminum
- Color Temp: 3000K 4000K 5000K 5700K
- 5 years warranty



Rotatable 100-277V 50,000H Dimmable -30~45°C IK08 IP65

LIGHT WEIGHT FLODED FIN

5 Years Warranty 50000 Hour Long Service Life

600W / 720W 800W / 960W 1000W/1200W 1440W

Model	Watt	Efficiency	Lumen	Driver	Dimensions (mm)	Net weight
LSTHM-B600W-LV(XXX)	600W	160LM/W±3%	96,000Lm	SS-100VA-56	723*694*268	23Kg
LSTHM-B720W-LV(XXX)	720W	155LM/W±3%	111,600Lm	SS-150VA-56	723*694*268	23Kg
LSTHM-B800W-LV(XXX)	800W	160LM/W±3%	128,000Lm	SS-200VA-56	597*650*132	27Kg
LSTHM-B960W-LV(XXX)	960W	155LM/W±3%	148,800Lm	SS-240VA-56	597*650*132	27Kg
LSTHM-B1000W-LV(XXX)	1000W	160LM/W±3%	160,000Lm	SS-320V-54	729*650*132	31.5Kg
LSTHM-B1200W-LV(XXX)	1200W	155LM/W±3%	186,000Lm	2*SS-200VA-56	729*650*132	31.5Kg
LSTHM-B1440W-LV(XXX)	1440W	160LM/W±3%	230,400Lm	2*SS-240VA-56	860*650*132	37Kg

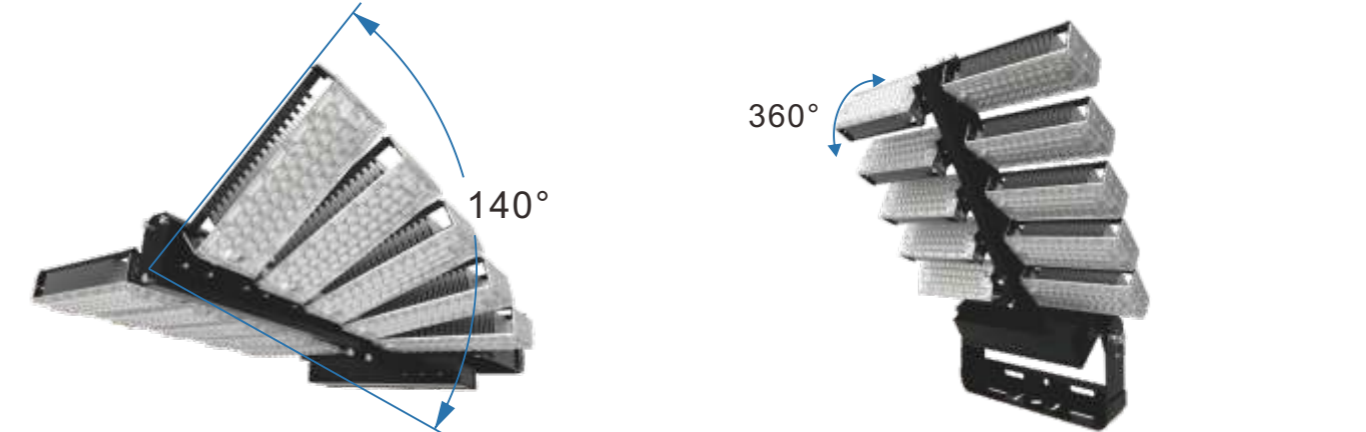

All Applications
• Uniformity and light quality
• Light pollution and spillage
• Controls

Soccer, Lacrosse, Mixed Use
• Pole location
• Pole quantity
• Number of fixtures per pole

Baseball, Softball
• High levels of illumination
• Lighted from all sides
• Reducing glare

Basketball, Tennis
• Floodlight, or area-style fixtures
• Court configuration (grouping)
• Court access

Harbors, Wharfs
• Pole location (primarily sidelines)
• Pole quantity
• Number of fixtures per pole

Beam Angle

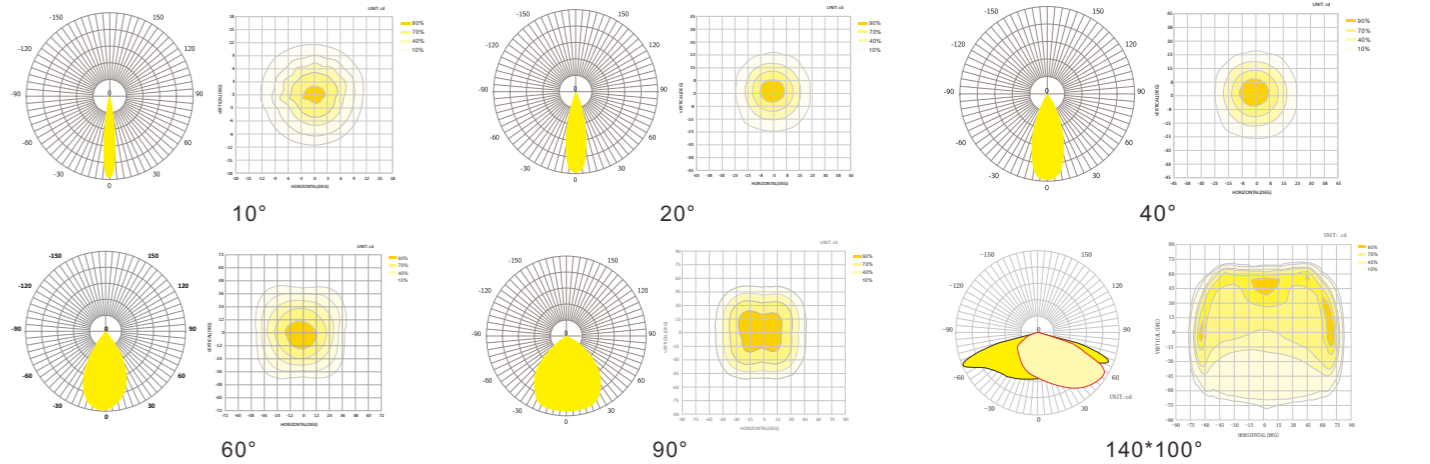

Intertek 5000190 TÜV CE RoHS SAA APPROVALS CB LM79 LM80 IEC60598-2 IP66 spray test



190 Lm/W

ULTRA SERIES
LED HIGH MAST LIGHT 480W-1800W

ULTRA SERIES LED SPORTS LIGHT

The Ultra series of LED high- mast lights are sturdy and durable with integrated aluminum alloy die-casting honeycomb heat dissipation design. And the surface has adopted black sand powder spray treatment, corrosion resistance oxidation resistance, and salt spray resistance. What's more, it uses the stainless steel bracket and Silicone gaskets and the screws are made of AISI 304 stainless steel.



HIGH LUMINOUS EFFICIENCY

The Ultra series led high-pole floodlights are aimed at the application needs of large area lighting. The Ultra series flood lights can be expanded from 480W to 1800W, with a luminous effect of up to 190LM/W and it can be used in various beam angle degree for the different area lighting requirements to achieve better lighting effects.

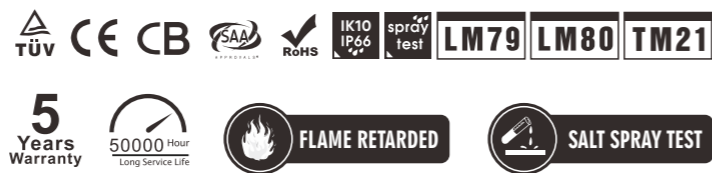

ULTRA
LED HIGH MAST LIGHTS
400W ~ 1800W

- Light Source:Luminleds 5050
- Input Volt: 100-277VAC / 347-480VAC
- IP Rating IK Rating : IP66 & IK08
- Beam Angle:10° 30° 60° 90° 137*80° 146*83°
- Color Temp: 3000K 4000K 5000K 5700K 6000K
- 5 years warranty

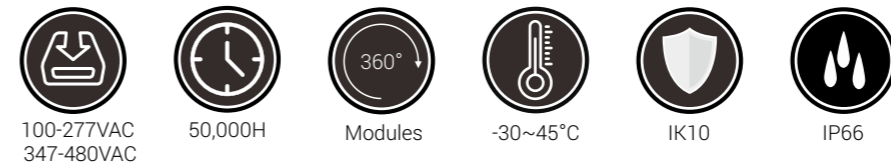

Model	Watt	Efficiency	Lumen	Driver (Meanwell)	Size (LxWxH)	Weight
LSHM-400W-LV(XXX)Ultra	400W	180lm/w±3%	72,000Lm	2* XLG-240-H-A	531x377x129mm	15Kg
LSHM-480W-LV(XXX)Ultra	480W	190LM/W±3%	912,000Lm	2* XLG-240-H-A	637x462x134mm	15Kg
LSHM-600W-LV(XXX)Ultra	600W	180LM/W±3%	108,000Lm	2* ELGC-300-H-A	637x462x134mm	15Kg
LSHM-800W-LV(XXX)Ultra	800W	180LM/W±3%	144,000Lm	4* XLG-240-H-A	763x573x151.5mm	32Kg
LSHM-960W-LV(XXX)Ultra	960W	190LM/W±3%	182,400Lm	4* XLG-240-H-A	869x678x152mm	32Kg
LSHM-1200W-LV(XXX)Ultra	1200W	180LM/W±3%	216,000Lm	4* ELGC-300-H-A	869x678x152mm	48Kg
LSHM-1440W-LV(XXX)Ultra	1440W	190LM/W±3%	273,600Lm	6* XLG-240-H-A	1267x678x152mm	48Kg
LSHM-1800W-LV(XXX)Ultra	1800W	180LM/W±3%	324,000Lm	6* ELGC-300-H-A	1267x678x152mm	48Kg

Beam Angle

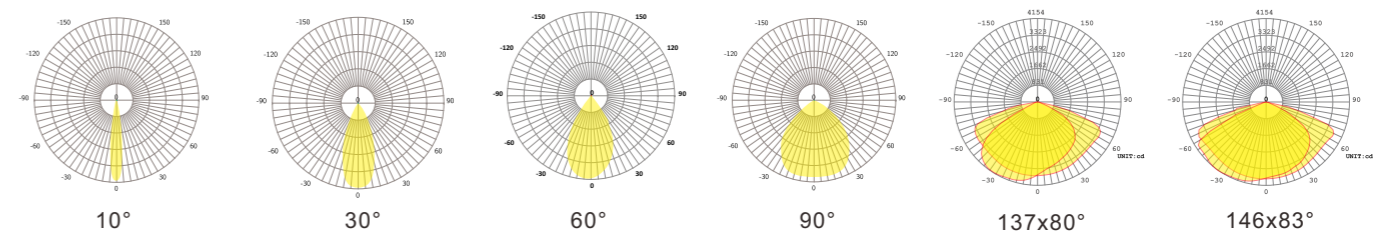

180 Lm/W

SLIM ROUND

SPORTS AND AREA FLOOD LIGHTING



Without anti-glare plate



With anti-glare plate



Slip fitter



Rotatable Arm

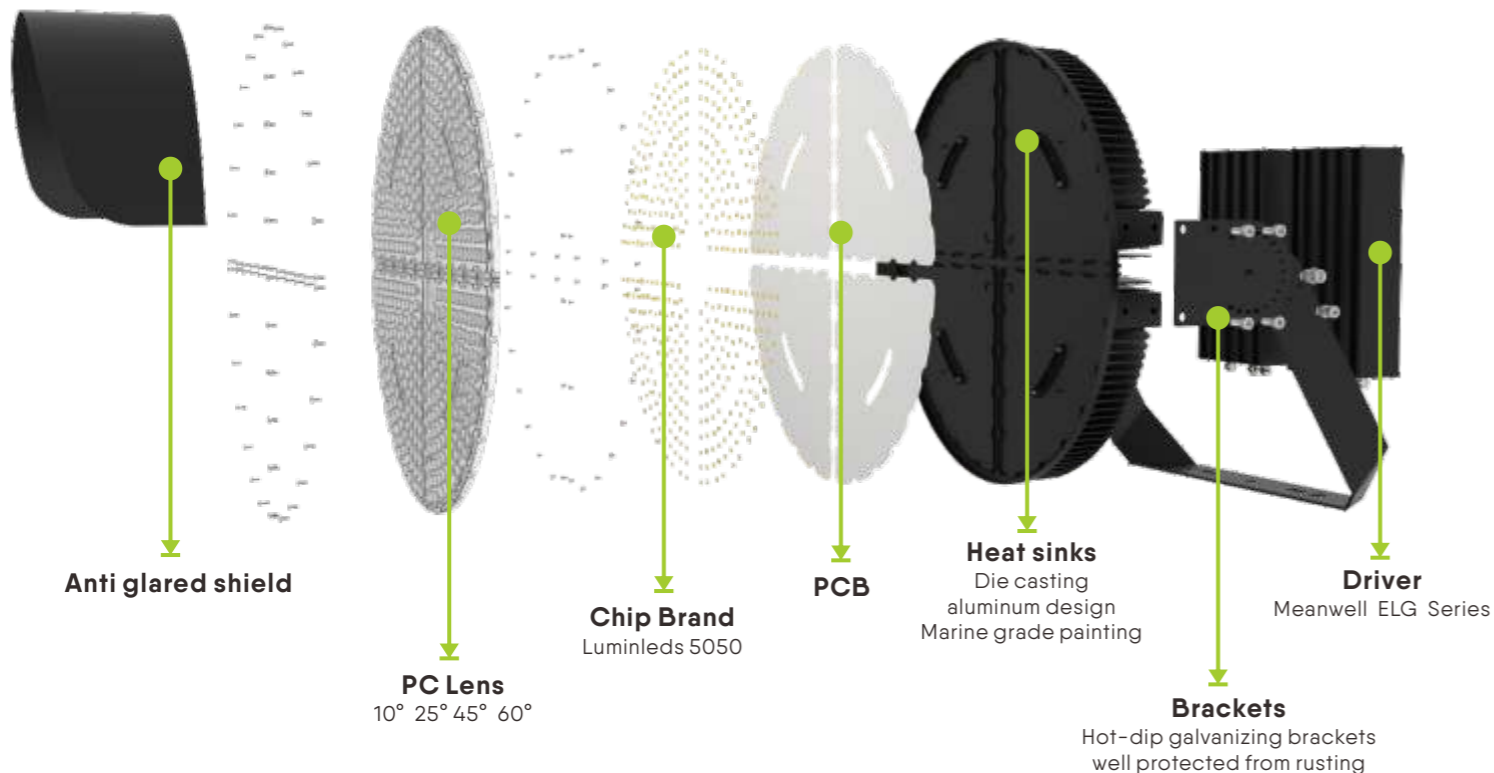

ROUND

LED HIGH MAST LIGHTS

480W 600W 960W 1200W

- Light Source:Luminleds 5050
- Input Volt: 100-277VAC / 347-480VAC
- IP Rating IK Rating : IP66 & IK10
- Beam Angle:10° 25° 45° 60°
- Color Temp: 3000K 4000K 5000K 5700K 6000K
- Anti glared shield :Included
- Dimmable: 1-10V
- SPD:10KV or 20KV
- 5 years warranty



100-277V
347-480V



50,000H



360°
Modules



-40~45°C



IK10



IP66



Wind load
51.0-56.0m/s



FLAME RETARDED



SALT SPRAY TEST



160Lm/W

Model	Watt	Efficiency	Lumen	Driver(Meanwell)	Size (LxWxH)	Weight
LSRHM-480W-LV(XXK)	480W	160lm/w±3%	76,800Lm	2* XLG-240H-A	380x620x645mm	195Kg
LSRHM-600W-LV(XXK)	600W	160lm/w±3%	96,000Lm	2* ELGC-300-H-A	380x620x645mm	195Kg
LSRHM-960W-LV(XXK)	960W	160lm/w±3%	153,600Lm	4* XLG-240H-A	330x460x490mm	34kg
LSRHM-1200W-LV(XXK)	1200W	160lm/w±3%	192,000Lm	4* ELGC-300-H-A	330x460x490mm	34kg

180Lm/W

Model	Watt	Efficiency	Lumen	Driver(Meanwell)	Size (LxWxH)	Weight
LSRHM-480W-LV(XXK)	480W	180lm/w±3%	86,400Lm	2* XLG-240H-A	380x620x645mm	195Kg
LSRHM-600W-LV(XXK)	600W	175lm/w±3%	105,000Lm	2* ELGC-300-H-A	380x620x645mm	195Kg
LSRHM-960W-LV(XXK)	960W	180lm/w±3%	172,800Lm	4* XLG-240H-A	330x460x490mm	34kg
LSRHM-1200W-LV(XXK)	1200W	175lm/w±3%	210,000Lm	4* ELGC-300-H-A	330x460x490mm	34kg

Beam Angle

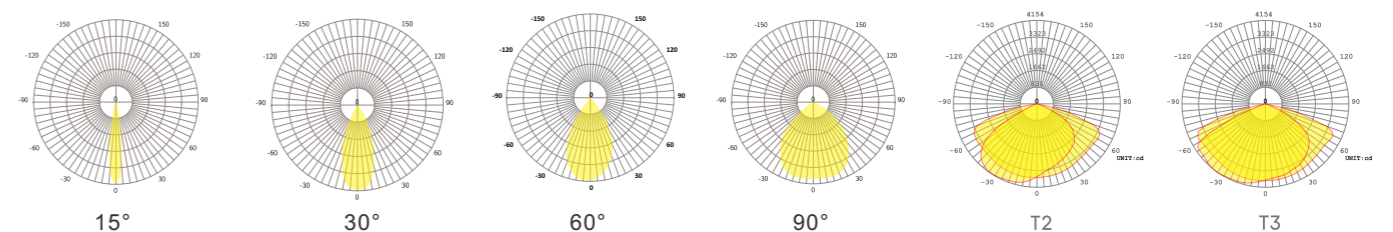



170 Lm/W

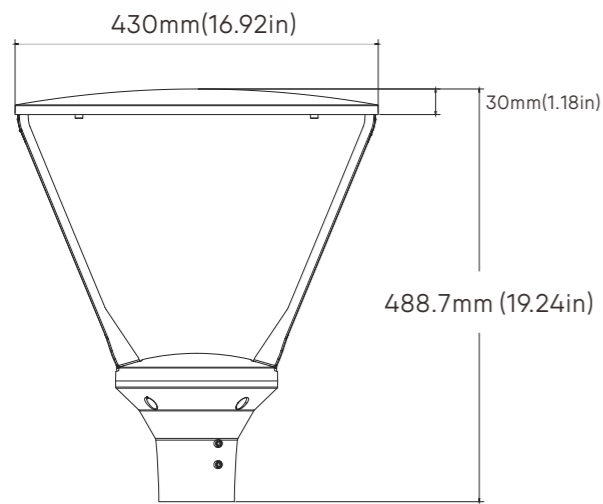

SKYSCRAPER

LED POST TOP LIGHT FIXTURES

The aesthetics of the city is inseparable from lighting, Skyscraper satisfied the trend of urban differentiation with smooth curvature, which effectively prevents the accumulation of dust and leaves, not only creates a neat atmosphere, but also provides excellent heat dissipation. In general, the traditional industrial lighting design is not obvious enough, and through continuous optimization, the overall display is more modern.

TECHNICAL PARAMETERS

Light Source	Lumileds 2835
IK & IP Rating	IK08 / IP66
Input Voltage	100-277VAC
CCT	4000K / 5000K / 5700K
Efficiency	170Lm/W
Beam Angle	3000k~6000K
Lifetime	50,000+ hours
Arm Dia	60-80mm



L	54cm
W	48cm
H	30cm
G.W.	7.5Kg
Box Qty	1PC

SPECIFICATIONS INFORMATION

Model	Watt	Input Voltage	Efficiency	Lumen	Beam Angles	SPD (Optional)	Driver
LSPT-30W(XXK)Plus	30W	100-277VAC	170Lm/w	5100Lm	T2 T3 T4 T5(140x140°)	10KV/20KV	Moso X6L-042V052F
LSPT-40W(XXK)Plus	40W	100-277VAC	165Lm/w	6600Lm	T2 T3 T4 T5(140x140°)	10KV/20KV	Moso X6L-042V052F
LSPT-50W(XXK)Plus	50W	100-277VAC	160Lm/w	8000Lm	T2 T3 T4 T5(140x140°)	10KV/20KV	Moso X6L-060V052F
LSPT-60W(XXK)Plus	60W	100-277VAC	160Lm/w	9600Lm	T2 T3 T4 T5(140x140°)	10KV/20KV	Moso X6L-060V052F
LSPT-80W(XXK)Plus	80W	100-277VAC	155Lm/w	12400Lm	T2 T3 T4 T5(140x140°)	10KV/20KV	Moso MNC-100V-240
LSPT-100W(XXK)Plus	100W	100-277VAC	150Lm/w	15000Lm	T2 T3 T4 T5(140x140°)	10KV/20KV	Moso MNC-100V-240
LSPT-120W(XXK)Plus	120W	100-277VAC	140Lm/w	16800Lm	T2 T3 T4 T5(140x140°)	10KV/20KV	Moso MNC-150V-240
LSPT-150W(XXK)Plus	150W	100-277VAC	140Lm/w	21000Lm	T2 T3 T4 T5(140x140°)	10KV/20KV	Moso MNC-150V-240

SKYSCRAPER

LED POST TOP LIGHT FIXTURES

Led Post Top Pole Lights LED Circular Area Light 30W-80W, Outdoor Lamp Top Pathway Pole Light Fixture for School Street Garden Yard Commercial Area Light, An IP66 Rating for Water-Resistance Our LED post-top/garden light being IP66 & IK08 rated is protected against dust and moisture (or water from a nozzle), making the lighting fixture suitable to damp locations.



Single (1)

Die cast aluminum fitter base secured to pole with two stainless steel, Allen head set screws.

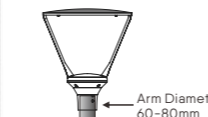
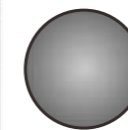

Double (2)

Double luminaire mounting arm secured to pole with four stainless steel, Allen head set screws.

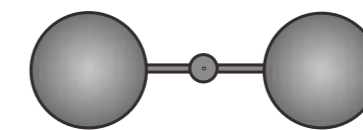

Wall (W)

Double wall mount arm secured to wall with

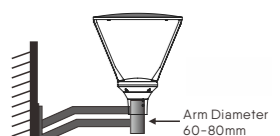
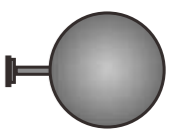

Single post top 10-18 ft. Mounting heights (Spider / Cantilever mount only)

Recommended Optical Angles

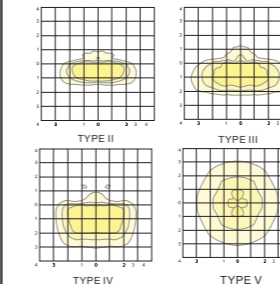

Twin mount arm 18-22 ft. Mounting heights (Spider / Cantilever mount only)

Recommended Optical Angles

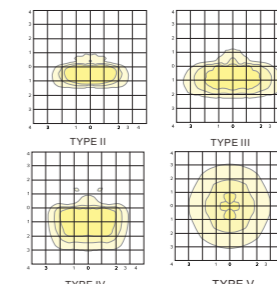

Wall mount arm 8-10 ft. Mounting heights (Spider / Cantilever mount only)

Recommended Optical Angles

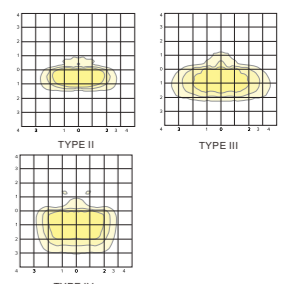



170 Lm/W

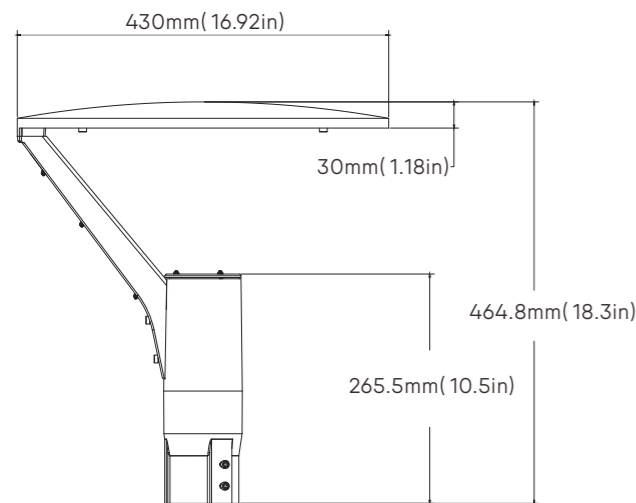

SKYLINE

LED POST TOP LIGHT FIXTURES

The aesthetics of the city is inseparable from lighting, Skyline satisfied the trend of urban differentiation with smooth curvature, which effectively prevents the accumulation of dust and leaves, not only creates a neat atmosphere, but also provides excellent heat dissipation. In general, the traditional industrial lighting design is not obvious enough, and through continuous optimization, the overall display is more modern.

TECHNICAL PARAMETERS

Light Source	Lumileds 2835
IK & IP Rating	IK08 / IP66
Input Voltage	100-277VAC
CCT	4000K / 5000K / 5700K
Efficiency	170Lm/W
Beam Angle	3000k~6000K
Lifetime	50,000+ hours
Arm Dia	60-80mm



L	54cm
W	48cm
H	20
G.W.	8.0Kg
Box Qty	1PC

SPECIFICATIONS INFORMATION

Model	Watt	Input Voltage	Efficiency	Lumen	Beam Angles	SPD (Optional)	Driver
LSPT-30W(XXK)	30W	100-277VAC	170Lm/w	5100Lm	T2 T3 T4 T5(140x140°)	10KV/20KV	Moso X6L-042V052F
LSPT-40W(XXK)	40W	100-277VAC	165Lm/w	6600Lm	T2 T3 T4 T5(140x140°)	10KV/20KV	Moso X6L-042V052F
LSPT-50W(XXK)	50W	100-277VAC	160Lm/w	8000Lm	T2 T3 T4 T5(140x140°)	10KV/20KV	Moso X6L-060V052F
LSPT-60W(XXK)	60W	100-277VAC	160Lm/w	9600Lm	T2 T3 T4 T5(140x140°)	10KV/20KV	Moso X6L-060V052F
LSPT-80W(XXK)	80W	100-277VAC	155Lm/w	12400Lm	T2 T3 T4 T5(140x140°)	10KV/20KV	Moso MNC-100V-240
LSPT-100W(XXK)	100W	100-277VAC	150Lm/w	15000Lm	T2 T3 T4 T5(140x140°)	10KV/20KV	Moso MNC-100V-240
LSPT-120W(XXK)	120W	100-277VAC	140Lm/w	16800Lm	T2 T3 T4 T5(140x140°)	10KV/20KV	Moso MNC-150V-240
LSPT-150W(XXK)	150W	100-277VAC	140Lm/w	21000Lm	T2 T3 T4 T5(140x140°)	10KV/20KV	Moso MNC-150V-240

SKYLINE

LED POST TOP LIGHT FIXTURES

Led Post Top Pole Lights LED Circular Area Light 30W-80W, Outdoor Lamp Top Pathway Pole Light Fixture for School Street Garden Yard Commercial Area Light, An IP66 Rating for Water-Resistance Our LED post-top/garden light being IP66 & IK08 rated is protected against dust and moisture (or water from a nozzle), making the lighting fixture suitable to damp locations.



Single (1)

Die cast aluminum fitter base secured to pole with two stainless steel, Allen head set screws.

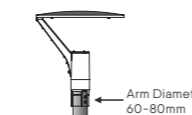
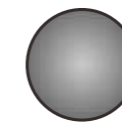

Single post top
10-18 ft. Mounting heights
(Spider / Cantilever mount only)

Recommended Optical Angles

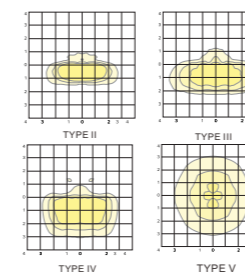

Double (2)

Double luminaire mounting arm secured to pole with four stainless steel, Allen head set screws.

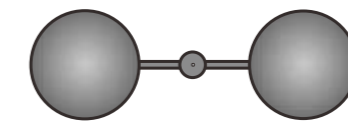

Twin mount arm
18-22 ft. Mounting heights
(Spider / Cantilever mount only)

Recommended Optical Angles

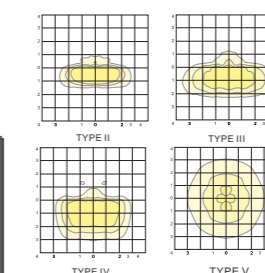

Wall (W)

Double wall mount arm secured to wall with four stainless steel, Allen head set screws.

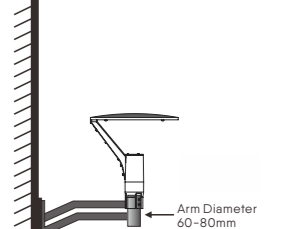
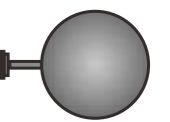

Wall mount arm
8-10 ft. Mounting heights
(Spider / Cantilever mount only)

Recommended Optical Angles

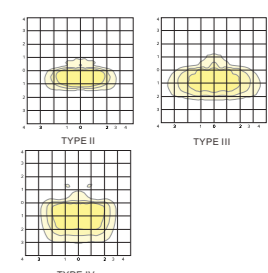

MARS SERIES

LED STREET LIGHT 40W - 200W

165 Lm/W

MARS

LED STREET LIGHTS

- Light Source: Lumileds 3030/Lumileds 5050
- Input Volt: 100-277Vac
- IP Rating: IP66 IK09
- Beam Angle: Type II, Type III, Type IV
- Color Temp: 3000-6000K
- Arm Dia: 60mm
- Complete illumination across the entire roadway
- No external reflectors required
- 5 years warranty



LED STREET LIGHT

MARS LED STREET LIGHTS



Constitute

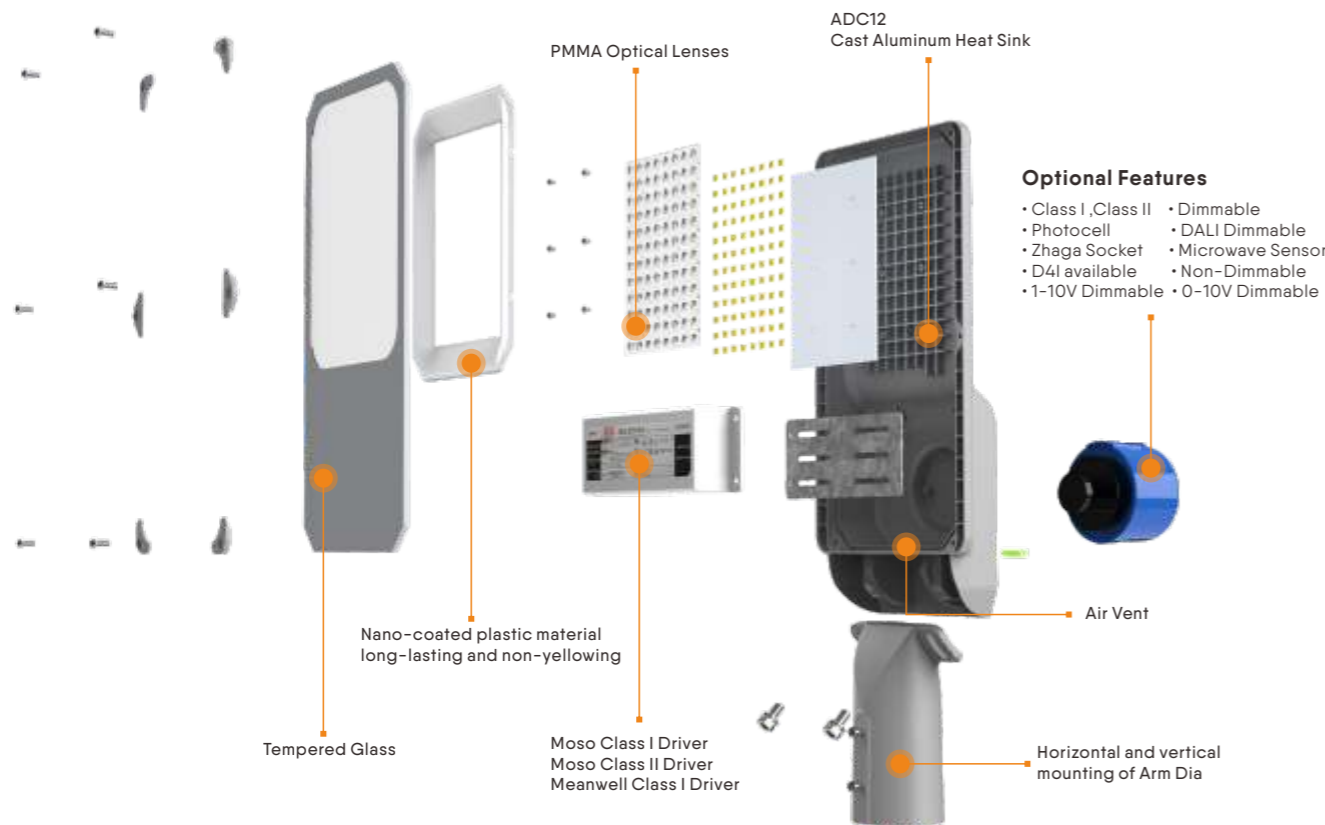

	TINY MODEL	TINY MODEL	SMALL MODEL	SMALL MODEL
Model	LSMSL-T40W-LV(XXX)	LSMSL-T60W-LV(XXX)	LSMSL-S80W-LV(XXX)	LSMSL-S100W-LV(XXX)
Watt	40W	60W	80W	100W
Efficiency #1	130lm/w±3%	130lm/w±3%	130lm/w±3%	130lm/w±3%
Efficiency #2 #3	165Lm/w±3% 170Lm/w±3%	150Lm/w±3% 165Lm/w±3%	150Lm/w±3% 165Lm/w±3%	150Lm/w±3% 165Lm/w±3%
Lumen	5,200Lm / 6,600Lm / 6,800Lm	7,800Lm / 9,000Lm / 9,900Lm	10,400Lm / 12,000Lm / 13,200Lm	13,000Lm / 15,000Lm / 16,500Lm
Meanwell Class I Driver	XLG-50-H-A	XLG-75-H-A	XLG-100-H-A	XLG-100-H-A
Surge protection	6KV	6KV	10KV	10KV

	MEDIUM MODEL	MEDIUM MODEL	LARGE MODEL	LARGE MODEL
Model	LSMSL-M120W-LV(XXX)	LSMSL-M150W-LV(XXX)	LSMSL-L180W-LV(XXX)	LSMSL-L200W-LV(XXX)
Watt	120W	150W	180W	200W
Efficiency #1	130lm/w±3%	130lm/w±3%	130lm/w±3%	130lm/w±3%
Efficiency #2 #3	150Lm/w±3% 165Lm/w±3%	150Lm/w±3% 165Lm/w±3%	150Lm/w±3% 165Lm/w±3%	150Lm/w±3% 165Lm/w±3%
Lumen	15,600Lm / 18,000Lm / 19,800Lm	19,500Lm / 22,500Lm / 24,750Lm	23,400Lm / 27,000Lm / 29,700Lm	13,000Lm / 30,000Lm / 33,000Lm
Meanwell Class I Driver	XLG-150-H-A	XLG-150-H-A	XLG-200-H-A	XLG-200-H-A
Surge protection	10KV	10KV	10KV	10KV

Moso Class I Driver

40W: X6-042V052L 60W: X6-060V052L 80W: X6E-075M075
 100W: X6E-100M100 120W/150W: X6E-150M150
 180W/200W: X6E-200M200

Moso Class II Driver

40W: LCP-040M048 60W/80W: XCP-75V062
 100W: XCP-105V062 120W/150W: XCP-150V062
 180W/200W: XCP-200V062

Beam Angle

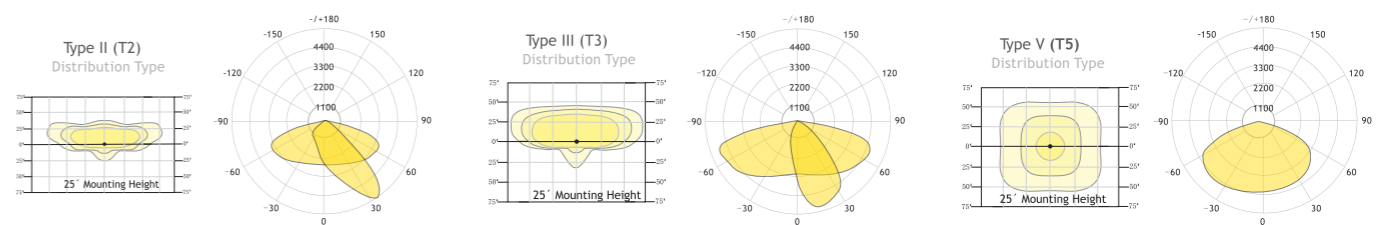

180 Lm/W

STREAMLINED PLUTO SERIES

LED STREET LIGHT 40W-300W



STREAMLINED PLUTO

LED STREET LIGHTS

- Light Source: Lumileds 3030
- Input Volt: 100-277VAC
- IP Rating: IP66 IK08
- Beam Angle: Type II, Type III, Type IV
- Color Temp: 3000K 4000K 5000K 5700K
- Arm Dia: 60mm 48mm 42mm
- Lifespan: 100,000hrs
- Photocell: On at Dusk and Off at Dawn. 0-10V NEMA dimming
- 5 years warranty



STREAMLINED DESIGN PLUTO LED STREET LIGHTS

Light-output compensation(CLO),time dimming control



▼ MOUNTING OPTIONS / PHOTOCELL

The Pluto led street fixture can be mounted horizontally or vertically with our universal slip fit system. Simply detach and rotate the slip fitter 180°. to achieve the vertical orientation. Both orientation options include the ability to rotate 15° or more.



Horizontal MOUNTING
Post-top position
(rotates ±15°)

Vertical MOUNTING
Side-entry position
(rotates ±15°)

Light-output compensation(CLO)
Time dimming control



Optional Features

- Class I, Class II
- Photocell
- Zhaga Socket
- D4I available
- 1-10V Dimmable
- Dimmable
- DALI Dimmable
- Microwave Sensor
- Non-Dimmable
- 0-10V Dimmable

Part Number	LSPSL-40W-LV(XXK)	LSPSL-60W-LV(XXK)	LSPSL-80W-LV(XXK)	LSPSL-100W-LV(XXK)	LSPSL-120W-LV(XXK)
Watt	40W	60W	80W	100W	120W
Efficiency	145LM/W±3%	135LM/W±3%	130LM/W±3%	130LM/W±3%	130LM/W±3%
Chip Brand	Lumileds 3030	Lumileds 3030	Lumileds 3030	Lumileds 3030	Lumileds 3030
Lumen	5,800Lm	8,100Lm	10,400Lm	13,000Lm	15,600Lm
Meanwell Class I driver	XLG-50-H-A	XLG-75-H-A	XLG-75-H-A	XLG-100-H-A	XLG-150-H-A
Moso Class II driver	LCP-040M048	XCP-75V062	XCP-75V062	XCP-105V062	XCP-150V062
Moso Class I driver	X6-042V052L	X6-060V052L	X6-075M075	X6-100M100	X6-150M150
Terminal Block	included	included	included	included	included
Surge protection	10KV	10KV	10KV	10KV	10KV

Part Number	LSPSL-150W-LV(XXK)	LSPSL-180W-LV(XXK)	LSPSL-200W-LV(XXK)	LSPSL-240W-LV(XXK)	LSPSL-300W-LV(XXK)
Watt	150W	180W	200W	240W	300W
Efficiency	130LM/W±3%	130LM/W±3%	130LM/W±3%	130LM/W±3%	130LM/W±3%
Chip Brand	Lumileds 3030	Lumileds 3030	Lumileds 3030	Lumileds 3030	Lumileds 3030
Lumen	22,500Lm	23,400Lm	26,000Lm	31,200Lm	39,000Lm
Meanwell Class I driver	XLG-150-H-A	XLG-200-H-A	XLG-200-H-A	XLG-240-H-A	XLG-300-H-A
Moso Class II driver	XCP-150V062	XCP-200V062	XCP-200V062	XCP-240M062	XCP-320M062
Moso Class I driver	X6E-150M150	X6E-200M200	X6E-200M200	X6-240M062	X6-320V062
Terminal Block	included	included	included	included	included
Surge protection	10KV	10KV	10KV	10KV	10KV

Beam Angle

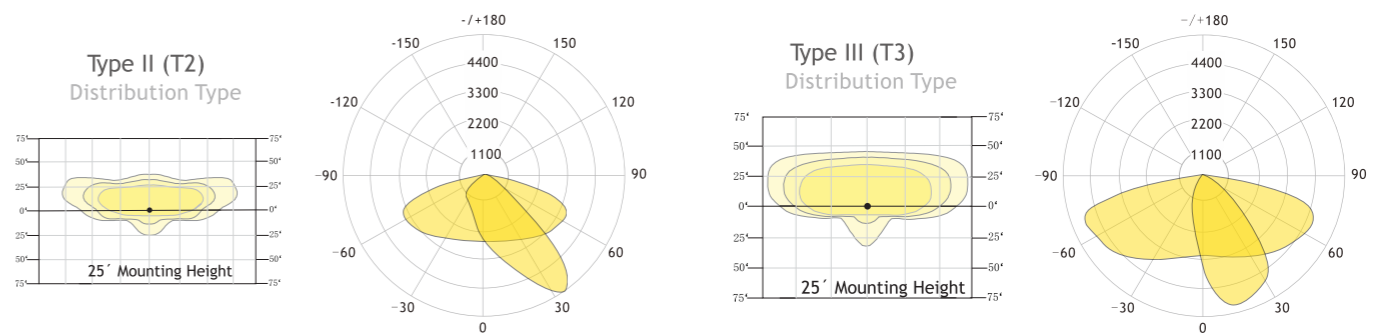

STREAMLINED PLUTO

180Lm/W



LED STREET LIGHTS

- Light Source: Lumileds 3030
- Input Volt: 100-277VAC
- IP Rating: IP66 IK08
- Beam Angle: Type II, Type III, Type IV
- Color Temp: 3000K 4000K 5000K 5700K
- Arm Dia: 60mm 48mm 42mm
- Lifespan: 100,000hrs
- Photocell: On at Dusk and Off at Dawn. 0-10V NEMA dimming
- 5 years warranty



STREAMLINED PLUTO LED STREET LIGHTS 150LM/W

Part Number	LSPSL-40W-LV(XXK)	LSPSL-60W-LV(XXK)	LSPSL-80W-LV(XXK)	LSPSL-100W-LV(XXK)	LSPSL-120W-LV(XXK)
Watt	40W	60W	80W	100W	120W
Efficiency	150LM/W±3%	150LM/W±3%	150LM/W±3%	150LM/W±3%	150LM/W±3%
Chip Brand	Lumileds 5050	Lumileds 5050	Lumileds 5050	Lumileds 5050	Lumileds 5050
Lumen	6,000Lm	9,000Lm	12,000Lm	15,000Lm	18,000Lm
Meanwell Class I driver	XLG-50-H-A	XLG-75-H-A	XLG-75-H-A	XLG-100-H-A	XLG-150-H-A
Moso Class II driver	LCP-040M048	XCP-75V062	XCP-75V062	XCP-105V062	XCP-150V062
Moso Class I driver	X6-042V052L	X6-060V052L	X6E-075M075	X6E-100M100	X6E-150M150
Terminal Block	included	included	included	included	included
Surge protection	10KV	10KV	10KV	10KV	10KV

Part Number	LSPSL-150W-LV(XXK)	LSPSL-180W-LV(XXK)	LSPSL-200W-LV(XXK)	LSPSL-240W-LV(XXK)	LSPSL-300W-LV(XXK)
Watt	150W	180W	200W	240W	300W
Efficiency	150LM/W±3%	150LM/W±3%	150LM/W±3%	150LM/W±3%	150LM/W±3%
Chip Brand	Lumileds 5050	Lumileds 5050	Lumileds 5050	Lumileds 5050	Lumileds 5050
Lumen	22,500Lm	27,000Lm	30,000Lm	36,000Lm	48,000Lm
Meanwell Class I driver	XLG-150-H-A	XLG-200-H-A	XLG-200-H-A	XLG-240-H-A	XLG-300-H-A
Moso Class II driver	XCP-150V062	XCP-200V062	XCP-200V062	XCP-240M062	XCP-320M062
Moso Class I driver	X6E-150M150	X6E-200M200	X6E-200M200	X6-240M062	X6-320V062
Terminal Block	included	included	included	included	included
Surge protection	10KV	10KV	10KV	10KV	10KV

Beam Angle

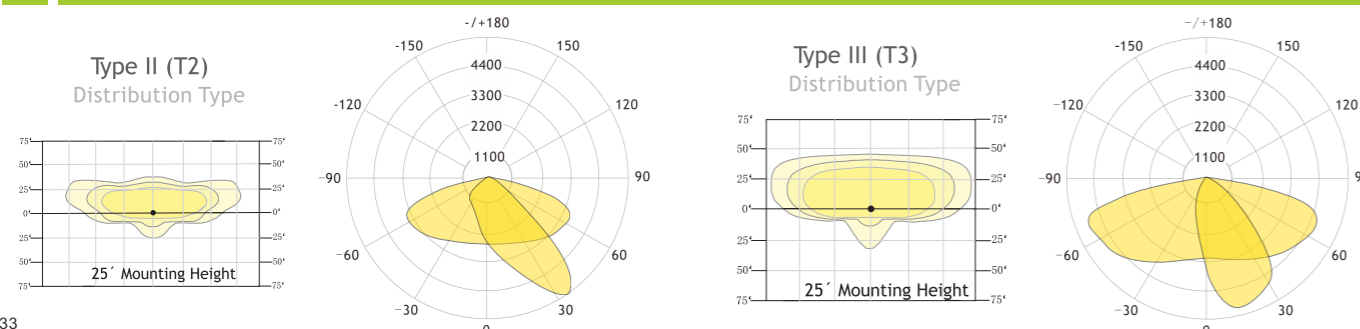

STREAMLINED PLUTO LED STREET LIGHTS 165LM/W

Part Number	LSPSL-40W-LV(XXK)	LSPSL-60W-LV(XXK)	LSPSL-80W-LV(XXK)	LSPSL-100W-LV(XXK)	LSPSL-120W-LV(XXK)
Watt	40W	60W	80W	100W	120W
Efficiency	165LM/W±3%	165LM/W±3%	165LM/W±3%	165LM/W±3%	165LM/W±3%
Chip Brand	Lumileds 5050	Lumileds 5050	Lumileds 5050	Lumileds 5050	Lumileds 5050
Lumen	6,600Lm	9,900Lm	13,200Lm	16,500Lm	19,800Lm
Meanwell Class I driver	XLG-50-H-A	XLG-75-H-A	XLG-100-H-A	XLG-100-H-A	XLG-150-H-A
Moso Class II driver	LCP-040M048	XCP-75V062	XCP-75V062	XCP-105V062	XCP-150V062
Moso Class I driver	X6-042V052L	X6-060V052L	X6E-075M075	X6E-100M100	X6E-150M150
Terminal Block	included	included	included	included	included
Surge protection	10KV	10KV	10KV	10KV	10KV

Part Number	LSPSL-150W-LV(XXK)	LSPSL-180W-LV(XXK)	LSPSL-200W-LV(XXK)	LSPSL-240W-LV(XXK)	LSPSL-300W-LV(XXK)
Watt	150W	180W	200W	240W	300W
Efficiency	165LM/W±3%	165LM/W±3%	165LM/W±3%	165LM/W±3%	165LM/W±3%
Chip Brand	Lumileds 5050	Lumileds 5050	Lumileds 5050	Lumileds 5050	Lumileds 5050
Lumen	24,750Lm	29,700Lm	33,000Lm	39,600Lm	49,500Lm
Meanwell Class I driver	XLG-150-H-A	XLG-200-H-A	XLG-200-H-A	XLG-240-H-A	XLG-300-H-A
Moso Class II driver	XCP-150V062	XCP-200V062	XCP-200V062	XCP-240M062	XCP-320M062
Moso Class I driver	X6E-150M150	X6E-200M200	X6E-200M200	X6-240M062	X6-320V062
Terminal Block	included	included	included	included	included
Surge protection	10KV	10KV	10KV	10KV	10KV

STREAMLINED PLUTO LED STREET LIGHTS 180LM/W

Part Number	LSPSL-40W-LV(XXK)	LSPSL-60W-LV(XXK)	LSPSL-80W-LV(XXK)	LSPSL-100W-LV(XXK)	LSPSL-120W-LV(XXK)
Watt	40W	60W	80W	100W	120W
Efficiency	180LM/W±3%	180LM/W±3%	180LM/W±3%	180LM/W±3%	180LM/W±3%
Chip Brand	Lumileds 5050	Lumileds 5050	Lumileds 5050	Lumileds 5050	Lumileds 5050
Lumen	7,200Lm	10,800Lm	14,400Lm	18,000Lm	21,600Lm
Meanwell Class I driver	XLG-50-H-A	XLG-75-H-A	XLG-100-H-A	XLG-100-H-A	XLG-150-H-A
Moso Class II driver	LCP-040M048	XCP-75V062	XCP-105V062	XCP-105V062	XCP-150V062
Moso Class I driver	X6-042V052L	X6-060V052L	X6E-075M075	X6E-100M100	X6E-150M150
Terminal Block	included	included	included	included	included
Surge protection	10KV	10KV	10KV	10KV	10KV

Part Number	LSPSL-150W-LV(XXK)	LSPSL-180W-LV(XXK)	LSPSL-200W-LV(XXK)		
Watt	150W	180W	200W		
Efficiency	180LM/W±3%	180LM/W±3%	180LM/W±3%		
Chip Brand	Lumileds 3030	Lumileds 3030	Lumileds 3030		
Lumen	22,500Lm	32,400Lm	36,000Lm		
Meanwell Class I driver	XLG-150-H-A	XLG-240-H-A	XLG-240-H-A		
Moso Class II driver	XCP-150V062	XCP-200V062	XCP-200V062		
Moso Class I driver	X6E-150M150	X6E-200M200	X6E-200M200		
Terminal Block	included	included	included		
Surge protection	10KV	10KV	10KV		

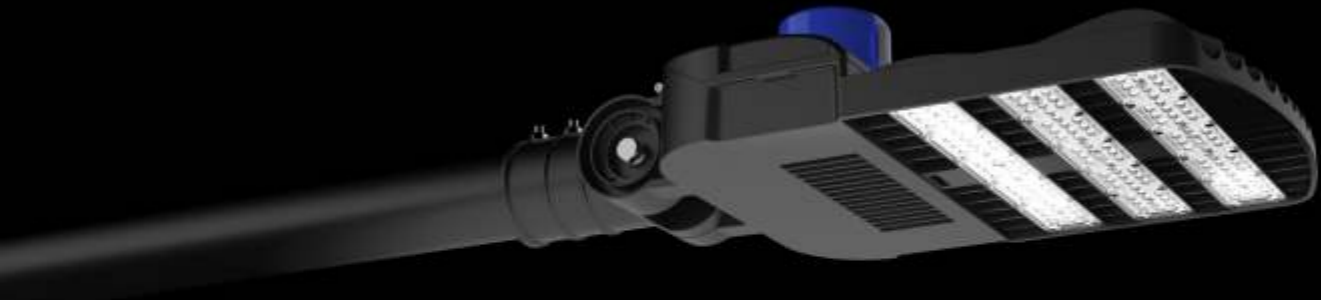

VENUS SERIES

LED STREET LIGHT 50W-240W

LED STREET LIGHT

LED Outdoor Street Light

5 Years Warranty
10000 Hour Long Service Life

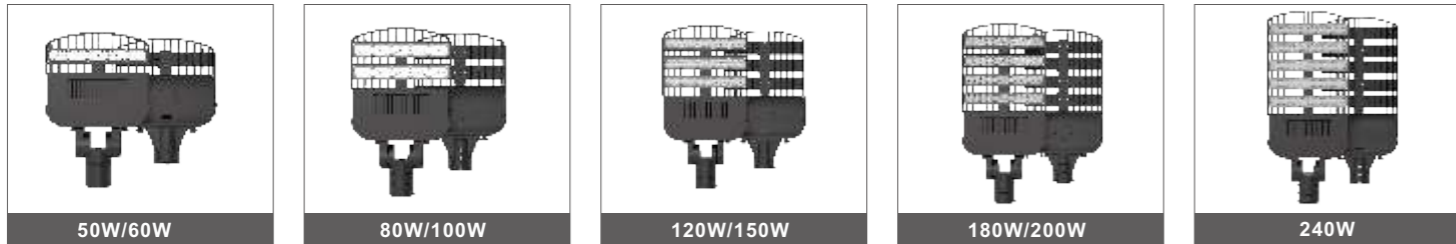

MOUNTING OPTIONS

The Venus led street light fixture includes simple installation with convenient adjustability. The Venus led street light fixture can be mounted horizontally or vertically.

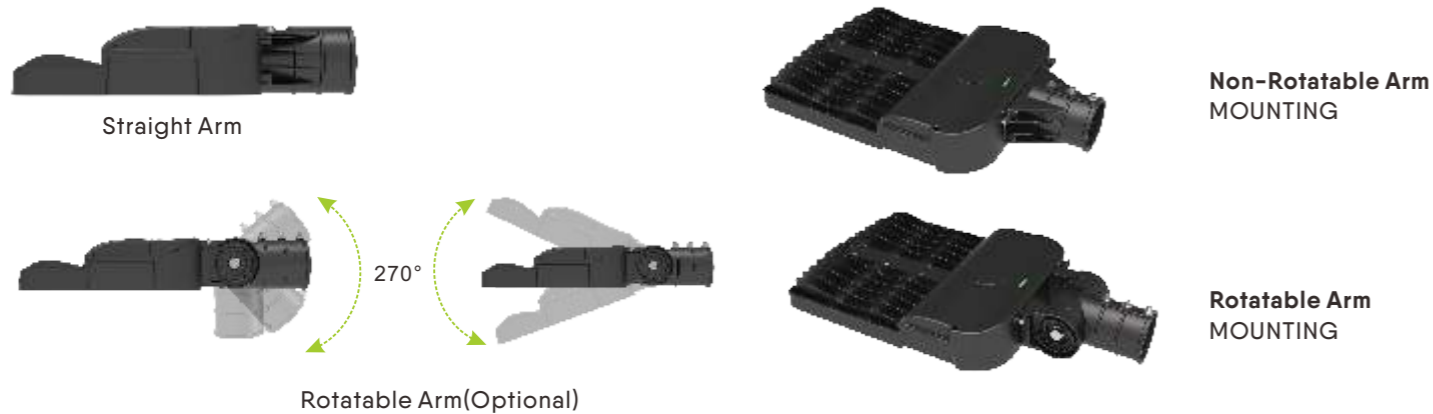

VENUS

LED STREET LIGHTS

- Light Source: Lumileds 3030
- Input Volt: 100-277VAC
- IP Rating IK Rating: IP67 IK08
- Beam Angle: Type3 80*155°
- Color Temp: 3000K 4000K 5000K 5700K
- Arm Dia: 60mm
- 5 years warranty



White housing
Black housing

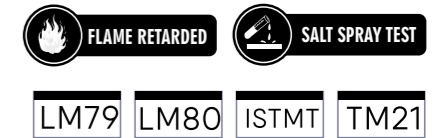

Part Number	LSVSL-50W-LV(XXK)	LSVSL-60W-LV(XXK)	LSVSL-80W-LV(XXK)	LSVSL-100W-LV(XXK)
Watt	50W	60W	80W	100W
Efficiency	150LM/W±3%	150LM/W±3%	150LM/W±3%	150LM/W±3%
Dimensions (mm)	406x320x86mm	406x320x86mm	417x320x86mm	417x320x86mm
Lumen	7,500Lm	9,000Lm	12,000Lm	15,000Lm
Driver	XLG-50-H-A	XLG-75-H-A	XLG-100-H-A	XLG-100-H-A

Part Number	LSPSL-120W-LV(XXK)	LSVSL-150W-LV(XXK)	LSPSL-180W-LV(XXK)	LSPSL-200W-LV(XXK)	LSPSL-240W-LV(XXK)
Watt	100W	120W	180W	200W	240W
Efficiency	150LM/W±3%	150LM/W±3%	150LM/W±3%	150LM/W±3%	150LM/W±3%
Dimensions (in)	548x320x86mm	548x320x86mm	619x320x86mm	619x320x86mm	690x320x86mm
Lumen	15,000Lm	18,000Lm	27,000Lm	30,000Lm	36,000Lm
Driver	XLG-150-H-A	XLG-150-H-A	XLG-240-H-A	XLG-240-H-A	XLG-240-H-A



Beam Angle

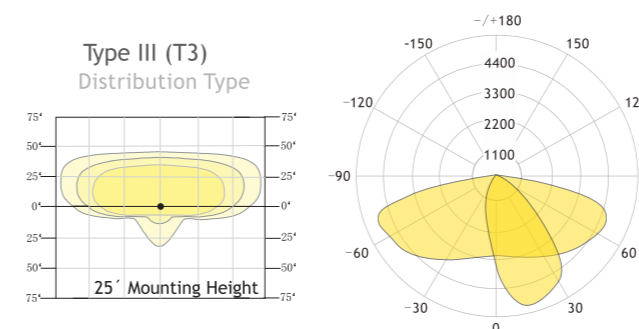



SATURN SERIES

LED STREET LIGHT 20W-200W

LED STREET LIGHT

LED Outdoor Street Light

5 Years Warranty
100000 Hour Long Service Life



Installation Accessories



2 Lights Adaptor Coner bracket



L bracket for 60mm pole post top



Wall Mount Bracket adaptor for dia 60mm spigot



Corner Adaptor



Rotatable adaptor (dia 60mm to dia60mm) (dia 60mm to dia76mm)



Photocell sensor



NEMA 5pins



NEMA 7pins



NEMA short cap



10KV SPD

SATURN

LED STREET LIGHTS

- Light Source: Lumileds 3030
- Input Volt: 100-240VAC
- IP Rating IK Rating : IP67 IK08
- Beam Angle: Type2 Type3 Type4
- Color Temp: 3000K 4000K 5000K 5700K 6000K
- Arm Dia: 60mm / 42mm(20-60W)
- 5 years warranty



- White housing
- Gray housing
- Black housing



100-277V



50,000H



Dimmable



-30~45°C



IK08



IP67



FLAME RETARDED



SALT SPRAY TEST



LM79



LM80



ISTMT



TM21

Part Number	LSSSL-20W(XXX)	LSSSL-30W(XXX)	LSSSL-40W(XXX)	LSSSL-50W(XXX)	LSSSL-60W(XXX)	LSSSL-80W(XXX)
Watt	20W	30W	40W	50W	60W	80W
Efficiency	140LM/W±3%	135LM/W±3%	135LM/W±3%	130LM/W±3%	130LM/W±3%	135LM/W±3%
Dimensions (mm)	491*190*82mm	491*190*82mm	491*190*82mm	491*190*82mm	491*190*82mm	547*240*82mm
Lumen	2,800Lm	4,050Lm	5,400Lm	6,500Lm	7,800Lm	10,800Lm
Driver	SS-30VA-56	SS-30VA-56	SS-50VA-56	SS-50VA-56	SS-60H-54	SS-100GA-56

Part Number	LSSSL-100W(XXX)	LSSSL-120W(XXX)	LSSSL-150W(XXX)	LSSSL-180W(XXX)	LSSSL-200W(XXX)
Watt	100W	120W	150W	180W	200W
Efficiency	135LM/W±3%	135LM/W±3%	135LM/W±3%	130LM/W±3%	125LM/W±3%
Dimensions (in)	547*240*82mm	549*280*92mm	549*280*92mm	549*280*92mm	549*280*92mm
Lumen	13,500Lm	16,200Lm	20,250Lm	23,400Lm	26,000Lm
Driver	SS-150GA-56	SS-150GA-56	SS-150GA-56	SS-200GA-56	SS-200GA-56



Beam Angle

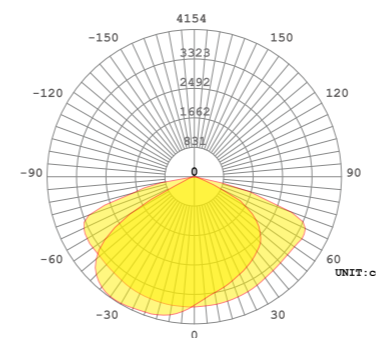

T2M

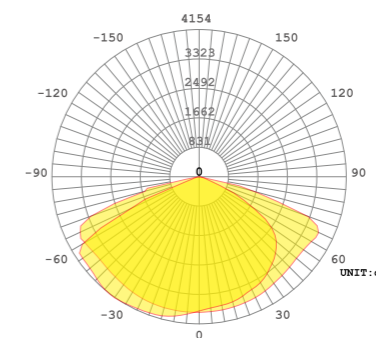

T3M

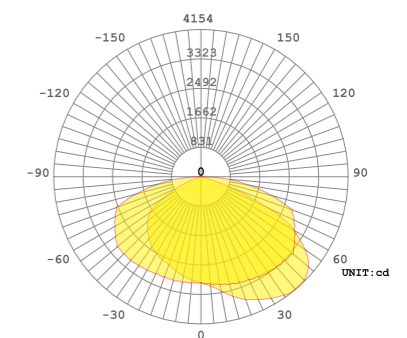

T4M

200 Lm/W

SLIM SERIES

LED UFO High Bay Light



LIGHTER IN WEIGHT SMALLER IN SIZE
SAVE SHIPPING COST HIGH LUMENS EFFICACY



SLIM SERIES

UFO LED HIGH BAY LIGHT

- Light Source: Osram 2835
- Input Volt: 100-277VAC
- IP Rating: IP65
- Lifespan: > 50,000 hours
- Color Temp: 4000K 5000K 5700K
- 5 years warranty

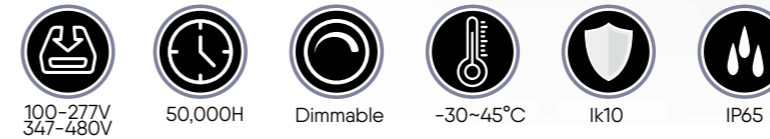

Part Number	LSUFO-100WXY-LVS(XXK)	LSUFO-150WXY-LVS(XXK)	LSUFO-200WXY-LVS(XXK)
Watt	100W	150W	200W
Efficiency	160lm/w±3% 200lm/w±3%	160lm/w±3% 200lm/w±3%	160lm/w±3% 200lm/w±3%
Dimensions (mm)	Dia258xH147mm	Dia299xH147mm	Dia347xH150mm
Lumen	16,000Lm 20,000Lm	22,500Lm 30,000Lm	32,000Lm 40,000Lm
Driver	G6-120V260	G6-160V260	G6-200V260
Net weight	2.35Kg	2.65Kg	4.5Kg

Part Number	LSUFO-300WXY-LVS(XXK)	LSUFO-400WXY-LVS(XXK)
Watt	300W	400W
Efficiency	150lm/w±3% / 170lm/w±3%	150lm/w±3% / 170lm/w±3%
Dimensions (mm)	Dia400xH130mm	Dia400xH202mm
Lumen	45,000Lm 51,000Lm	60,000Lm / 68,000Lm
Driver	SS-300CA-56BH	SS-480CA-228BH
Net weight	2.35Kg	2.65Kg

Beam Angle

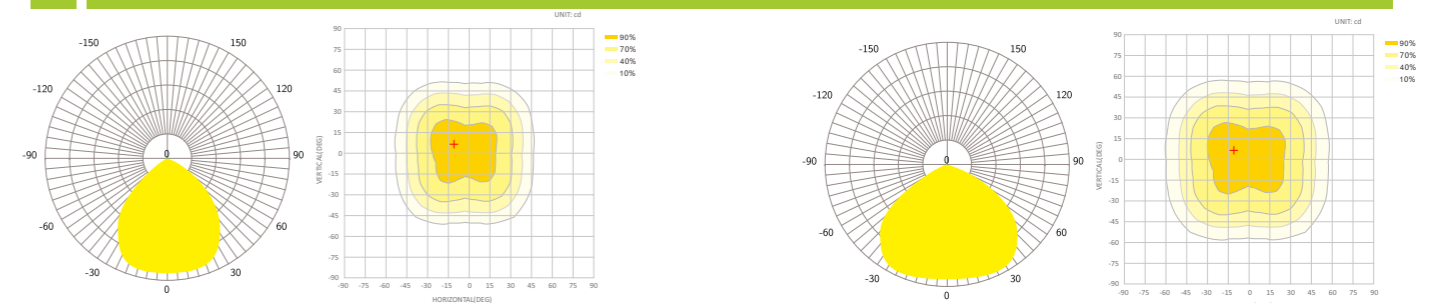

90°

120°

200 Lm/W



MOTION SENSOR SERIES
GRAPHENE UFO LED HIGH BAY LIGHT

High Luminaire Efficiency

High luminaire efficiency up to 200lm/w, CRI > 80
Mounting Height: 8-15meter

5 Years Warranty
10000^{Hour} Long Service Life



Plug and Play

Unscrew the panel clockwise

Screw on the sensor counterclockwise

Lamp comes with short cap, you are able to twist and lock the sensor easily. Motion sensor need to be ordered separately, easy for stock.

- On/off control
- Stand-by dimming level
- Detection area
- Remote control setting
- Hold time
- Daylight sensor
- Stand-by period
- 10-15M Highbay altitude
- Dimmable

Motion Sensor

Built-in induction sensor UFO led high bay light

- Light Source: Osram 2835
- Input Volt: 100-277VAC
- IP Rating: IP65
- Lifespan: > 50,000 hours
- Color Temp: 4000K 5000K 5700K
- 5 years warranty



- 100-277V 347-480V
- 50,000H
- Dimmable
- 30~45°C
- IK10
- IP65

Part Number	LSUFO-100WXY-GS(XXX)	LSUFO-150WXY-GS(XXX)	LSUFO-200WXY-GS(XXX)
Watt	100W	150W	200W
Efficiency	160Lm/W 200Lm/W	160Lm/W 200Lm/W	160Lm/W 200Lm/W
Dimensions (mm)	Φ 290x174mm	Φ 340x181mm	Φ 380x183mm
Lumen	16,000Lm 20,000Lm	24,000Lm 30,000Lm	32,000Lm 40,000Lm
Driver (MOSO)	G6-120M260A12H	G6-160M260A12H	G6-200M260A12H
Net weight	2.27Kg	2.64Kg	2.64Kg

Lux on/off

Preconditions to use the Lux-off function:

1. Standby period is +∞;
2. Standby dimming level is on 10%, 20% or 30%;
3. Daylight threshold is on 30Lux, 50Lux, 80Lux or 120Lux.

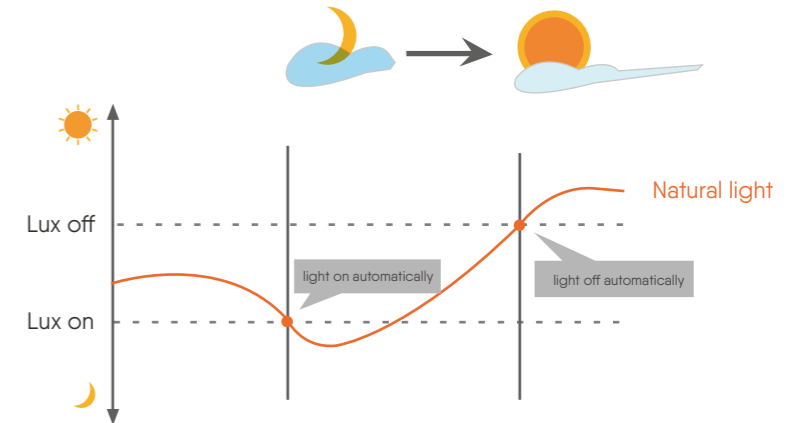

Application—Lux on/off

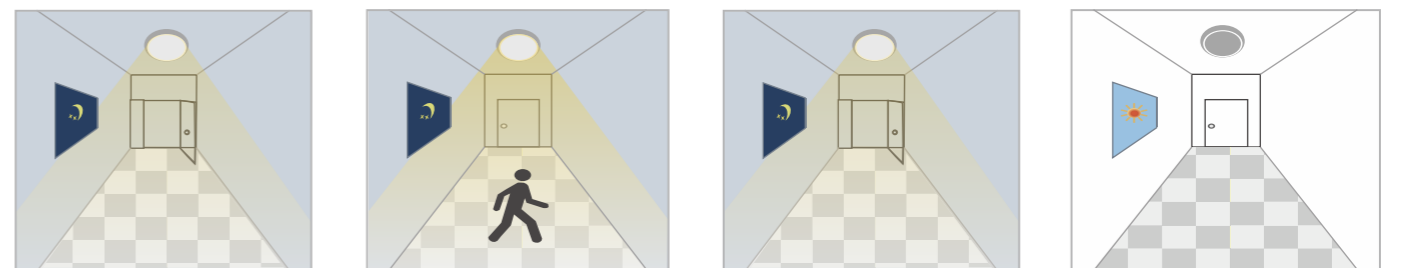

Light automatically on when ambient brightness is lower than preset lux level.

With insufficient ambient brightness, light dims to 100% when motion detected.

Light dims to standby level if no motion detected after holdtime.

Light off when ambient lux level is higher than preset lux amount.



180 Lm/W

LINEAR SERIES
LED HIGH BAY LIGHT



LINEAR
LED HIGH BAY LIGHT

- Light Source: Lumiled 2835
- Input Volt: 100-277VAC
- IP & IK Rating : IP65 & IK10
- Beam Angle: 40°/60°/90°/120°/40*100°/P50
- Color Temp: 3000K-6000K
- Each lamp comes with 2sets of 1m irerope+2hooks
- Surge protection: 6KV
- Suspension mount or Ceiling mount
- 5 years warranty



LINEAR LED HIGH BAY LIGHT FIXTURES

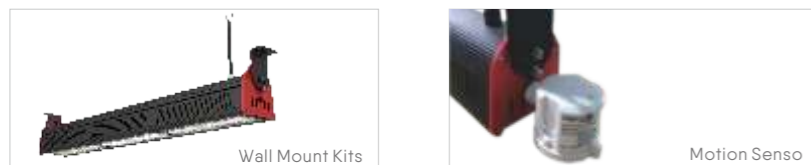

SPECIFICATIONS INFORMATION

Model	Watt	Input Voltage	Efficiency #1	Lumen #1	Efficiency #2	Lumen #2	Meanwell Driver	MOSO Driver
LSLHBL-50W	50W	100-277VAC	160LM/W±3%	8,000Lm	180LM/W±3%	9,000Lm		MNC-100B240
LSLHBL-100W	100W	100-277VAC	160LM/W±3%	16,000Lm	180LM/W±3%	18,000Lm	XLG-100-H-A	MNC-100B240
LSLHBL-150W	150W	100-277VAC	160LM/W±3%	24,000Lm	180LM/W±3%	27,000Lm	XLG-150-H-A	MNC-150B240
LSLHBL-200W	200W	100-277VAC	160LM/W±3%	32,000Lm	180LM/W±3%	36,000Lm	XLG-240-48A	MNC-100B240
LSLHBL-240W	240W	100-277VAC	160LM/W±3%	38,400Lm	180LM/W±3%	43,200Lm	XLG-240-48A	MNC-240B240
LSLHBL-300W	300W	100-277VAC	160LM/W±3%	48,000Lm	180LM/W±3%	54,000Lm	2*XLG-150-H-A	2pcs MNC-150B240
LSLHBL-400W	400W	100-277VAC	160LM/W±3%	64,000Lm	180LM/W±3%	72,000Lm	2*XLG-240-48A	2pcs MNC-200B240
LSLHBL-500W	500W	100-277VAC	160LM/W±3%	80,000Lm	180LM/W±3%	90,000Lm	2*XLG-240-48A	2pcs MNC-240B240

Beam Angle

Symmetrical Angle

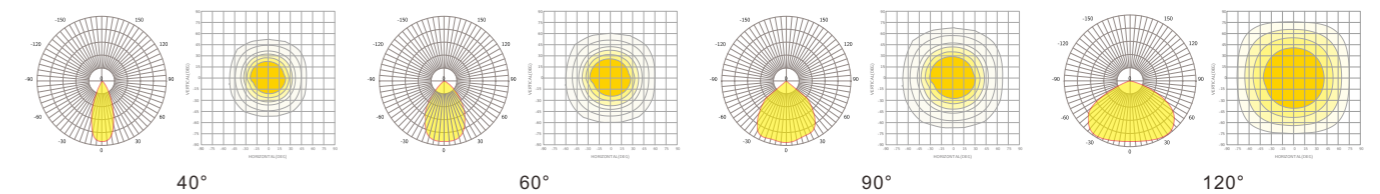

Polarization Angle

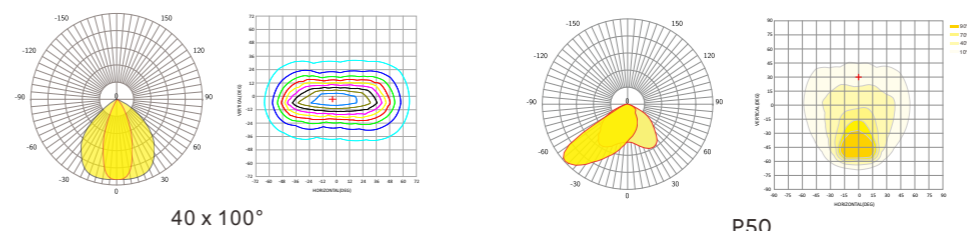



180 Lm/W

Anti-Glared
Tennis court lighting

NEMO SERIES
LED FLOODLIGHTING

NEMO
LED FLOODLIGHTING

- Light Source: Lumileds 5050
- Input Volt: 100-277VAC / 200-240VAC
- IP Rating: IP65 IK08
- Certificates: ETL DLC ENEC TUV CE RoHS CB SAA
- Color Temp: 4000K 5000K 5700K
- Buckle design, tool free open and maintenance
- Buckle and tempered glass all hang to the lamp when opens
- Various lens, PCB board and drivers changeable
- 5 years warranty



▲ **Linkable Floodlights available**

100-277V / 347-480V 50,000H Dimmable -30~45°C IK08 IP65

TENNIS COURT LIGHTING

Anti-Glaring Special for tennis court

5 Years Warranty
50000 Hour Long Service Life

100W / 150W	200W / 240W	300W

Part Number	LSNFL-100W(XXK)	LSNFL-150W(XXK)	LSNFL-200W(XXK)	LSNFL-240W(XXK)	LSNFL-300W(XXK)
Watt	100W	150W	200W	240W	300W
Efficiency	160Lm/W or 180Lm/W	155Lm/W or 185Lm/W	150Lm/W or 180Lm/W	145Lm/W or 180Lm/W	155Lm/W or 180Lm/W
Dimensions (mm)	441x357x60mm	441x357x60mm	447x387x60mm	447x387x60mm	518x477x60mm
Lumen	16,000Lm / 18,000Lm	23,250Lm / 27,750Lm	30,000Lm / 36,000Lm	34,800Lm / 43,200Lm	46,500Lm / 54,000Lm
Driver	XLG-100-H-A	XLG-150-H-A	XLG-240-H-A	XLG-240-H-A	2*XLG-150-H-A



Beam Angle

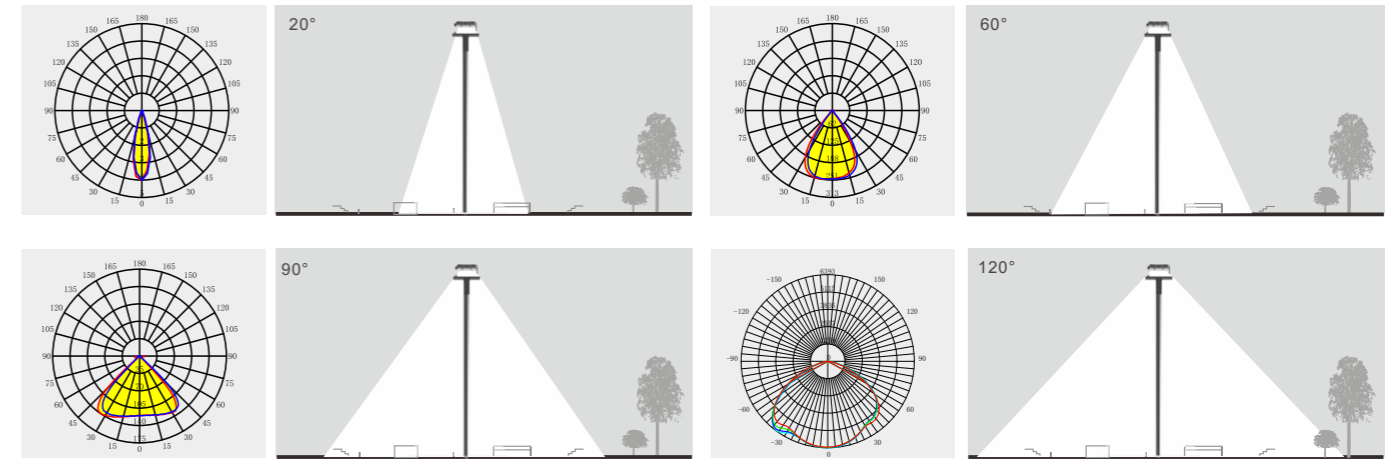

▶ **ACCESSORY: PHOTOCELL** Optional

This fixture is optional with photocell sensor
• Photocell integration controls 120-277Volt



Photocell
On at Dusk and Off at Dawn.

0-10V NEMA dimming

Anti-glare plate

▶ **ACCESSORY: SURGE PROTECTION DEVICE**

This fixture is optional with 10KV or 20KV SPD. SPD surge protection devices is perfectly adapted for outdoor lighting to provide single phase protection for line/neutral, line/ground and neutral/ground in accordance with IEEE C62.41 2002 C High, UL1449 and IEC61643-11

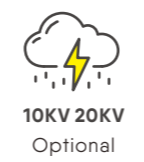

10KV 20KV
Optional



Slip Fitter

Special for tennis court (Anti-Glaring)

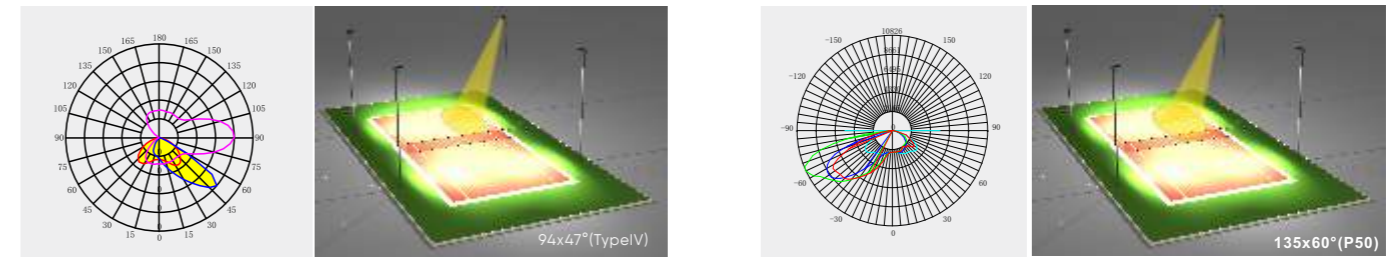

170 Lm/W

NEMO EKO SERIES
LED FLOODLIGHTING



NEMO EKO
LED FLOODLIGHTING

- Light Source: Lumileds 5050
- Input Volt: 100-277VAC / 200-240VAC
- IP Rating: IP65 IK08
- Certificates: ETL DLC ENEC TUV CE RoHS CB SAA
- Color Temp: 4000K 5000K 5700K
- Buckle design, tool free open and maintenance
- Various lens, PCB board and drivers changeable
- 5 years warranty

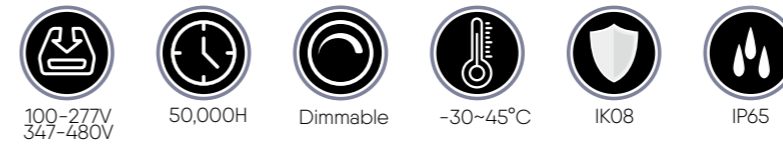

TENNIS COURT LIGHTING

Buckle design, tool free open and maintenance



Part Number	LSNFL-50W(XXX)EKO	LSNFL-75W(XXX)EKO	LSNFL-100W(XXX)EKO	LSNFL-150W(XXX)EKO	LSNFL-200W(XXX)EKO
Watt	50W	75W	100W	150W	200W
Efficiency	150Lm/W or 170Lm/W	145Lm/W or 170Lm/W	145Lm/W or 165Lm/W	160Lm/W or 175Lm/W	165Lm/W or 175Lm/W
Dimensions (mm)	441x357x60mm	441x357x60mm	447x387x60mm	447x387x60mm	518x477x60mm
Lumen	7,500Lm / 8,500Lm	10,875Lm / 12,750Lm	14,500Lm / 16,500Lm	24,000Lm / 26,250Lm	33,000Lm / 35,000Lm
Driver	MNC-100V240	MNC-100V240	MNC-100V240	MNC-150V240	MNC-200V240



Beam Angle

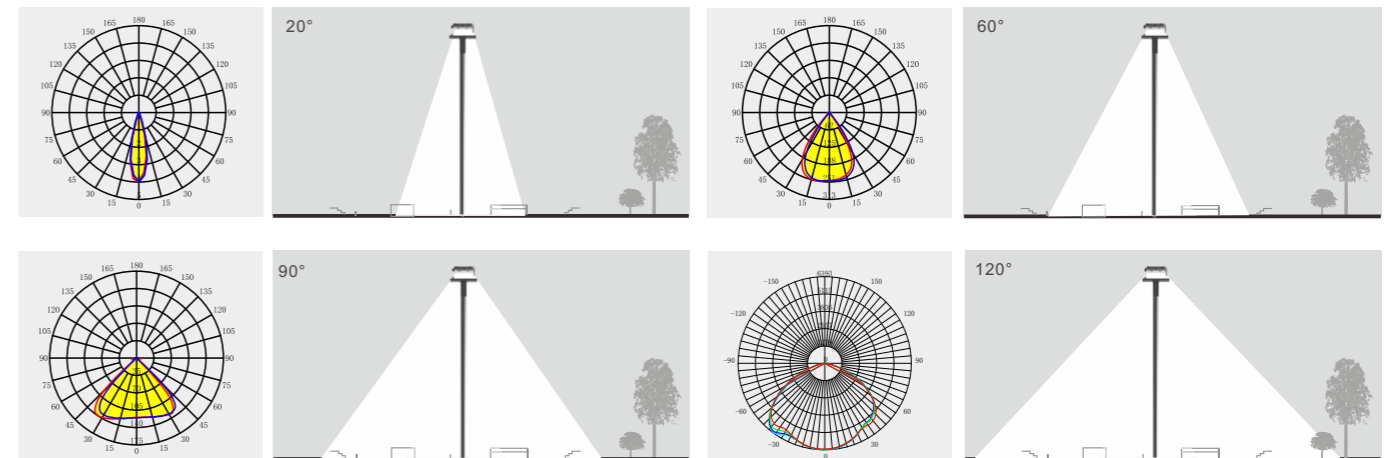

Special for tennis court (Anti-Glaring)

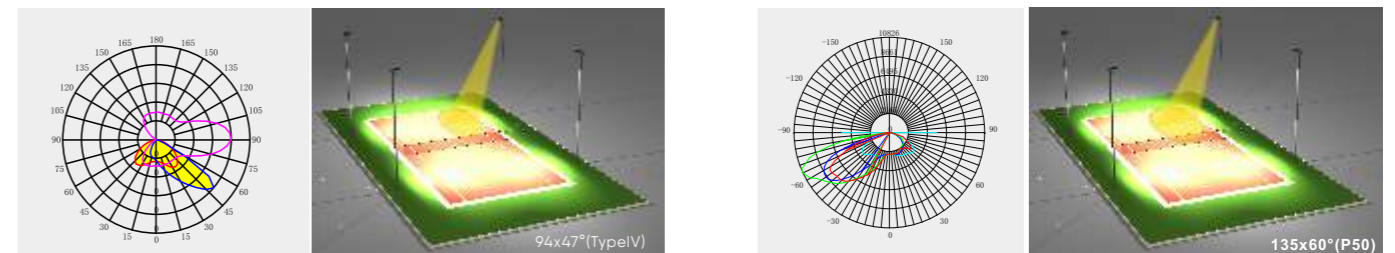

ACCESSORY: PHOTOCELL Optional

This fixture is optional with photocell sensor
 • Photocell integration controls
 120-277Volt



Photocell
 On at Dusk and Off at Dawn.
 NEMA 7Pin



Open tool-free

ACCESSORY: SURGE PROTECTION DEVICE

This fixture is optional with 10KV or 20KV SPD.
 SPD surge protection devices is perfectly adapted for outdoor lighting to provide single phase protection for line/neutral, line/ground and neutral/ground in accordance with IEEE C62.41 2002 C High, UL1449 and IEC61643-11



10KV 20KV
 Optional

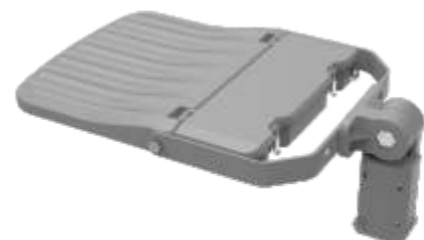

Slip Fitter

150 Lm/W

SLIM SERIES

LED FLOODLIGHT 10W - 400W



SILM LED FLOODLIGHT

- Light Source: Lumileds 3030
- Input Volt: 100-277VAC
- IP Rating : IP65
- Beam Angle: 120°
- Color Temp: 3000K 4000K 5000K 5700K
- Certificate: CE RoHS SAA ETL DLC
- Optional Beam Angle: 8° 15° 30° 60° 90°
- 5 years warranty



LED FLOOD LIGHT

die-cast aluminum enclosure resists corrosion, dust, insects, and weather



Part Number	LSSFL-10W	LSSFL-20W	LSSFL-30W	LSSFL-50W	LSSFL-80W
Watt	10W	20W	30W	50W	80W
Efficiency	100LM/W±3%	100LM/W±3%	100LM/W±3%	130LM/W / 150LM/W	120LM/W / 150LM/W
Dimensions (mm)	6.5x4.6x1.3"	8.5x6.0x1.6"	8.9x6.6x1.6"	12.2x8.7x2.0"	13.9x9.6x2.2"
Lumen	1,000Lm	2,000Lm	3,000Lm	5,000Lm / 7,500Lm	9,600Lm / 12,000Lm
Driver	TUV CE Driver	TUV CE Driver	TUV CE Driver	TUV CE Driver	XLG-100-H-A
Weight	0.48Kg	0.85Kg	1.17Kg	1.89Kg	4.7Kg

Part Number	LSSFL-100W	LSSFL-150W	LSSFL-200W	LSSFL-300W	LSSFL-400W
Watt	100W	150W	200W	300W	400W
Efficiency	120LM/W / 150LM/W	120LM/W / 150LM/W	120LM/W / 150LM/W	130LM/W / 150LM/W	130LM/W / 150LM/W
Dimensions (in)	15.8x11.6x2.4"	16.9x13x2.4"	18.5x14.2x2.4"	18"x2.55"x22.24"	22"x2.75"x23"
Lumen	12,000Lm / 15,000Lm	18,000Lm / 22,500Lm	24,000Lm / 30,000Lm	39,000Lm / 45,000Lm	52,000Lm / 60,000Lm
Driver	XLG-100-H-A	XLG-150-H-A	XLG-240-H-A	2*XLG-150-H-A	2*XLG-240-H-A
Weight	5.48Kg	6.90Kg	8.26Kg	10.6Kg	15.3Kg



Beam Angle

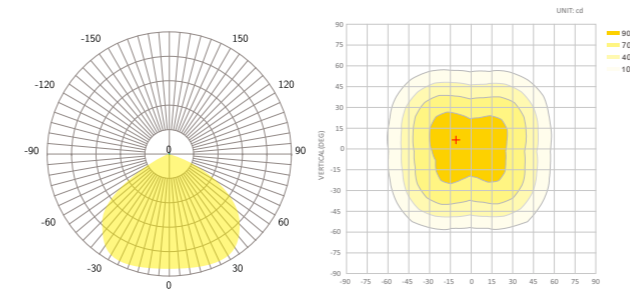

120°

170 Lm/W

SLIM SERIES

LED FLOODLIGHT 50W - 400W



LED FLOOD LIGHT

die-cast aluminum enclosure resists corrosion, dust, insects, and weather

5 Years Warranty
10000 Hour Long Service Life



Slip Fitter



Optional Photocell

SILM LED FLOODLIGHT

- Light Source: Lumileds 5050
- Input Volt: 100-277VAC
- IP Rating : IP65
- Beam Angle: 120°
- Color Temp: 3000K 4000K 5000K 5700K
- Certificate: CE RoHS SAA ETL DLC
- Optional Beam Angle: 8° 15° 30° 60° 90°
- 5 years warranty



Part Number	LSSFL-50W	LSSFL-80W	LSSFL-100W	LSSFL-150W
Watt	50W	80W	100W	150W
Efficiency	170LM/W±3%	170LM/W±3%	170LM/W±3%	170LM/W±3%
Dimensions (mm)	12.2x8.7x2.0"	13.9x9.6x2.2"	15.8x11.6x2.4"	16.9x13x2.4"
Lumen	8,500Lm	13,600Lm	17,000Lm	25,500Lm
Driver	TUV CE Driver	XLG-100-H-A	XLG-100-H-A	XLG-150-H-A
Weight	1.89Kg	4.7Kg	5.48Kg	6.90Kg

Part Number	LSSFL-200W	LSSFL-300W	LSSFL-400W
Watt	200W	300W	400W
Efficiency	170LM/W±3%	170LM/W±3%	170LM/W±3%
Dimensions (in)	18.5x14.2x2.4"	18"x2.55"x22.24"	22"x2.75"x23"
Lumen	34,000Lm	51000Lm	68,000Lm
Driver	XLG-240-H-A	2*XLG-150-H-A	2*XLG-240-H-A
Weight	8.26Kg	10.6Kg	15.3Kg



Beam Angle

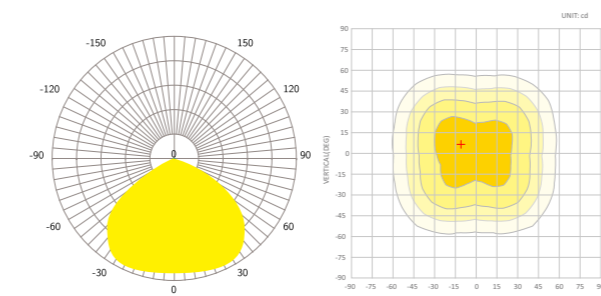

120°

HOT

170 Lm/W

SLIM EKO SERIES
LED FLOODLIGHT 30W - 200W



SLIM EKO LED FLOOD LIGHT

die-cast aluminum enclosure resists corrosion, dust, insects, and weather

5 Years Warranty
100000 Hour Long Service Life

Optional Accessories



Slip Fitter



Photocell sensor



1-10V Dimmable



SPD 10KV or 20KV



Photocell



Short Circuit Cap



NEMA 7pin



SILM EKO

LED FLOODLIGHT

- Light Source: Lumileds 3030
- Input Volt: 100-277VAC
- IP Rating : IP66
- Beam Angle: 120°
- Color Temp: 3000K 4000K 5000K 5700K
- Certificate: CE RoHS SAA ETL DLC
- Optional Beam Angle: 90°
- 5 years warranty



Part Number	LSSFL-30W	LSSFL-50W	LSSFL-100W	LSSFL-150W	LSSFL-200W
Watt	30W	50W	100W	150W	200W
Efficiency	130LM/W	130LM/W	130LM/W	130LM/W	130LM/W
Dimensions	250x214x53mm	291x254x51mm	354x319x50mm	400x359x60mm	430x389x63mm
Lumen	3,900Lm	6,500Lm	13,000Lm	19,500Lm	26,000Lm
Driver	CE Driver	CE Driver	MNC-100V240	MNC-150V240	MNC-200V240
Weight	5.48Kg	6.90Kg	8.26Kg	10.6Kg	15.3Kg

Part Number	LSSFL-50W	LSSFL-100W	LSSFL-150W	LSSFL-200W
Watt	50W	100W	150W	200W
Efficiency	150LM/W	150LM/W / 170LM/W	150LM/W / 170LM/W	150LM/W / 170LM/W
Dimensions	291x254x51mm	354x319x50mm	400x359x60mm	430x389x63mm
Lumen	7,500Lm	15,000Lm / 17,000Lm	22,500Lm / 25,500Lm	30,000Lm / 34,000Lm
Driver	CE Driver	MNC-100V240	MNC-150V240	MNC-200V240
Weight	6.90Kg	8.26Kg	10.6Kg	15.3Kg



Beam Angle

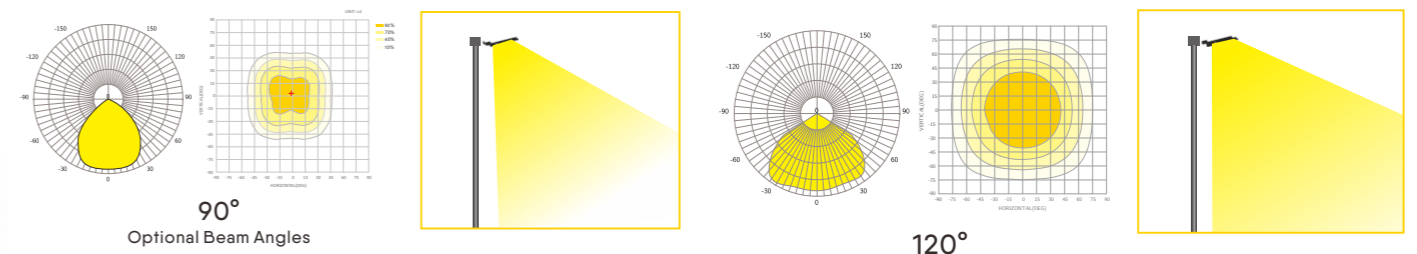

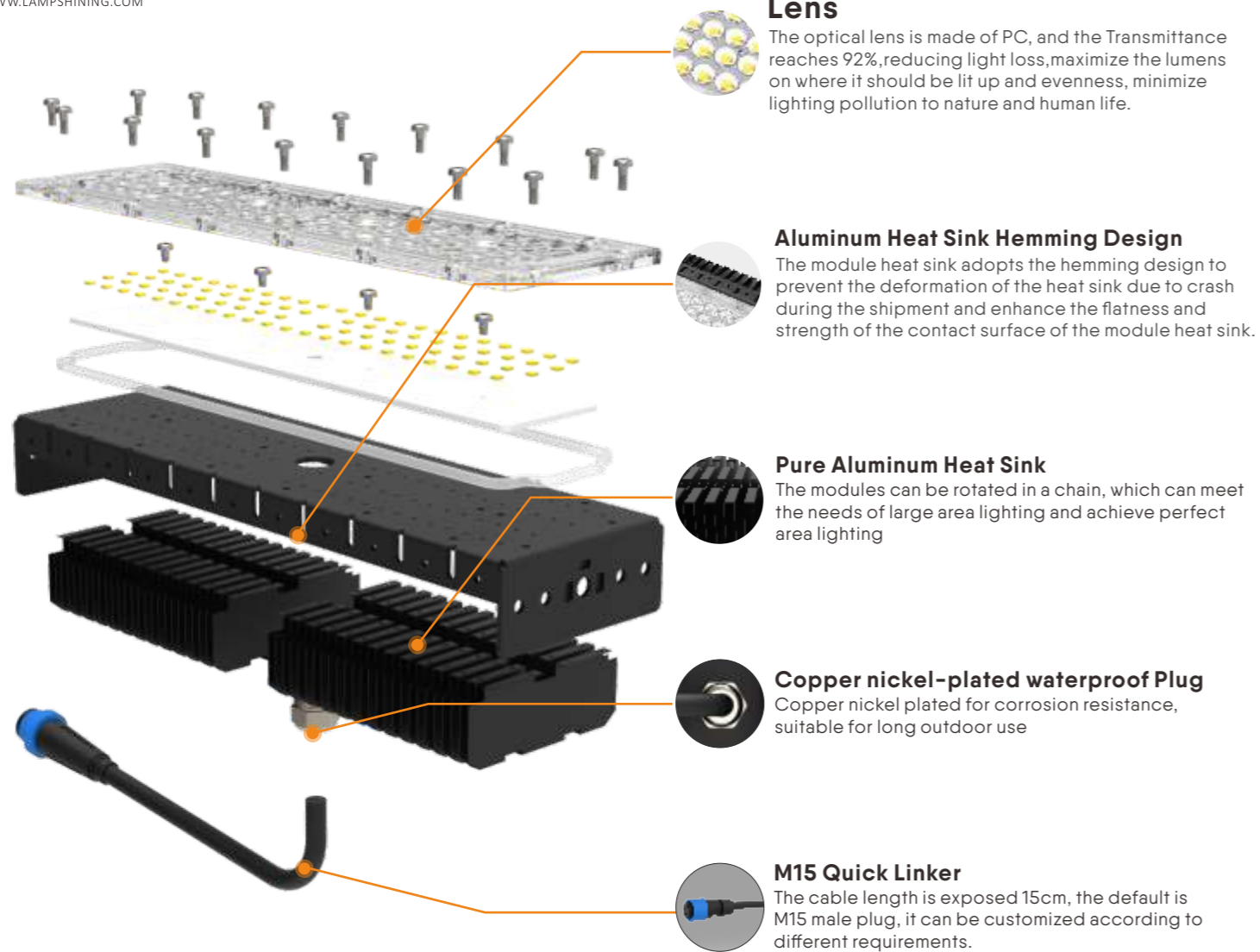

Lens
The optical lens is made of PC, and the Transmittance reaches 92%, reducing light loss, maximize the lumens on where it should be lit up and evenness, minimize lighting pollution to nature and human life.

Aluminum Heat Sink Hemming Design
The module heat sink adopts the hemming design to prevent the deformation of the heat sink due to crash during the shipment and enhance the flatness and strength of the contact surface of the module heat sink.

Pure Aluminum Heat Sink
The modules can be rotated in a chain, which can meet the needs of large area lighting and achieve perfect area lighting

Copper nickel-plated waterproof Plug
Copper nickel plated for corrosion resistance, suitable for long outdoor use

M15 Quick Linker
The cable length is exposed 15cm, the default is M15 male plug, it can be customized according to different requirements.



PRO E

Folding Aluminum Fin SMD 3030 LED Module

140LM/W 170LM/W

50W

Folding Aluminum fin design which are very light weight. Increase the heat dissipation surface area by air cooling to dissipate heat and expand the contact area with air! It speeds up the spread of heat! Thermal effect is good!



PRO E

LED FIN MODULE LIGHT

FOLDING ALUMINUM FIN DESIGN



- Light Source: Luminleds 3030
- Input Volt: 42VDC
- IP Rating IK Rating : IP66 & IK10
- Beam Angle: 15° 25° 40° 60° 90° 120°
30x70° 49x21° 136x78°
- Color Temp: 3000K 4000K 5000K 5700K 6000K
- Plug: M15 2Pin Male Plug
- 5 years warranty

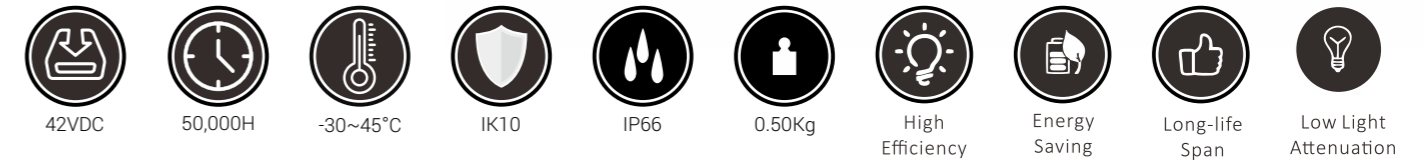

Technical Specifications

Part Number	Watt	Driver	Efficiency	Chip Brand	Lumen	CCT	Net Weight
LSM-50W-PROE	50W	Not included	140LM/W±3%	Luminleds 3030	7,000Lm	3000-6000K	0.5KG
LSM-50W-PROE	50W	Not included	170LM/W±3%	Luminleds 3030	8,500Lm	3000-6000K	0.5KG

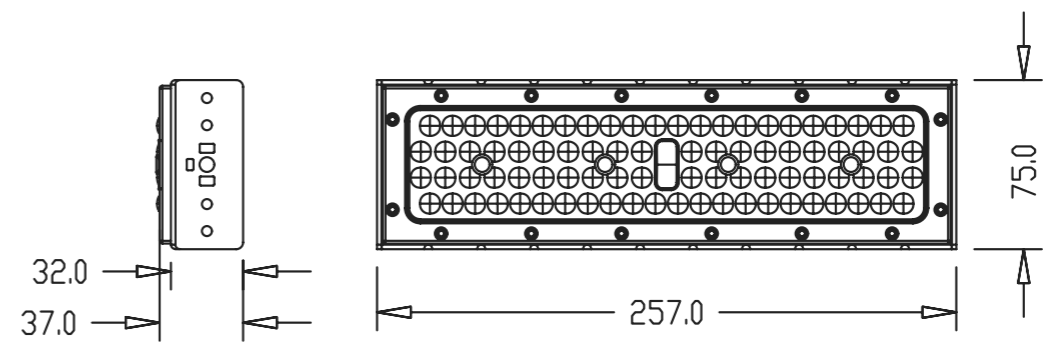

Unit: mm

Beam Angle

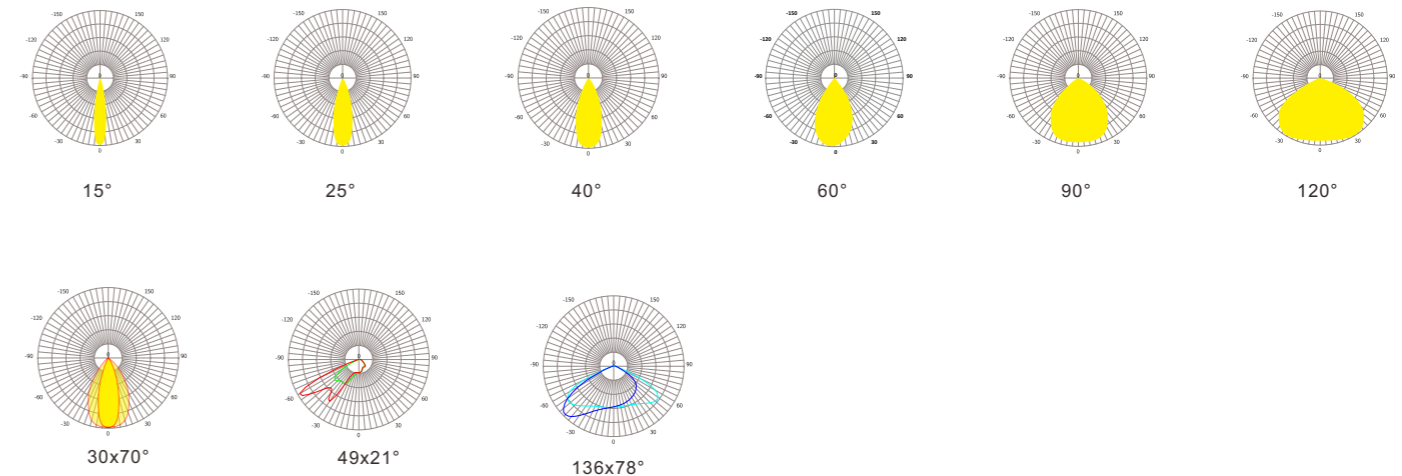

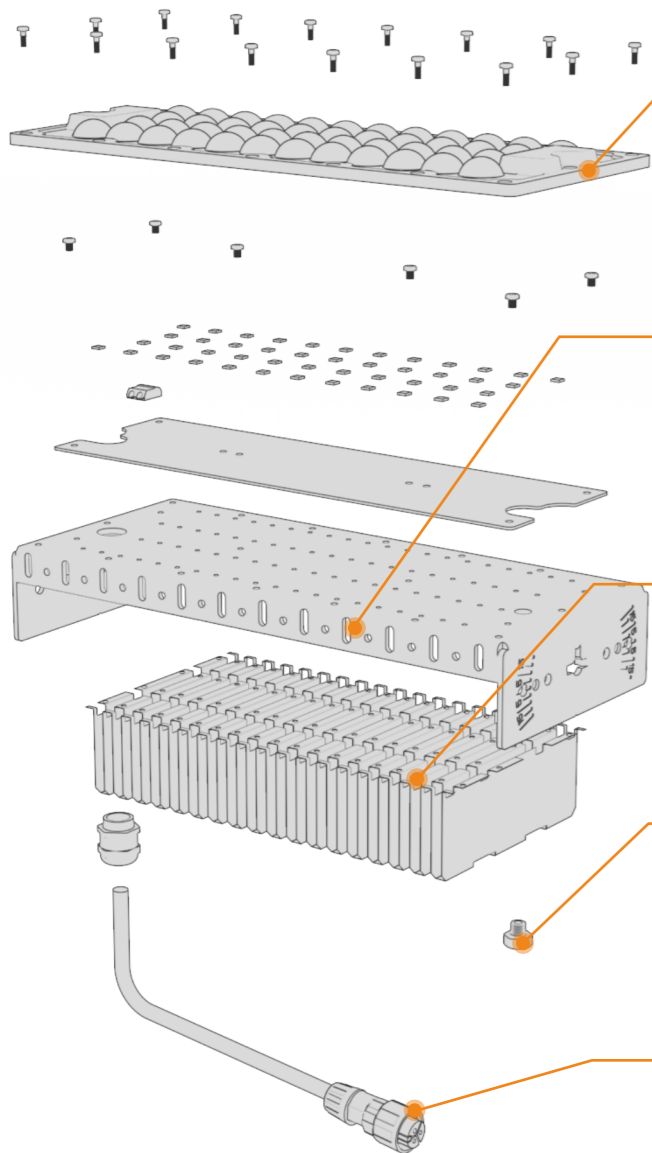

Lens
The optical lens is made of PC, and the Transmittance reaches 92%, reducing light loss, maximize the lumens on where it should be lit up and evenness, minimize lighting pollution to nature and human life.

Aluminum Heat Sink Hemming Design
The module heat sink adopts the hemming design to prevent the deformation of the heat sink due to crash during the shipment and enhance the flatness and strength of the contact surface of the module heat sink.

Pure Aluminum Heat Sink
The modules can be rotated in a chain, which can meet the needs of large area lighting and achieve perfect area lighting

Breathable Protective Air Vent Plug
Each Module of comes with Waterproof Breathable Pressure Relief Vent Plug

M15 Quick Linker
The cable length is exposed 15cm, the default is M15 male plug, it can be customized according to different requirements.



SLIM PRO

Folding Aluminum Fin SMD 5050 LED Module

175LM/W
100W 120W

Folding Aluminum fin design which are very light weight. Increase the heat dissipation surface area by air cooling to dissipate heat and expand the contact area with air! It speeds up the spread of heat! Thermal effect is good!



PRO A

LED FIN MODULE LIGHT

FOLDING ALUMINUM FIN DESIGN

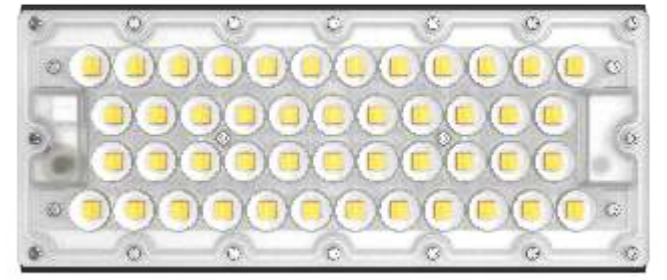

- Light Source: Luminleds 5050
- Input Volt: 46-48VDC
- IP Rating IK Rating : IP66 & IK10
- Beam Angle: 10° 20° 40° 60° 90° 30x70° 140x100° 135x60°(P50)
- Color Temp: 3000K 4000K 5000K 5700K 6000K
- Plug: M15 2Pin Male Plug
- 5 years warranty

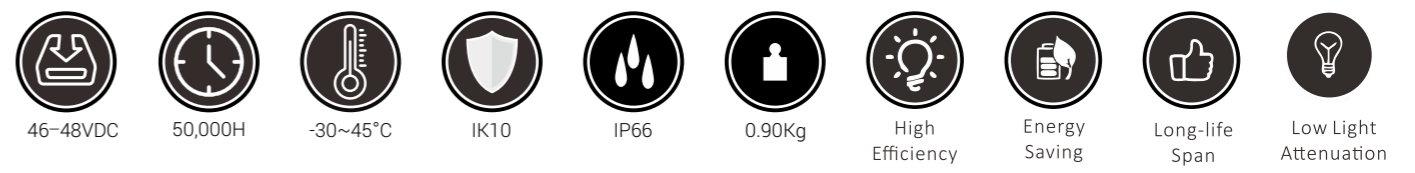

Technical Specifications

Part Number	Watt	Driver	Efficiency	Chip Brand	Lumen	CCT	Net Weight
LSM-100W-PRO	100W	Not included	160LM/W±3%	Luminleds 5050	16,000Lm	3000-6000K	0.9KG
LSM-120W-PRO	120W	Not included	155LM/W±3%	Luminleds 5050	18,600Lm	3000-6000K	0.9KG
LSM-100W-PRO	100W	Not included	175LM/W±3%	Luminleds 5050	17,500Lm	4000-5000K	0.9KG
LSM-120W-PRO	120W	Not included	175LM/W±3%	Luminleds 5050	21,000Lm	4000-5000K	0.9KG

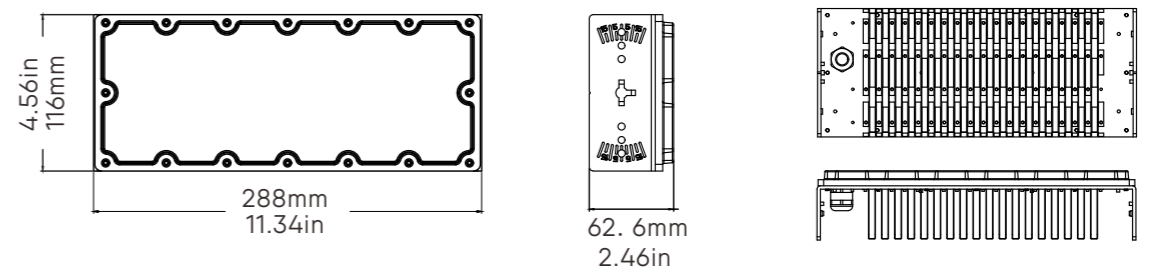

Beam Angle

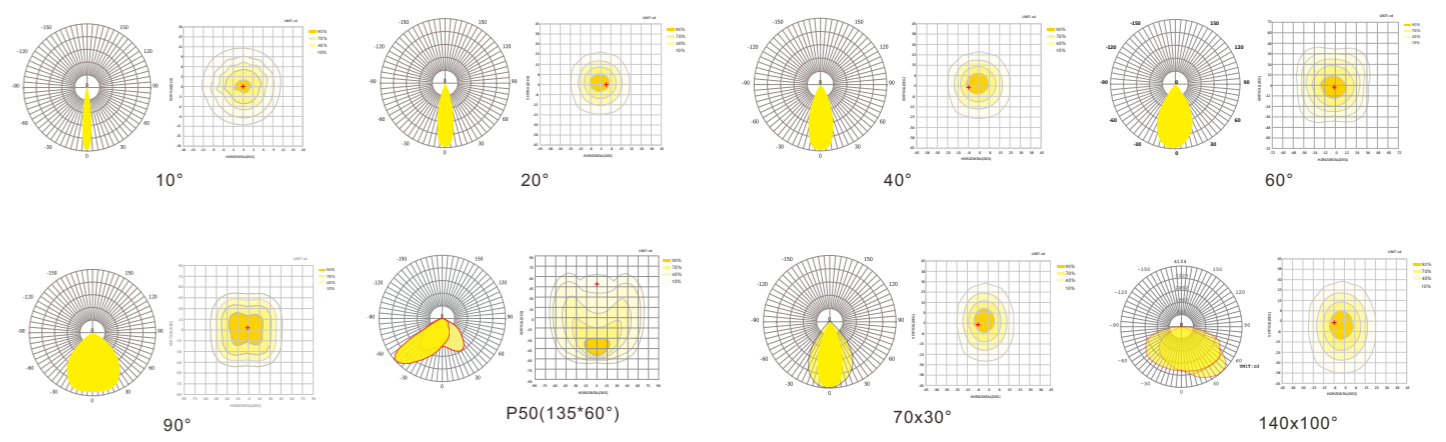

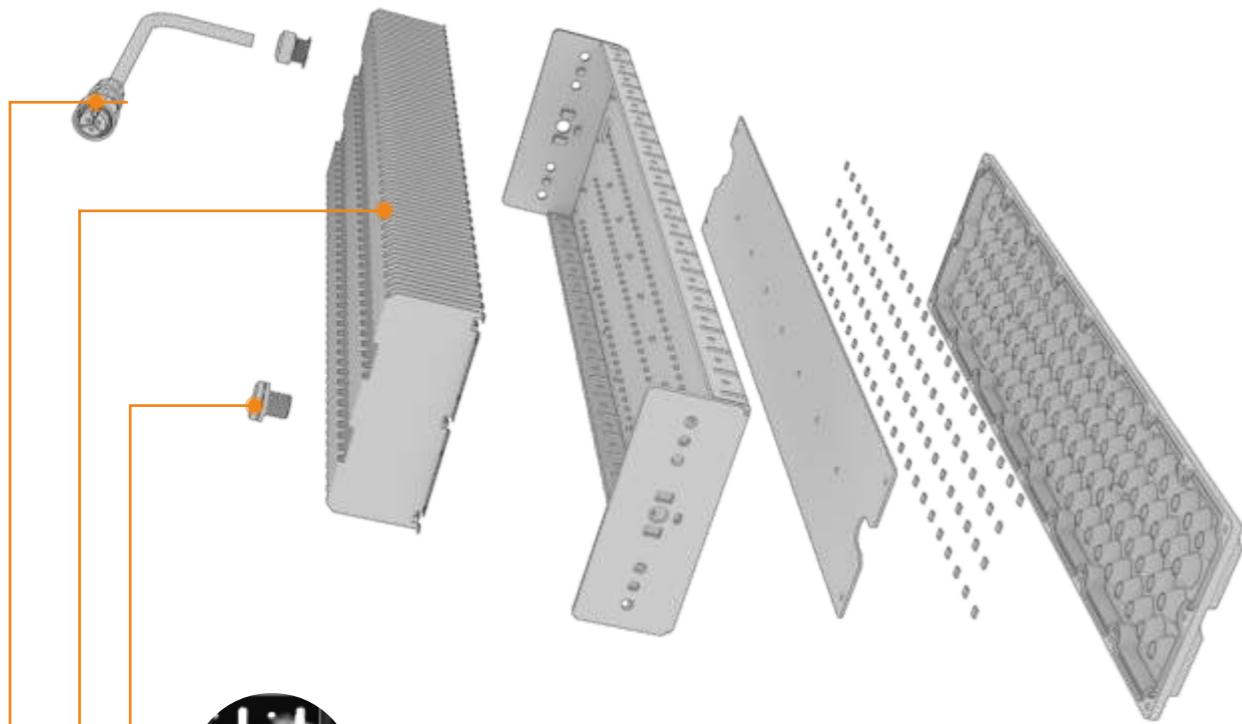

Breathable Protective Air Vent Plug
Each Module of comes with Waterproof Breathable Pressure Relief Vent Plug

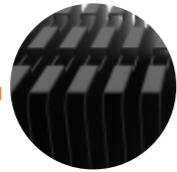

Pure aluminum heat sink
The modules can be rotated in a chain, which can meet the needs of large area lighting and achieve perfect area lighting

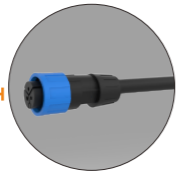

M15 Quick Linker
The cable length is exposed 15cm, the default is M15 male plug, it can be customized according to different requirements.

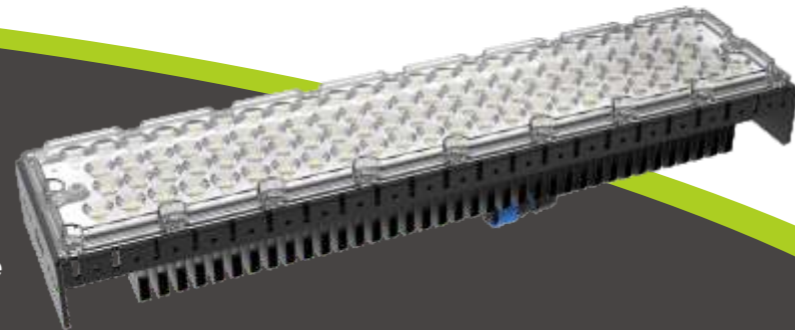

SLIM PRO

Folding Aluminum Fin SMD 5050 LED Module

175LM/W

200W 240W

Folding Aluminum fin design which are very light weight. Increase the heat dissipation surface area by air cooling to dissipate heat and expand the contact area with air! It speeds up the spread of heat! Thermal effect is good!



PROB

LED FIN MODULE LIGHT

FOLDING ALUMINUM FIN DESIGN

- Light Source: Luminleds 5050 / Osram 5050
- Input Volt: 46-48VDC
- IP Rating IK Rating : IP66 & IK10
- Beam Angle: 10° 20° 40° 60° 90° 30x70° 140x100° 135x60° (P50)
- Color Temp: 3000K - 6000K
- Plug: M15 2Pin Male Plug
- 5 years warranty



46-48VDC



50,000H



-30~45°C



IK10



IP66



1.98Kg



High Efficiency



Energy Saving



Long-life Span



Low Light Attenuation

Technical Specifications

Part Number	Watt	Driver	Efficiency	Chip Brand	Lumen	CCT	Net Weight
LSM-200W-PRO	200W	Not included	160LM/W±3%	Luminleds 5050	32,000Lm	3000-6000K	1.98KG
LSM-240W-PRO	240W	Not included	155LM/W±3%	Luminleds 5050	37,200Lm	3000-6000K	1.98KG
LSM-200W-PRO	200W	Not included	175LM/W±3%	Luminleds 5050	35,000Lm	4000-5000K	1.98KG
LSM-240W-PRO	240W	Not included	175LM/W±3%	Luminleds 5050	42,000Lm	4000-5000K	1.98KG

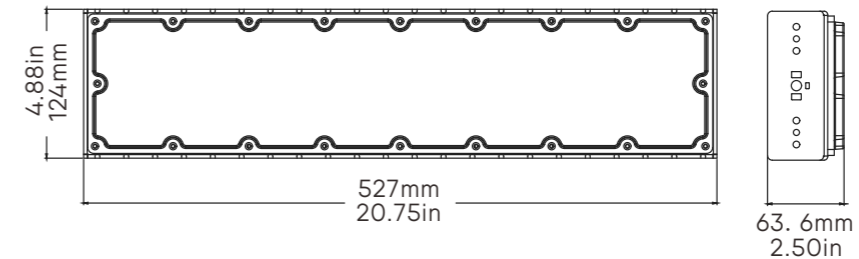

Beam Angle

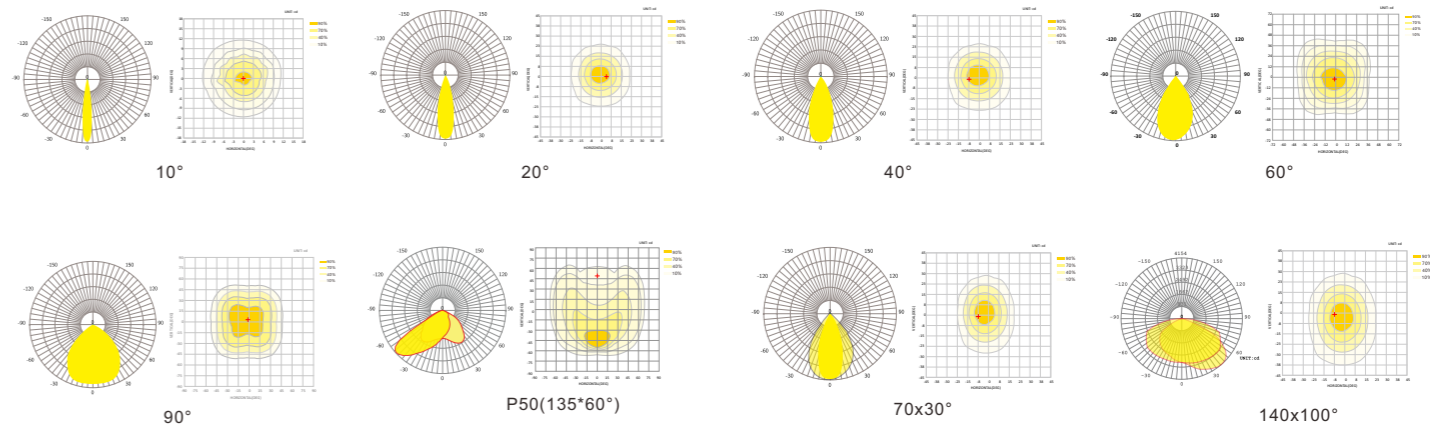

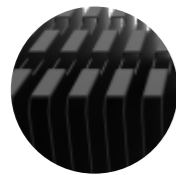
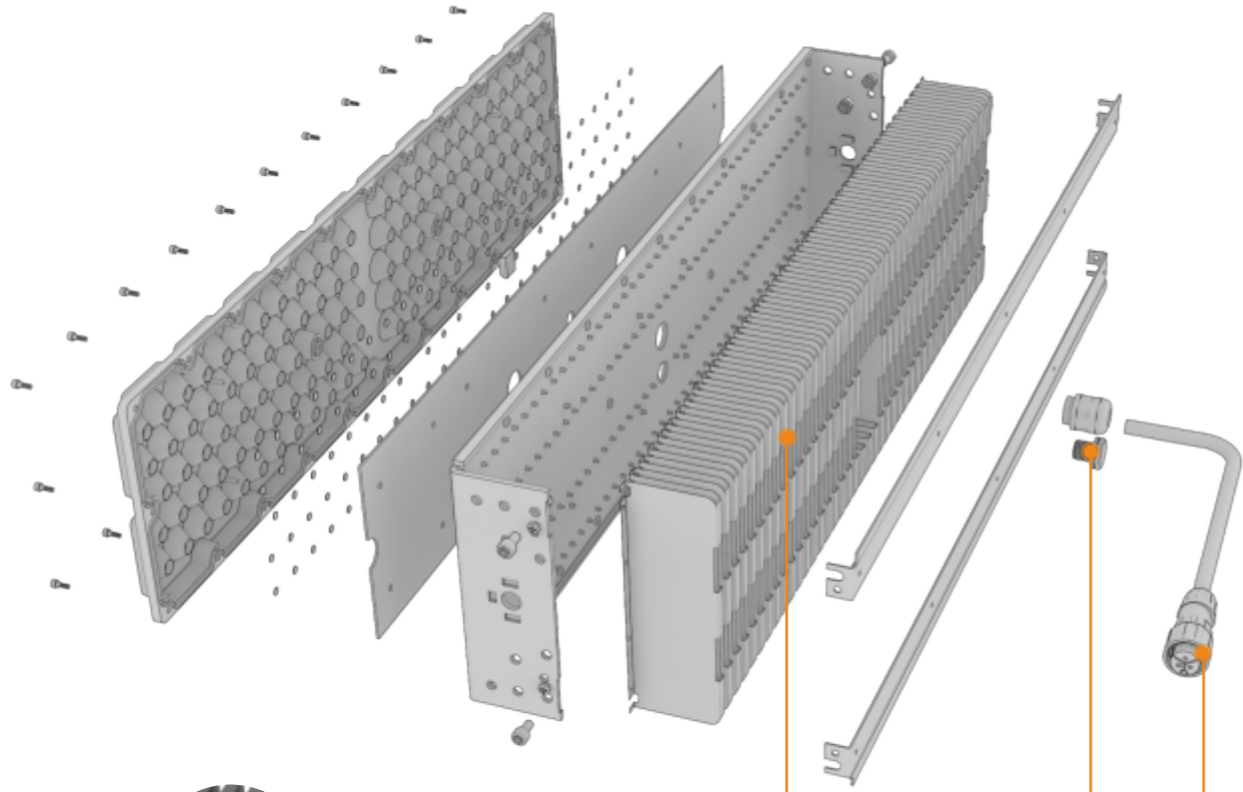

Pure aluminum heat sink

The modules can be rotated in a chain, which can meet the needs of large area lighting and achieve perfect area lighting



Breathable Protective Air Vent Plug

Each Module of comes with Waterproof Breathable Pressure Relief Vent Plug

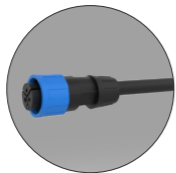

M15 Quick Linker

The cable length is exposed 15cm, the default is M15 male plug, it can be customized according to different requirements.

PLUS

**LED FIN MODULE LIGHT
FOLDING ALUMINUM FIN DESIGN**

- Light Source: Luminleds 5050 / Osram 5050
- Input Volt: 46-48VDC
- IP Rating IK Rating : IP66 & IK10
- Beam Angle: 10° 20° 40° 60° 140x100° 135x60°(P50)
- Color Temp: 3000K 4000K 5000K 5700K 6000K
- Plug: M15 2Pin Male Plug
- 5 years warranty



46-48VDC	50,000H	-30~45°C	IK10	IP66	2.05Kg	High Efficiency	Energy Saving	Long-life Span	Low Light Attenuation

Technical Specifications

Part Number	Watt	Dtiver	Efficiency	Chip Brand	Lumen	CCT	Net Weight
LSM-200W-PLUS	200W	Not included	180LM/W±3%	Luminleds 5050	36,000Lm	4000-5000K	2.05KG
LSM-240W-PLUS	240W	Not included	170LM/W±3%	Luminleds 5050	40,800Lm	3000-6000K	2.05KG
LSM-300W-PLUS	300W	Not included	160LM/W±3%	Luminleds 5050	48,000Lm	3000-6000K	2.05KG

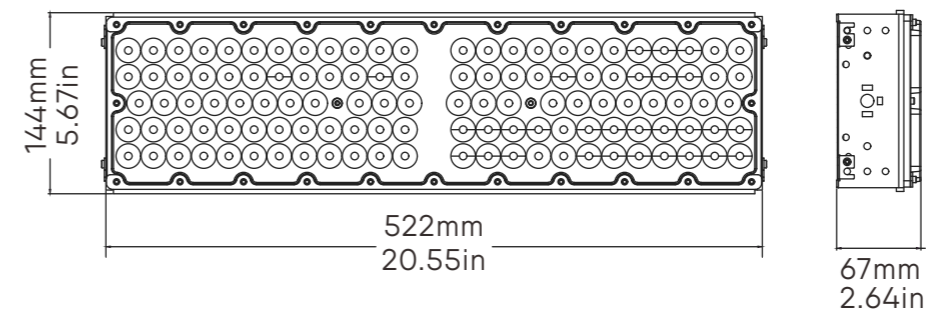

Beam Angle

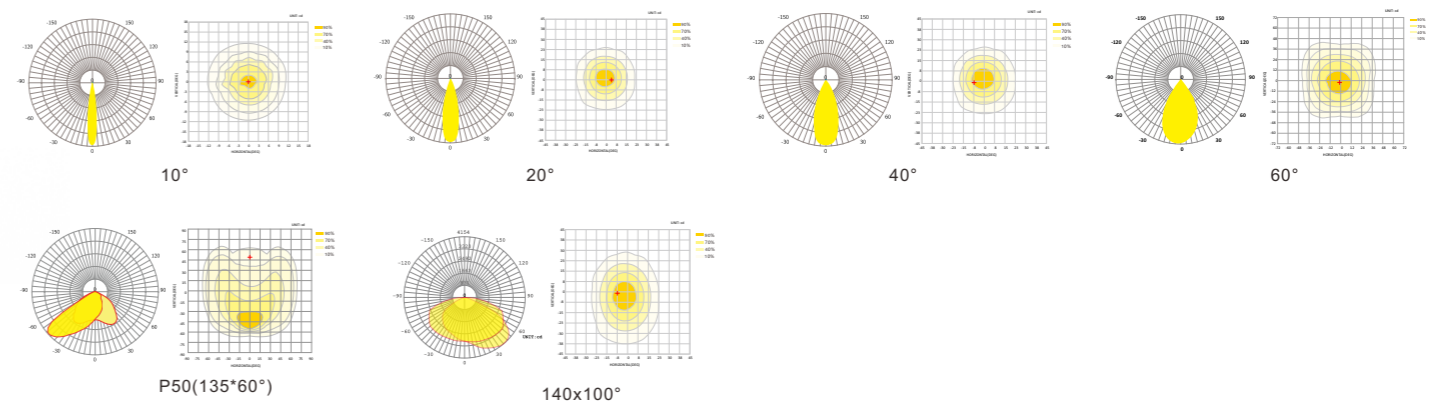

SLIM PLUS

Folding Aluminum Fin SMD 5050 LED Module

180LM/W

200W 240W 300W

Folding Aluminum fin design which are very light weight. Increase the heat dissipation surface area by air cooling to dissipate heat and expand the contact area with air! It speeds up the spread of heat! Thermal effect is good!



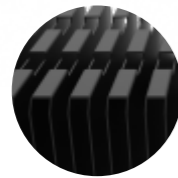
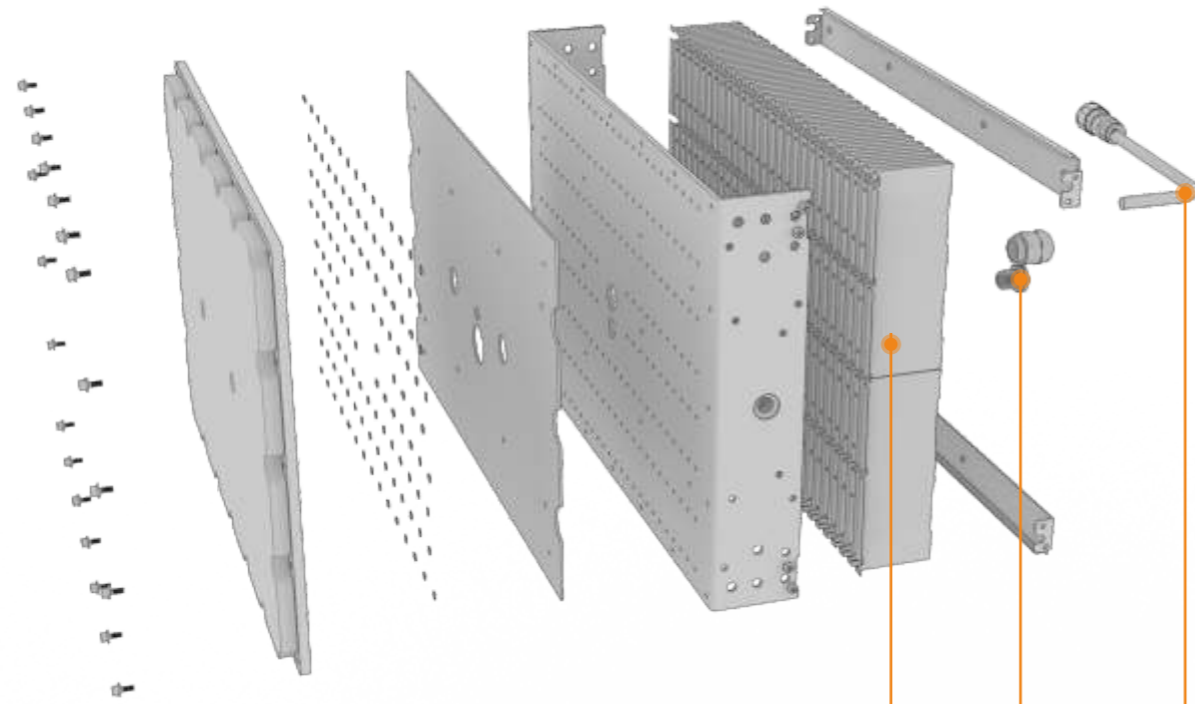

Pure aluminum heat sink

The modules can be rotated in a chain, which can meet the needs of large area lighting and achieve perfect area lighting

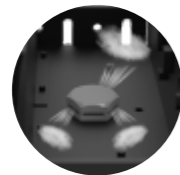

Breathable Protective Air Vent Plug

Each Module of comes with Waterproof Breathable Pressure Relief Vent Plug

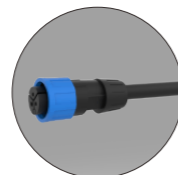

M15 Quick Linker

The cable length is exposed 15cm, the default is M15 male plug, it can be customized according to different requirements.



MAX

Folding Aluminum Fin SMD 5050 LED Module

200LM/W

200W 240W 300W

Folding Aluminum fin design which are very light weight. Increase the heat dissipation surface area by air cooling to dissipate heat and expand the contact area with air! It speeds up the spread of heat! Thermal effect is good!



MAX

LED FIN MODULE LIGHT

FOLDING ALUMINUM FIN DESIGN

- Light Source:Luminleds 5050
- Input Volt: 46-48VDC
- IP Rating IK Rating : IP66 & IK10
- Beam Angle: 20° 40° 60°
- Color Temp:3000-6000K
- Plug: M15 2Pin Male Plug
- 5 years warranty

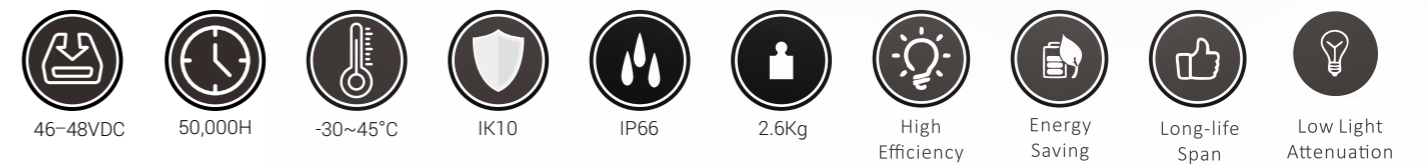

Technical Specifications

Part Number	Watt	Driver	Efficiency	Chip Brand	Lumen	CCT	Net Weight
LSM-200W-MAX	200W	Not included	200LM/W±3%	Luminleds 5050	40,000Lm	4000-5000K	2.6KG
LSM-240W-MAX	240W	Not included	180LM/W±3%	Luminleds 5050	43,200Lm	3000-6000K	2.6KG
LSM-300W-MAX	300W	Not included	170LM/W±3%	Luminleds 5050	51,000Lm	3000-6000K	2.6KG

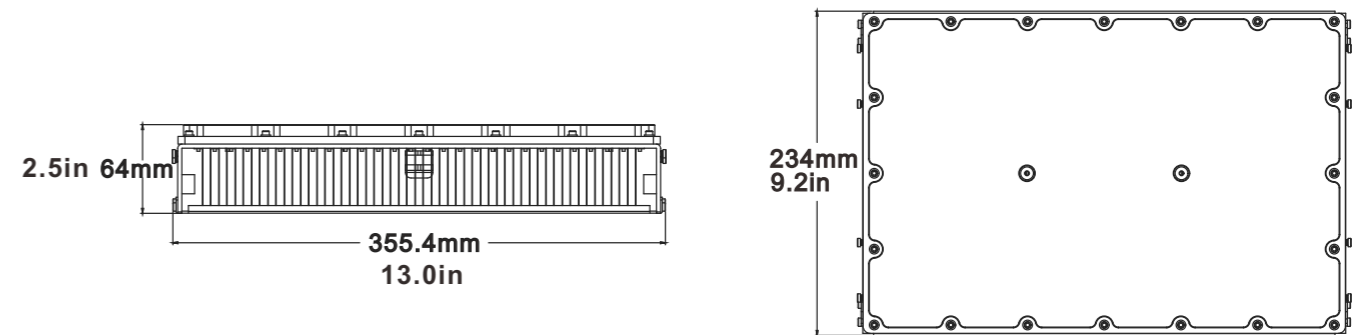

Beam Angle

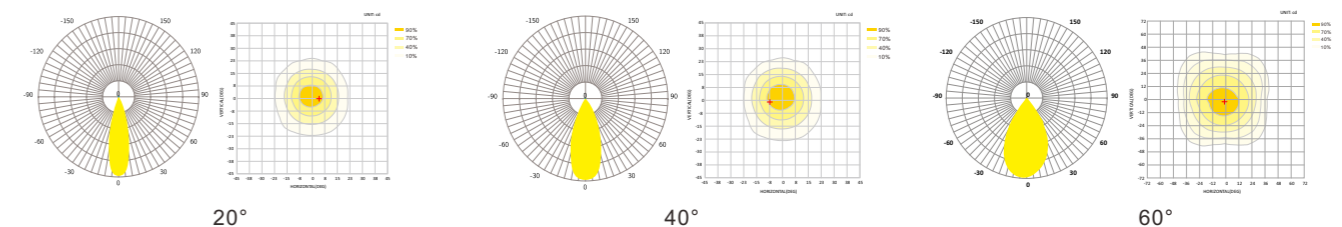



SHOEBOX SERIES AREA LIGHTS | LED PARKING LOT LIGHTS

- Optional photocontrol sensor for dusk to dawn operation
- LED pole light has standard arm mount for square and round poles
- Instant start, no flickering, no humming
- Low profile, corrosion resistant, heavy duty die-cast aluminum housing
- IP65 rated housing
- UV-resistant, multi-layer, architectural color, bronze powder coat finish
- Straight Pole Arm, Round Pole Mount, Slip fitter or Wall Mount.
- 5 years warranty

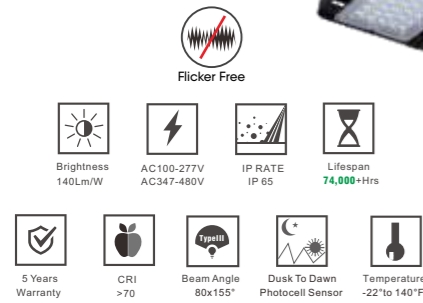

TECHNICAL PARAMETERS

Light Source	Lumileds 5050 / CREE 3030
Power Factor	>0.95
Input Voltage	100-277VAC / 347-480VAC
CCT	3000K/4000K/5000K/5700K/6500K
IP Rating	IP65
Beam Angle	80x155°(TypeIII)
Lifetime	74,000+ hours
Certificate	ETL cETL DLC Premium CE RoHS



SPECIFICATIONS INFORMATION

Model	Watt	Input Voltage	Efficiency	Lumen	Driver	Chip Brand
LSSB-100W-LV(XXK)	100W	100-277VAC	130LM/W±3%	13,000Lm	SS-100VA-56	CREE 3030
LSSB-150W-LV(XXK)	150W	100-277VAC	130LM/W±3%	19,500Lm	SS-150VA-56	CREE 3030
LSSB-300W-LV(XXK)	300W	100-277VAC	130LM/W±3%	39,000Lm	2*SS-150VA-56	CREE 3030
LSSB-100W-HV(XXK)	100W	100-277VAC	170LM/W±3%	17,000Lm	SS-100VA-56	Lumileds 5050
LSSB-150W-HV(XXK)	150W	100-277VAC	170LM/W±3%	25,500Lm	SS-150VA-56	Lumileds 5050
LSSB-300W-HV(XXK)	300W	100-277VAC	170LM/W±3%	51,000Lm	2*SS-150VA-56	Lumileds 5050

Model	Watt	Input Voltage	Efficiency	Lumen	Driver	Dimensions (in)
LSSB-100W-LV(XXK)	100W	347-480VAC	140LM/W±3%	14,000Lm	SS-100M-56BH	CREE 3030
LSSB-150W-LV(XXK)	150W	347-480VAC	140LM/W±3%	21,000Lm	SS-150M-56BH	CREE 3030
LSSB-300W-LV(XXK)	300W	347-480VAC	140LM/W±3%	42,000Lm	SS-320M-56BH	CREE 3030
LSSB-100W-HV(XXK)	100W	347-480VAC	170LM/W±3%	17,000Lm	SS-100M-56BH	Lumileds 5050
LSSB-150W-HV(XXK)	150W	347-480VAC	170LM/W±3%	25,500Lm	SS-150M-56BH	Lumileds 5050
LSSB-300W-HV(XXK)	300W	347-480VAC	170LM/W±3%	51,000Lm	SS-320M-56BH	Lumileds 5050



HEXAGON SERIES LED PARKING LOT RETROFIT KITS

- With a big Sunon fan.
- With beam angle 120 degree.
- Original super bright 3030 LED
- Arm adjustable with any beam angle.
- With the most excellent quality meanwell driver.
- Available for street light fixtures application.
- Using aluminum fin heat sink which heat transfer faster than die cast.



TECHNICAL PARAMETERS

Light Source	Lumileds SMD 3030
Power Factor	>0.95
Input Voltage	100-277VAC / 347-480VAC
CCT	3000K/4000K/5000K/5700K/6500K
IP Rating	IP65
Beam Angle	120°
Lifetime	50,000+ hours
Certificate	ETL cETL CE RoHS

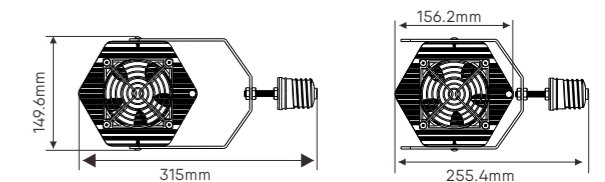
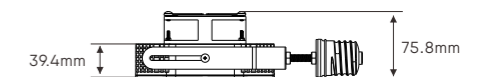
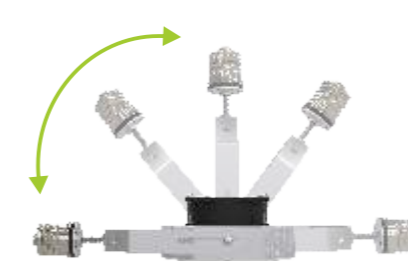
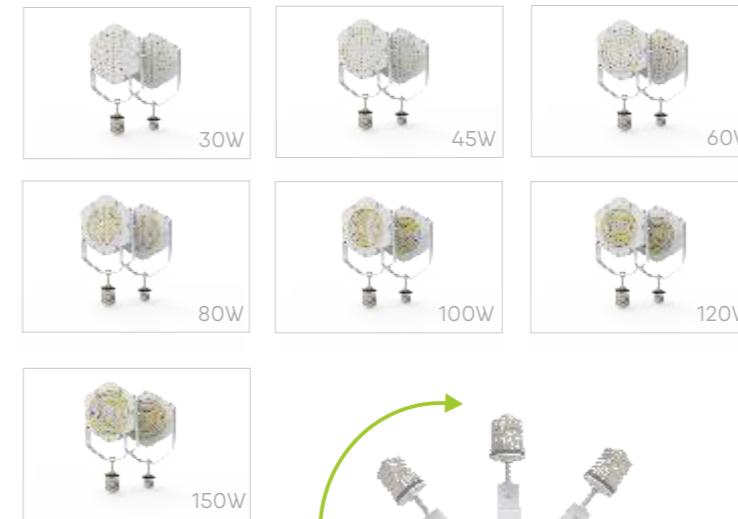

SPECIFICATIONS INFORMATION

Model	Watt	Input Voltage	Efficiency	Lumen	Driver	Replacement
LSRK-30WXY	30W	100-277VAC	130LM/W±3%	4,300Lm	FD-36H-038	75-105W MH HPS
LSRK-45WXY	45W	100-277VAC	130LM/W±3%	6,480Lm	FD-55H-038	105-125W MH HPS
LSRK-60WXY	60W	100-277VAC	130LM/W±3%	8,640Lm	FD-80H-038	150-175W MH HPS
LSRK-80WXY	80W	100-277VAC	130LM/W±3%	11,520Lm	ELG-100-48A	250-275W MH HPS
LSRK-100WXY	100W	100-277VAC	130LM/W±3%	14,400Lm	ELG-100-48A	300-350W MH HPS
LSRK-120WXY	120W	100-277VAC	130LM/W±3%	15,600Lm	ELG-150-48A	350-400W MH HPS
LSRK-150WXY	150W	100-277VAC	130LM/W±3%	21,000Lm	ELG-150-48A	450-500W MH HPS



CORN SERIES LED RETROFIT LIGHT BULBS

- Long life span and less brightness degradation.
- Efficiency of power supply is more than 90%.
- No magnetic disturbance influence.
- No UV and near-IR radiation in the light beam.
- Driver is fulfilled with solid thermal grease.
- Free colorful inner box.
- Cooling fan built-in.
- 5 years warranty



CORN SERIES LED RETROFIT LIGHT BULBS

- Long life span and less brightness degradation.
- Efficiency of power supply is more than 90%.
- No magnetic disturbance influence.
- No UV and near-IR radiation in the light beam.
- Driver is fulfilled with solid thermal grease.
- Free colorful inner box.
- Cooling fan built-in.
- 5 years warranty

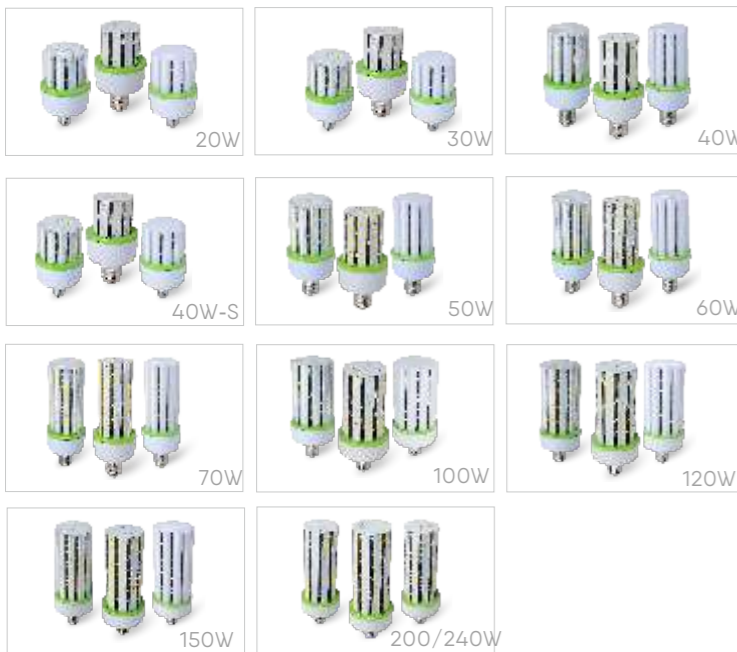

TECHNICAL PARAMETERS

Light Source	SMD 2835
Base	E26 E27 E39 E40
Input Voltage	100-277VAC
CCT	3000K/4000K/5000K/5700K/6500K
CRI	>80
Beam Angle	360°
Lifetime	50,000+ hours
Certificate	ETL cETL DLC SAA CE RoHS



SPECIFICATIONS INFORMATION

Model	Watt	Input Voltage	Efficiency	Lumen	Replacement	Dimensions
LSCB-20WXY	20W	100-277VAC	130LM/W±3%	2,500Lm	75W MH HPS	Dia72*175mm
LSCB-30WXY	30W	100-277VAC	130LM/W±3%	3,750Lm	105W MH HPS	Dia72*200mm
LSCB-40WXY	40W	100-277VAC	130LM/W±3%	5,200Lm	125W MH HPS	Dia105*245mm
LSCB-40WXY-S	40W	100-277VAC	130LM/W±3%	5,200Lm	125W MH HPS	Dia105*185mm
LSCB-50WXY	50W	100-277VAC	130LM/W±3%	6,250Lm	150W MH HPS	Dia105*219mm
LSCB-60WXY	60W	100-277VAC	130LM/W±3%	7,800Lm	180W MH HPS	Dia105*255mm
LSCB-70WXY	70W	100-277VAC	130LM/W±3%	9,100Lm	250W MH HPS	Dia105*291mm
LSCB-100WXY	100W	100-277VAC	130LM/W±3%	13,000Lm	300W MH HPS	Dia128*287mm
LSCB-120WXY	120W	100-277VAC	130LM/W±3%	15,600Lm	350W MH HPS	Dia128*307mm
LSCB-150WXY	150W	100-277VAC	130LM/W±3%	19,500Lm	400W MH HPS	Dia128*337mm
LSCB-200WXY	200W	100-277VAC	130LM/W±3%	24,000Lm	500W MH HPS	Dia128*337mm
LSCB-240WXY	240W	100-277VAC	130LM/W±3%	28,000Lm	600W MH HPS	Dia128*357mm



TECHNICAL PARAMETERS

Light Source	SMD 2835
Base	E26 E27 E39 E40
Input Voltage	347-480VAC
CCT	3000K/4000K/5000K/5700K/6500K
CRI	>80
Beam Angle	360°
Lifetime	50,000+ hours
Certificate	ETL cETL DLC SAA CE RoHS



SPECIFICATIONS INFORMATION

Model	Watt	Input Voltage	Efficiency	Lumen	Replacement	Dimensions
LSCB-20WXY	20W	347-480VAC	130LM/W±3%	2,500Lm	75W MH HPS	Dia72*175mm
LSCB-30WXY	30W	347-480VAC	130LM/W±3%	3,750Lm	105W MH HPS	Dia72*200mm
LSCB-40WXY	40W	347-480VAC	130LM/W±3%	5,200Lm	125W MH HPS	Dia105*245mm
LSCB-40WXY-S	40W	347-480VAC	130LM/W±3%	5,200Lm	125W MH HPS	Dia105*185mm
LSCB-50WXY	50W	347-480VAC	130LM/W±3%	6,250Lm	150W MH HPS	Dia105*219mm
LSCB-60WXY	60W	347-480VAC	130LM/W±3%	7,800Lm	180W MH HPS	Dia105*255mm
LSCB-70WXY	70W	347-480VAC	130LM/W±3%	9,100Lm	250W MH HPS	Dia105*291mm
LSCB-100WXY	100W	347-480VAC	130LM/W±3%	13,000Lm	300W MH HPS	Dia128*287mm
LSCB-120WXY	120W	347-480VAC	130LM/W±3%	15,600Lm	350W MH HPS	Dia128*307mm
LSCB-150WXY	150W	347-480VAC	130LM/W±3%	19,500Lm	400W MH HPS	Dia128*337mm
LSCB-200WXY	200W	347-480VAC	130LM/W±3%	24,000Lm	500W MH HPS	Dia128*337mm
LSCB-240WXY	240W	347-480VAC	130LM/W±3%	28,000Lm	600W MH HPS	Dia128*357mm